

TPS6282x 2.4-V to 5.5-V Input, 1-, 2-, 3-, 4-A Step-down Converter with 1% Output Accuracy

1 Features

- Available as an integrated-inductor power module: [TPSM82821](#) and [TPSM82822](#)
- DCS-Control™ topology
- 1% feedback or output voltage accuracy (full temperature range)
- Up to 97% efficiency
- 26-mΩ and 25-mΩ internal power MOSFETs
- 2.4-V to 5.5-V input voltage range
- 4-μA operating quiescent current
- 2.2-MHz switching frequency
- Adjustable output voltage from 0.6 V to 4 V
- Power save mode for light load efficiency
- 100% duty cycle for lowest dropout
- Active output discharge
- Power good output
- Thermal shutdown protection
- Hiccup short-circuit protection
- A forced-PWM version for CCM operation
- Create a custom design using the TPS6282x with the [WEBENCH® Power Designer](#)

2 Applications

- [Solid state drive](#)
- [Portable electronics](#)
- [Analog security](#) and [IP network](#) cameras
- [Industrial PC](#)
- [Multifunction printers](#)
- Generic point of load

3 Description

The TPS6282x is an easy-to-use synchronous step-down DC-DC converters family with a very low quiescent current of only 4 μA. Based on the DCS-Control topology, it provides a fast transient response. The internal reference allows to regulate the output voltage down to 0.6 V with a high feedback voltage accuracy of 1% over the junction temperature range of –40°C to 125°C. The family devices are pin-to-pin and BOM-to-BOM compatible. The entire solution requires a small 470-nH inductor, a single 4.7-μF input capacitor and two 10-μF or single 22-μF output capacitor.

The TPS6282x is available in two flavors. The first includes an automatically entered power save mode to maintain high efficiency down to very light loads for extending the system battery run-time. The second runs in forced-PWM maintaining a continuous conduction mode to ensure the least ripple in the output voltage and a quasi-fixed switching frequency. The device features a Power Good signal and an internal soft start circuit. It is able to operate in 100% mode. For fault protection, it incorporates a HICCUP short circuit protection as well as a thermal shutdown. The device is available in a 6-pin 1.5 x 1.5-mm QFN package, offering the highest power density solution.

Device Information

| PART NUMBER | PACKAGE ⁽¹⁾ | BODY SIZE (NOM) |
|-------------|------------------------|-----------------|
| TPS62824x | 6-Pin VSON-HR | 1.5 mm x 1.5 mm |
| TPS62825x | | |
| TPS62826x | | |
| TPS62827x | | |

(1) For all available packages, see the orderable addendum at the end of the data sheet.

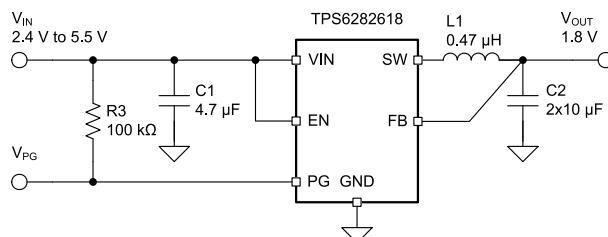

Typical Application Schematic

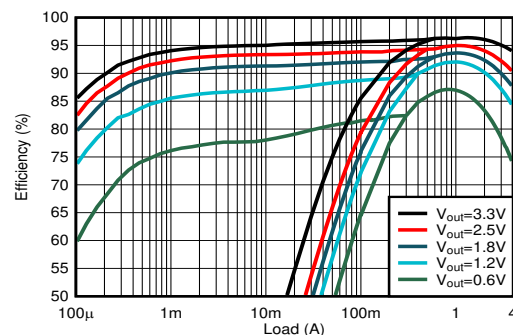

Efficiency at $V_{IN} = 5\text{ V}$



Table of Contents

| | | | |
|--|---|--|----|
| 1 Features | 1 | 8.4 Device Functional Modes..... | 9 |
| 2 Applications | 1 | 9 Application and Implementation | 10 |
| 3 Description | 1 | 9.1 Application Information..... | 10 |
| 4 Revision History | 2 | 9.2 Typical Application..... | 10 |
| 5 Device Options | 3 | 10 Power Supply Recommendations | 21 |
| 6 Pin Configuration and Functions | 3 | 11 Layout | 22 |
| 7 Specifications | 4 | 11.1 Layout Guidelines..... | 22 |
| 7.1 Absolute Maximum Ratings | 4 | 11.2 Layout Example..... | 22 |
| 7.2 ESD Ratings | 4 | 12 Device and Documentation Support | 23 |
| 7.3 Recommended Operating Conditions | 4 | 12.1 Device Support..... | 23 |
| 7.4 Thermal Information | 4 | 12.2 Documentation Support..... | 23 |
| 7.5 Electrical Characteristics | 4 | 12.3 Support Resources..... | 23 |
| 7.6 Typical Characteristics..... | 6 | 12.4 Trademarks..... | 23 |
| 8 Detailed Description | 7 | 12.5 Electrostatic Discharge Caution..... | 23 |
| 8.1 Overview..... | 7 | 12.6 Glossary..... | 23 |
| 8.2 Functional Block Diagram..... | 7 | 13 Mechanical, Packaging, and Orderable Information | 24 |
| 8.3 Feature Description..... | 8 | | |

4 Revision History

| Changes from Revision F (September 2021) to Revision G (March 2022) | Page |
|---|------|
| • Removed "in 1.5-mm × 1.5-mm QFN package" from data sheet title..... | 1 |

| Changes from Revision E (December 2020) to Revision F (September 2021) | Page |
|--|------|
| • Changed the status of the TPS62824DMQ to Production Data..... | 3 |
| • Added the TPS6282533..... | 3 |

5 Device Options

| PART NUMBER | OUTPUT VOLTAGE | OPERATION MODE | OUTPUT CURRENT |
|---------------|----------------|----------------|----------------|
| TPS62824DMQ | Adjustable | PSM/PWM | 1A |
| TPS62825DMQ | Adjustable | | 2 A |
| TPS6282518DMQ | 1.8 V | | |
| TPS6282533DMQ | 3.3 V | | 3 A |
| TPS62826DMQ | Adjustable | | |
| TPS6282618DMQ | 1.8 V | | |
| TPS62827DMQ | Adjustable | | 4 A |
| TPS62824ADMQ | Adjustable | Forced-PWM | 1 A |
| TPS62825ADMQ | Adjustable | | 2 A |
| TPS62826ADMQ | Adjustable | | 3 A |
| TPS62827ADMQ | Adjustable | | 4A |

6 Pin Configuration and Functions

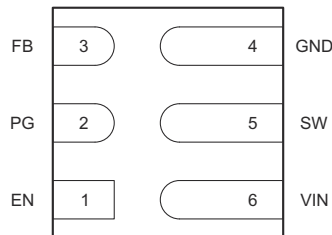

Figure 6-1. DMQ Package 6-Pin VSON-HR Bottom View

Table 6-1. Pin Functions

| PIN | | I/O | DESCRIPTION |
|------|-----|-----|---|
| NAME | NO. | | |
| EN | 1 | I | Device enable pin. To enable the device, this pin needs to be pulled high. Pulling this pin low disables the device. Do not leave floating. |
| PG | 2 | O | Power good open-drain output pin. The pullup resistor can be connected to voltages up to 5.5 V. If unused, leave it floating. |
| FB | 3 | I | Feedback pin. For the fixed output voltage versions, this pin must be connected to the output. |
| GND | 4 | | Ground pin |
| SW | 5 | PWR | Switch pin of the power stage |
| VIN | 6 | PWR | Input voltage pin |

7 Specifications

7.1 Absolute Maximum Ratings

| | | MIN | MAX | UNIT |
|--------------------------------|--|------|-----------------------|------|
| Voltage at Pins ⁽¹⁾ | VIN, FB, EN, PG | -0.3 | 6 | V |
| | SW (DC) | -0.3 | V _{IN} + 0.3 | |
| | SW (DC, in current limit) | -1.0 | V _{IN} + 0.3 | |
| | SW (AC, less than 10ns) ⁽²⁾ | -2.5 | 10 | |
| Temperature | Operating junction temperature, T _J | -40 | 150 | °C |
| | Storage temperature, T _{stg} | -65 | 150 | |

- (1) All voltage values are with respect to network ground terminal.
 (2) While switching.

7.2 ESD Ratings

| | | | VALUE | UNIT |
|--------------------|-------------------------|--|-------|------|
| V _(ESD) | Electrostatic discharge | Human-body model (HBM), per ANSI/ESDA/JEDEC JS-001 ⁽¹⁾ | ±2000 | V |
| | | Charged-device model (CDM), per JEDEC specification JESD22-C101 ⁽²⁾ | ±500 | V |

- (1) JEDEC document JEP155 states that 500-V HBM allows safe manufacturing with a standard ESD control process.
 (2) JEDEC document JEP157 states that 250-V CDM allows safe manufacturing with a standard ESD control process.

7.3 Recommended Operating Conditions

Over operating junction temperature range (unless otherwise noted)

| | | MIN | NOM | MAX | UNIT |
|----------------------|---|-----|-----|-----|------|
| V _{IN} | Input voltage range, TPS62824x, TPS62825x and TPS62826x | 2.4 | | 5.5 | V |
| V _{IN} | Input voltage range, TPS62827x | 2.5 | | 5.5 | V |
| V _{OUT} | Output voltage range | 0.6 | | 4.0 | V |
| I _{OUT} | Output current range, TPS62824x | 0 | | 1 | A |
| I _{OUT} | Output current range, TPS62825x | 0 | | 2 | A |
| I _{OUT} | Output current range, TPS62826x | 0 | | 3 | A |
| I _{OUT} | Output current range, TPS62827x | 0 | | 4 | A |
| I _{SINK_PG} | Sink current at PG pin | | | 1 | mA |
| V _{PG} | Pull-up resistor voltage | | | 5.5 | V |
| T _J | Operating junction temperature | -40 | | 125 | °C |

7.4 Thermal Information

| THERMAL METRIC ⁽¹⁾ | | TPS6282xx | | UNIT |
|-------------------------------|--|-----------------|--------------------|------|
| | | TPS6282x, JEDEC | TPS62826EVM-794 | |
| | | 6 PINS | 6 PINS | |
| R _{θJA} | Junction-to-ambient thermal resistance | 129.5 | 71.4 | °C/W |
| R _{θJC(top)} | Junction-to-case (top) thermal resistance | 103.9 | n/a ⁽²⁾ | °C/W |
| R _{θJB} | Junction-to-board thermal resistance | 33.1 | n/a ⁽²⁾ | °C/W |
| ψ _{JT} | Junction-to-top characterization parameter | 3.8 | 3.9 | °C/W |
| ψ _{JB} | Junction-to-board characterization parameter | 33.1 | 38.6 | °C/W |

- (1) For more information about traditional and new thermal metrics, see the [Semiconductor and IC Package Thermal Metrics](#) application report.
 (2) Not applicable to an EVM.

7.5 Electrical Characteristics

T_J = -40°C to 125°C, and V_{IN} = 2.4 V to 5.5 V. Typical values are at T_J = 25°C and V_{IN} = 5 V, unless otherwise noted.

| PARAMETER | TEST CONDITIONS | MIN | TYP | MAX | UNIT |
|---------------|-----------------|-----|-----|-----|------|
| SUPPLY | | | | | |

$T_J = -40^{\circ}\text{C}$ to 125°C , and $V_{IN} = 2.4\text{ V}$ to 5.5 V . Typical values are at $T_J = 25^{\circ}\text{C}$ and $V_{IN} = 5\text{ V}$, unless otherwise noted.

| PARAMETER | | TEST CONDITIONS | MIN | TYP | MAX | UNIT |
|------------|-----------------------------------|---|-----|------|-----|--------------------|
| I_Q | Quiescent current | EN = High, no load, device not switching | | 4 | 10 | μA |
| I_Q | Quiescent current | EN = High, no load, FPWM devices | | 8 | | mA |
| I_{SD} | Shutdown current | EN = Low, $T_J = -40^{\circ}\text{C}$ to 85°C | | 0.05 | 0.5 | μA |
| V_{UVLO} | Under voltage lock out threshold | V_{IN} falling | 2.1 | 2.2 | 2.3 | V |
| | Under voltage lock out hysteresis | V_{IN} rising | | 160 | | mV |
| T_{JSD} | Thermal shutdown threshold | T_J rising | | 150 | | $^{\circ}\text{C}$ |
| | Thermal shutdown hysteresis | T_J falling | | 20 | | $^{\circ}\text{C}$ |

LOGIC INTERFACE EN

| | | | | | | |
|--------------|-----------------------------------|-----------|-----|------|-----|---------------|
| V_{IH} | High-level threshold voltage | | 1.0 | | | V |
| V_{IL} | Low-level threshold voltage | | | | 0.4 | V |
| $I_{EN,LKG}$ | Input leakage current into EN pin | EN = High | | 0.01 | 0.1 | μA |

SOFT START, POWER GOOD

| | | | | | | |
|--------------|-----------------------------------|---|-----|------|-----|---------------|
| t_{SS} | Soft start time | Time from EN high to 95% of V_{OUT} nominal, TPS62827 | | 1.75 | | ms |
| | | Time from EN high to 95% of V_{OUT} nominal, TPS62824x/5x/6x/7A | | 1.25 | | ms |
| V_{PG} | Power good lower threshold | V_{PG} rising, V_{FB} referenced to V_{FB} nominal | 94 | 96 | 98 | % |
| | | V_{PG} falling, V_{FB} referenced to V_{FB} nominal | 90 | 92 | 94 | % |
| | Power good upper threshold | V_{PG} rising, V_{FB} referenced to V_{FB} nominal | 103 | 105 | 107 | % |
| | | V_{PG} falling, V_{FB} referenced to V_{FB} nominal | 108 | 110 | 112 | % |
| $V_{PG,OL}$ | Low-level output voltage | $I_{sink} = 1\text{ mA}$ | | | 0.4 | V |
| $I_{PG,LKG}$ | Input leakage current into PG pin | $V_{PG} = 5.0\text{ V}$ | | 0.01 | 0.1 | μA |
| $t_{PG,DLY}$ | Power good deglitch delay | PG rising edge | | 100 | | μs |
| | | PG falling edge | | 20 | | |

OUTPUT

| | | | | | | |
|--------------|---|---|-------|------|-------|---------------|
| V_{OUT} | Output voltage accuracy | TPS6282533, PWM mode | 3.267 | 3.3 | 3.333 | V |
| V_{OUT} | Output voltage accuracy | TPS6282x18, PWM mode | 1.78 | 1.8 | 1.82 | V |
| V_{FB} | Feedback regulation voltage | PWM mode | 594 | 600 | 606 | mV |
| $I_{FB,LKG}$ | Feedback input leakage current for adjustable output voltage | $V_{FB} = 0.6\text{ V}$ | | 0.01 | 0.05 | μA |
| R_{FB} | Internal resistor divider connected to FB pin, for fixed output voltage | TPS6282518, TPS6282618, TPS6282533 | | 7.5 | | M Ω |
| I_{DIS} | Output discharge current | $V_{SW} = 0.4\text{V}$; EN = LOW | 75 | 400 | | mA |
| | Load regulation | $I_{OUT} = 0.5\text{ A}$ to 3 A , $V_{OUT} = 1.8\text{ V}$ | | 0.1 | | %/A |

POWER SWITCH

| | | | | | | |
|--------------|---|---|-----|------|-----|------------|
| $R_{DS(on)}$ | High-side FET on-resistance | | | 26 | | m Ω |
| | Low-side FET on-resistance | | | 25 | | m Ω |
| I_{LIM} | High-side FET switch current limit, DC | TPS62824A | 1.7 | 2.1 | 2.4 | A |
| | | TPS62825x | 2.7 | 3.3 | 3.9 | A |
| | | TPS62826x | 3.7 | 4.3 | 5.0 | A |
| | | TPS62827x | 4.8 | 5.6 | 6.4 | A |
| I_{LIM} | Low-side FET negative current limit, DC | TPS62824A/5A/6A/7A | | -1.6 | | A |
| f_{SW} | PWM switching frequency | $I_{OUT} = 1\text{ A}$, $V_{OUT} = 1.8\text{ V}$ | | 2.2 | | MHz |

7.6 Typical Characteristics

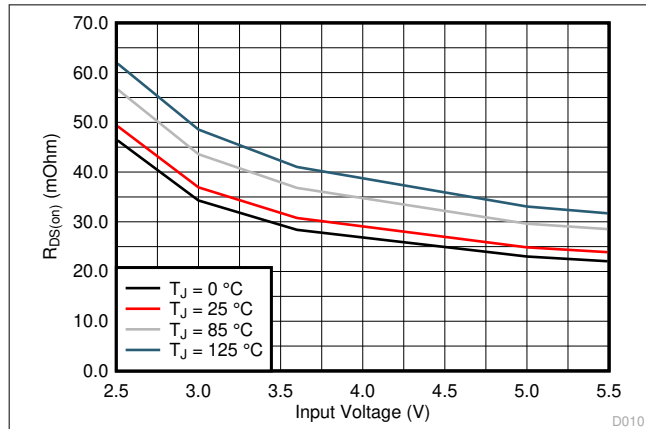

Figure 7-1. High-Side FET On-Resistance

D010

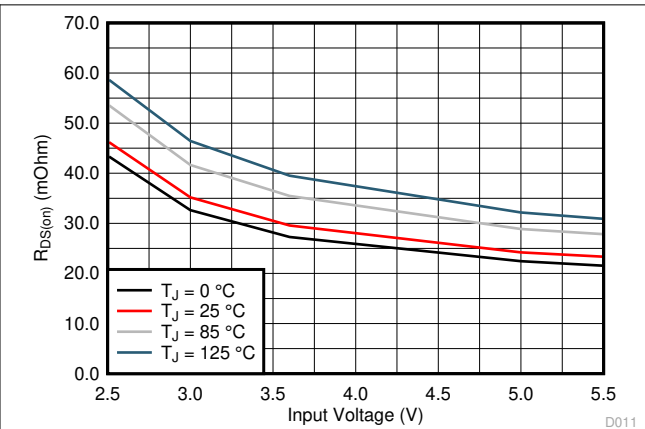

Figure 7-2. Low-Side FET On-Resistance

D011

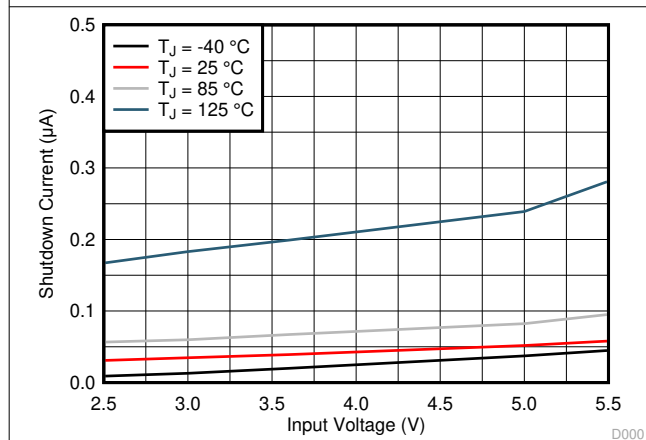

Figure 7-3. Shutdown Current

D000

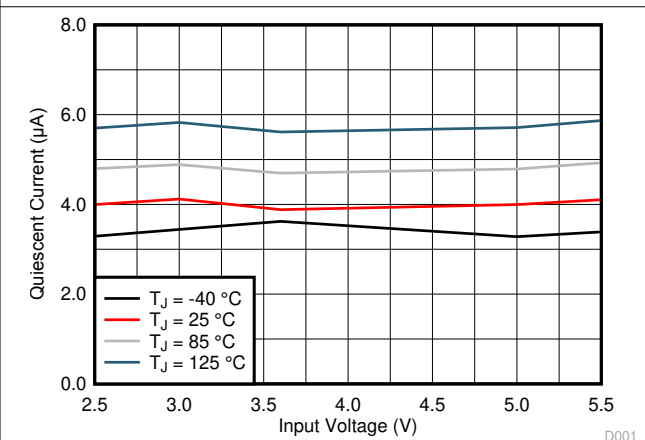

Figure 7-4. Quiescent Current

D001

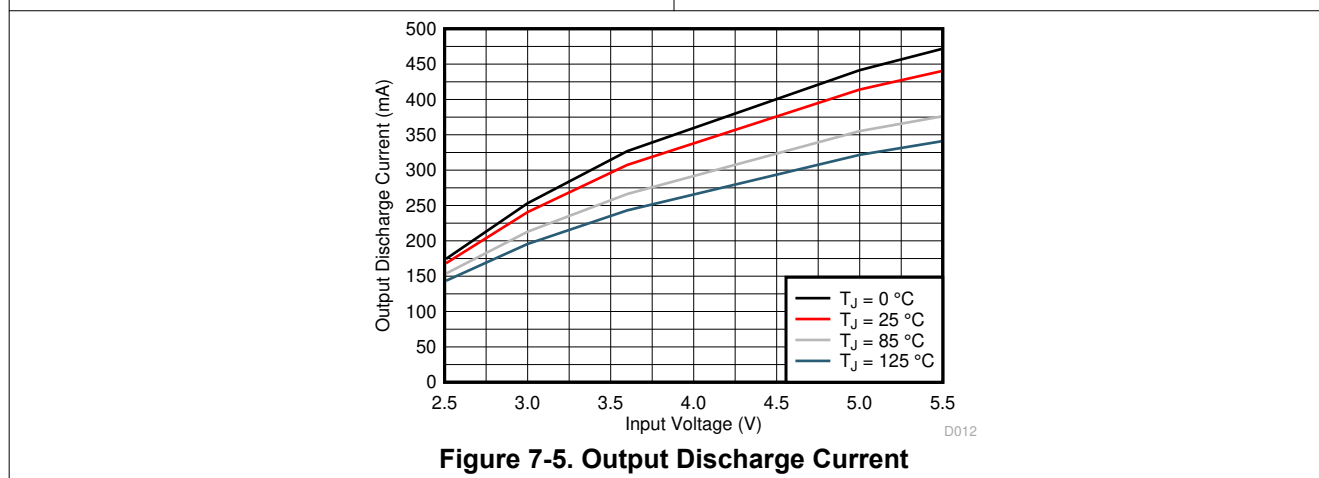

Figure 7-5. Output Discharge Current

D012

8 Detailed Description

8.1 Overview

The TPS6282x are synchronous step-down converters based on the DCS-Control topology with an adaptive constant on-time control and a stabilized switching frequency. It operates in PWM (pulse width modulation) mode for medium to heavy loads and in PSM (power save mode) at light load conditions, keeping the output voltage ripple small. The nominal switching frequency is about 2.2 MHz with a small and controlled variation over the input voltage range. As the load current decreases, the converter enters PSM, reducing the switching frequency to keep efficiency high over the entire load current range. Since combining both PWM and PSM within a single building block, the transition between modes is seamless and without effect on the output voltage. In forced-PWM devices, the converter maintains a continuous conduction mode operation and keeps the output voltage ripple very low across the whole load range and at a nominal switching frequency of 2.2 MHz. The devices offer both excellent dc voltage and fast load transient regulation, combined with a very low output voltage ripple.

8.2 Functional Block Diagram

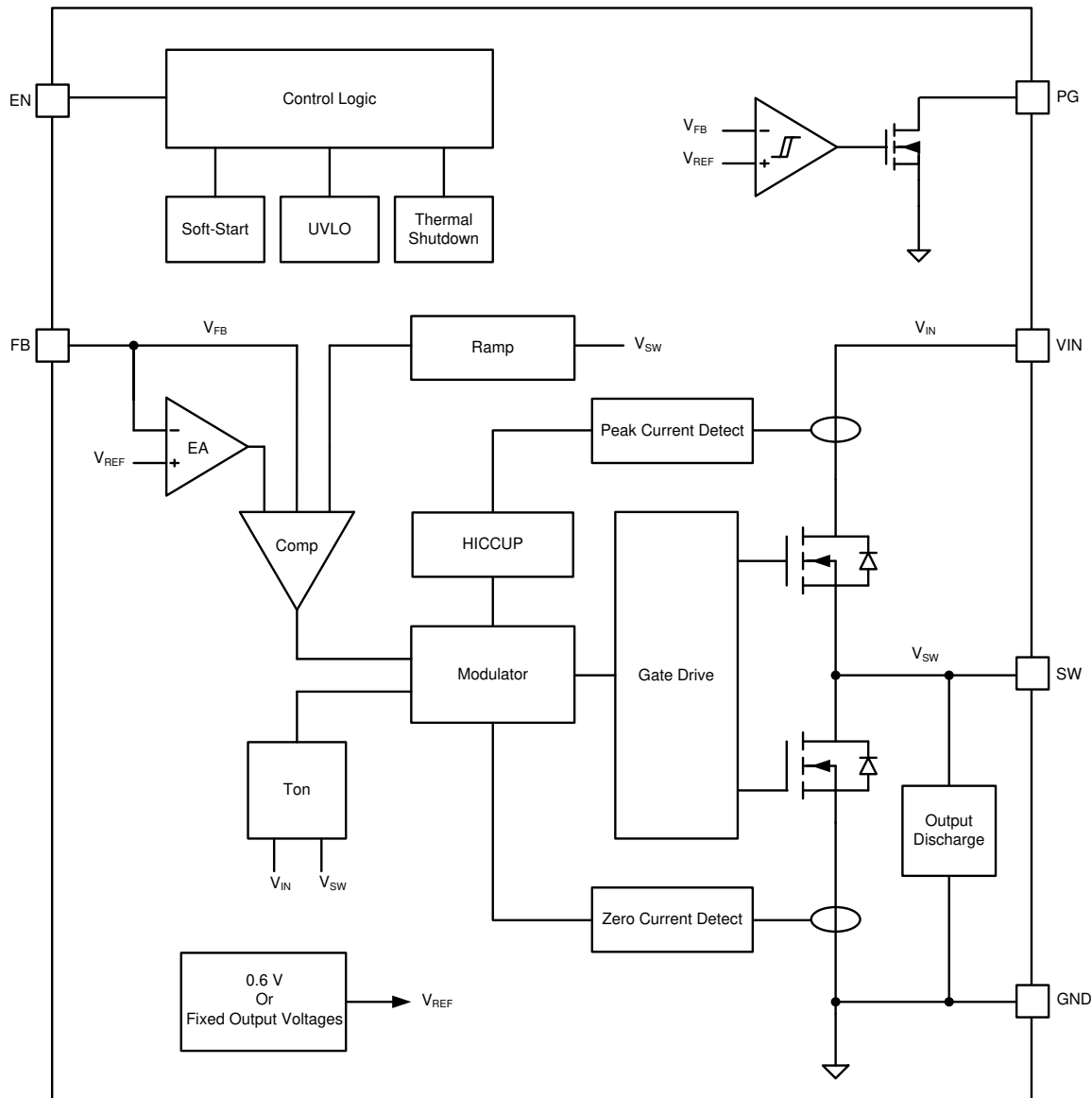

8.3 Feature Description

8.3.1 Pulse Width Modulation (PWM) Operation

At load currents larger than half the inductor ripple current, the device operates in pulse width modulation in continuous conduction mode (CCM). The PWM operation is based on an adaptive constant on-time control with stabilized switching frequency. To achieve a stable switching frequency in a steady state condition, the on-time is calculated as:

$$T_{ON} = \frac{V_{OUT}}{V_{IN}} \cdot 450ns \quad (1)$$

In forced-PWM devices, the device always operates in pulse width modulation in continuous conduction mode (CCM).

8.3.2 Power Save Mode (PSM) Operation

To maintain high efficiency at light loads, the device enters power save mode (PSM) at the boundary to discontinuous conduction mode (DCM). This happens when the output current becomes smaller than half of the ripple current of the inductor. The device operates now with a fixed on-time and the switching frequency further decreases proportional to the load current. It can be calculated as:

$$f_{PSM} = \frac{2 \cdot I_{OUT}}{T_{ON}^2 \cdot \frac{V_{IN}}{V_{OUT}} \left[\frac{V_{IN} - V_{OUT}}{L} \right]} \quad (2)$$

In PSM, the output voltage rises slightly above the nominal target, which can be minimized using larger output capacitance. At duty cycles larger than 90%, the device may not enter PSM. The device maintains output regulation in PWM mode.

8.3.3 Minimum Duty Cycle and 100% Mode Operation

There is no limitation for small duty cycles since even at very low duty cycles, the switching frequency is reduced as needed to always ensure a proper regulation.

If the output voltage level comes close to the input voltage, the device enters 100% mode. While the high-side switch is constantly turned on, the low-side switch is switched off. The difference between VIN and VOUT is determined by the voltage drop across the high-side FET and the DC resistance of the inductor. The minimum VIN that is needed to maintain a specific VOUT value is estimated as:

$$V_{IN,MIN} = V_{OUT} + I_{OUT,MAX} \times (R_{DS(on)} + R_L) \quad (3)$$

where

- $V_{IN,MIN}$ = Minimum input voltage to maintain an output voltage
- $I_{OUT,MAX}$ = Maximum output current
- $R_{DS(on)}$ = High-side FET ON-resistance
- R_L = Inductor ohmic resistance (DCR)

8.3.4 Soft Start

About 250 μ s after EN goes High, the internal soft-start circuitry controls the output voltage during start-up. This avoids excessive inrush current and ensures a controlled output voltage ramp. It also prevents unwanted voltage drops from high-impedance power sources or batteries. The TPS6282x can start into a pre-biased output.

8.3.5 Switch Current Limit and HICCUP Short-Circuit Protection

The switch current limit prevents the device from drawing excessive current in case of externally-caused overcurrent or short circuit condition. Due to an internal propagation delay (typically 60 ns), the actual AC peak current can exceed the static current limit during that time.

If the current limit threshold is reached, the device delivers its maximum output current. Detecting this condition for 32 switching cycles (about 13 μ s), the device turns off the high-side MOSFET for about 100 μ s which allows the inductor current to decrease through the low-side MOSFET's body diode and then restarts again with a soft start cycle. As long as the overload condition is present, the device hiccups that way, limiting the output power.

In forced PWM devices, a negative current limit (I_{LIMN}) is enabled to prevent excessive current flowing backwards to the input. When the inductor current reaches I_{LIMN} , the low-side MOSFET turns off and the high-side MOSFET turns on and kept on until T_{ON} time expires.

8.3.6 Undervoltage Lockout

The undervoltage lockout (UVLO) function prevents misoperation of the device if the input voltage drops below the UVLO threshold. It is set to about 2.2 V with a hysteresis of typically 160 mV.

8.3.7 Thermal Shutdown

The junction temperature (T_J) of the device is monitored by an internal temperature sensor. If T_J exceeds 150°C (typ.), the device goes in thermal shutdown with a hysteresis of typically 20°C. Once T_J has decreased enough, the device resumes normal operation.

8.4 Device Functional Modes

8.4.1 Enable, Disable, and Output Discharge

The device starts operation when Enable (EN) is set High. The input threshold levels are typically 0.9 V for rising and 0.7 V for falling signals. Do not leave EN floating. Shutdown is forced if EN is pulled Low with a shutdown current of typically 50 nA. During shutdown, the internal power MOSFETs as well as the entire control circuitry are turned off and the output voltage is actively discharged through the SW pin by a current sink. Therefore V_{IN} must remain present for the discharge to function.

8.4.2 Power Good

The TPS6282x has a built-in power good (PG) function. The PG pin goes high impedance when the output voltage has reached its nominal value. Otherwise, including when disabled, in UVLO or in thermal shutdown, PG is Low (see [Table 8-1](#)). The PG function is formed with a window comparator, which has an upper and lower voltage threshold. The PG pin is an open-drain output and is specified to sink up to 1 mA. The power good output requires a pullup resistor connecting to any voltage rail less than 5.5 V.

The PG signal can be used for sequencing of multiple rails by connecting it to the EN pin of other converters. Leave the PG pin unconnected when not used. The PG rising edge has a 100- μ s blanking time and the PG falling edge has a deglitch delay of 20 μ s.

Table 8-1. PG Pin Logic

| DEVICE CONDITIONS | | LOGIC STATUS | |
|----------------------|----------------------------------|--------------|-----|
| | | HIGH Z | LOW |
| Enable | EN = High, $V_{FB} \geq 0.576$ V | √ | |
| | EN = High, $V_{FB} \leq 0.552$ V | | √ |
| | EN = High, $V_{FB} \leq 0.63$ V | √ | |
| | EN = High, $V_{FB} \geq 0.66$ V | | √ |
| Shutdown | EN = Low | | √ |
| Thermal Shutdown | $T_J > T_{JSD}$ | | √ |
| UVLO | 0.7 V < V_{IN} < V_{UVLO} | | √ |
| Power Supply Removal | $V_{IN} < 0.7$ V | √ | |

9 Application and Implementation

Note

Information in the following applications sections is not part of the TI component specification, and TI does not warrant its accuracy or completeness. TI's customers are responsible for determining suitability of components for their purposes, as well as validating and testing their design implementation to confirm system functionality.

9.1 Application Information

The following section discusses the design of the external components to complete the power supply design for several input and output voltage options by using typical applications as a reference.

9.2 Typical Application

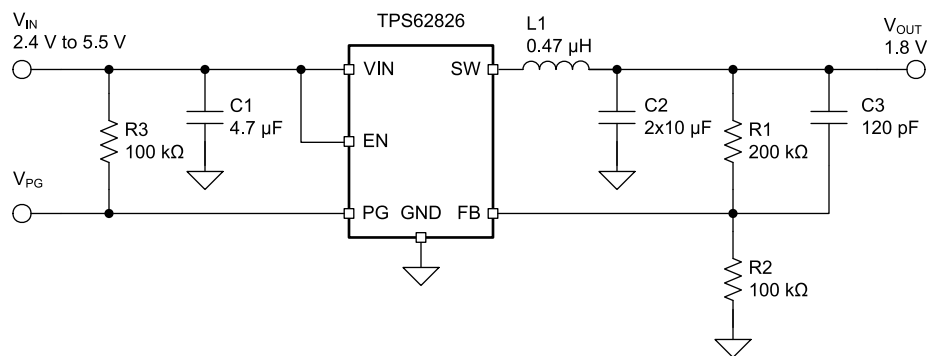

Figure 9-1. Typical Application of TPS62826x

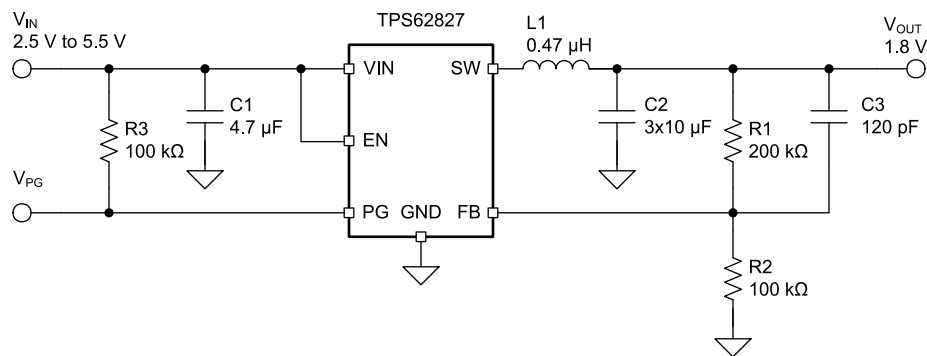

Figure 9-2. Typical Application of TPS62827

9.2.1 Design Requirements

For this design example, use the parameters listed in [Table 9-1](#) as the input parameters.

Table 9-1. Design Parameters

| DESIGN PARAMETER | EXAMPLE VALUE |
|-----------------------------------|----------------|
| Input voltage, TPS62826x | 2.4 V to 5.5 V |
| Input voltage, TPS62827x | 2.5 V to 5.5 V |
| Output voltage | 1.8 V |
| Output ripple voltage | <20 mV |
| Maximum output current, TPS62826x | 3 A |
| Maximum output current, TPS62827x | 4 A |

Table 9-2 lists the components used for the example.

Table 9-2. List of Components

| REFERENCE | DESCRIPTION | MANUFACTURER |
|---------------------------|---|--------------|
| C1 | 4.7 μ F, Ceramic capacitor, 6.3 V, X7R, size 0603, JMK107BB7475MA | Taiyo Yuden |
| C2, TPS62824x/5x/6x/7A | 2 x 10 μ F, Ceramic capacitor, 10 V, X7R, size 0603, GRM188Z71A106MA73D | Murata |
| C2, TPS62827 | 3 x 10 μ F, Ceramic capacitor, 10 V, X7R, size 0603, GRM188Z71A106MA73D | Murata |
| C3 | 120 pF, Ceramic capacitor, 50 V, size 0402 | Std |
| L1 | 0.47 μ H, Power Inductor, XFL4015-471MEB | Coilcraft |
| R1 | Depending on the output voltage, 1%, size 0402 | Std |
| R2 | 100 k Ω , Chip resistor, 1/16 W, 1%, size 0402 | Std |
| R3 | 100 k Ω , Chip resistor, 1/16 W, 1%, size 0402 | Std |

9.2.2 Detailed Design Procedure

9.2.2.1 Custom Design With WEBENCH® Tools

[Click here](#) to create a custom design using the TPS6282x device with the WEBENCH® Power Designer.

1. Start by entering the input voltage (V_{IN}), output voltage (V_{OUT}), and output current (I_{OUT}) requirements.
2. Optimize the design for key parameters such as efficiency, footprint, and cost using the optimizer dial.
3. Compare the generated design with other possible solutions from Texas Instruments.

The WEBENCH Power Designer provides a customized schematic along with a list of materials with real-time pricing and component availability.

In most cases, these actions are available:

- Run electrical simulations to see important waveforms and circuit performance
- Run thermal simulations to understand board thermal performance
- Export customized schematic and layout into popular CAD formats
- Print PDF reports for the design, and share the design with colleagues

Get more information about WEBENCH tools at www.ti.com/WBENCH.

9.2.2.2 Setting The Output Voltage

The output voltage is set by an external resistor divider according to [Equation 4](#):

$$R1 = R2 \times \left(\frac{V_{OUT}}{V_{FB}} - 1 \right) = R2 \times \left(\frac{V_{OUT}}{0.6V} - 1 \right) \quad (4)$$

R2 must not be higher than 100 k Ω to achieve high efficiency at light load while providing acceptable noise sensitivity. [Equation 5](#) shows how to compute the value of the feedforward capacitor for a given R2 value. For the recommended 100k value for R2, a 120-pF feedforward capacitor is used.

$$C3 = \frac{12\mu}{R2} \quad (5)$$

For the fixed output voltage versions, connect the FB pin to the output. R1, R2, and C3 are not needed. The fixed output voltage devices have an internal feedforward capacitor.

9.2.2.3 Output Filter Design

The inductor and the output capacitor together provide a low-pass filter. To simplify this process, [Table 9-3](#) outlines possible inductor and capacitor value combinations for most applications. Checked cells represent combinations that are proven for stability by simulation and lab test. Further combinations should be checked for each individual application.

Table 9-3. Matrix of Output Capacitor and Inductor Combinations, TPS62824x, TPS62825x, TPS62826x and TPS62827A

| NOMINAL L [μ H] ⁽²⁾ | NOMINAL C _{OUT} [μ F] ⁽³⁾ | | | |
|-------------------------------------|--|--------------|----|-----|
| | 10 | 2 x 10 or 22 | 47 | 100 |
| 0.33 | | | | |
| 0.47 | + | +(1) | + | |
| 1.0 | | | | |

- (1) This LC combination is the standard value and recommended for most applications.
 (2) Inductor tolerance and current derating is anticipated. The effective inductance can vary by 20% and –30%.
 (3) Capacitance tolerance and bias voltage derating is anticipated. The effective capacitance can vary by 20% and –35%.

Table 9-4. Matrix of Output Capacitor and Inductor Combinations, TPS62827

| NOMINAL L [μ H] ⁽²⁾ | NOMINAL C _{OUT} [μ F] ⁽³⁾ | | | |
|-------------------------------------|--|--------|----|-----|
| | 22 | 3 x 10 | 47 | 100 |
| 0.33 | | | | |
| 0.47 | | +(1) | + | + |
| 1.0 | | | | |

9.2.2.4 Inductor Selection

The main parameter for the inductor selection is the inductor value and then the saturation current of the inductor. To calculate the maximum inductor current under static load conditions, Equation 6 is given.

$$I_{L,MAX} = I_{OUT,MAX} + \frac{\Delta I_L}{2}$$

$$\Delta I_L = V_{OUT} \times \frac{1 - \frac{V_{OUT}}{V_{IN}}}{L \times f_{SW}} \quad (6)$$

where

- $I_{OUT,MAX}$ = Maximum output current
- ΔI_L = Inductor current ripple
- f_{SW} = Switching frequency
- L = Inductor value

It is recommended to choose a saturation current for the inductor that is approximately 20% to 30% higher than $I_{L,MAX}$. In addition, DC resistance and size should also be taken into account when selecting an appropriate inductor. Table 9-5 lists recommended inductors.

Table 9-5. List of Recommended Inductors

| INDUCTANCE [μ H] | CURRENT RATING [A] | DIMENSIONS [L x W x H mm] | MAX. DC RESISTANCE [m Ω] | MFR PART NUMBER ⁽¹⁾ |
|-----------------------|--------------------|---------------------------|----------------------------------|--------------------------------|
| 0.47 | 4.8 | 2.0 x 1.6 x 1.0 | 32 | HTEN20161T-R47MDR, Cyntec |
| | 4.6 | 2.0 x 1.2 x 1.0 | 25 | HTEH20121T-R47MSR, Cyntec |
| | 4.8 | 2.0 x 1.6 x 1.0 | 32 | DFE201610E - R47M, MuRata |
| | 4.8 | 2.0 x 1.6 x 1.0 | 32 | DFE201210S - R47M, MuRata |
| | 5.1 | 2.0 x 1.6 x 1.0 | 34 | TFM201610ALM-R47MTAA, TDK |
| | 5.2 | 2.0 x 1.6 x 1.0 | 25 | TFM201610ALC-R47MTAA, TDK |
| | 6.6 | 4.0 x 4.0 x 1.6 | 8.36 | XFL4015-471ME, Coilcraft |
| | 8.0 | 3.5 x 3.2 x 2.0 | 10.85 | XEL3520-471ME, Coilcraft |
| | 6.8 | 4.5 x 4 x 1.8 | 11.2 | WE-LHMI-744373240047, Würth |

(1) See the [Third-party Products Disclaimer](#)

9.2.2.5 Capacitor Selection

The input capacitor is the low-impedance energy source for the converters which helps provide stable operation. A low-ESR multilayer ceramic capacitor is recommended for best filtering and must be placed between VIN and GND as close as possible to those pins. For most applications, a minimum effective input capacitance of 3 μ F should be present, though a larger value reduces input current ripple.

The architecture of the device allows the use of tiny ceramic output capacitors with low equivalent series resistance (ESR). These capacitors provide low output voltage ripple and are recommended. To keep its low resistance up to high frequencies and to get narrow capacitance variation with temperature, TI recommends using X7R or X5R dielectrics. Considering the DC-bias derating the capacitance, the minimum effective output capacitance is 10 μ F for TPS62824x, TPS62825x, TPS62826x and TPS62827A and 20 μ F for TPS62827.

A feed forward capacitor is required for the adjustable version, as described in [Section 9.2.2.2](#). This capacitor is not required for the fixed output voltage versions.

9.2.3 Application Curves

$V_{IN} = 5.0\text{ V}$, $V_{OUT} = 1.8\text{ V}$, $T_A = 25^\circ\text{C}$, BOM = [Table 9-2](#), unless otherwise noted.

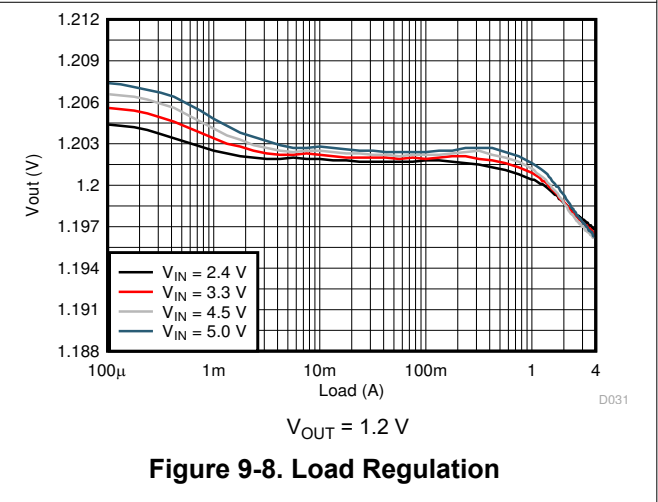
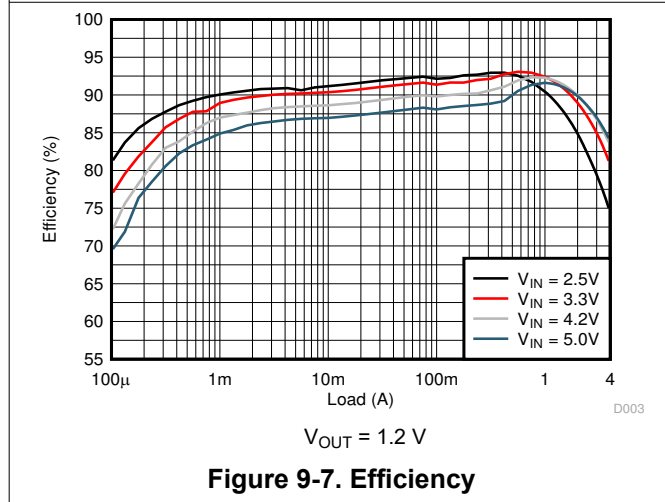
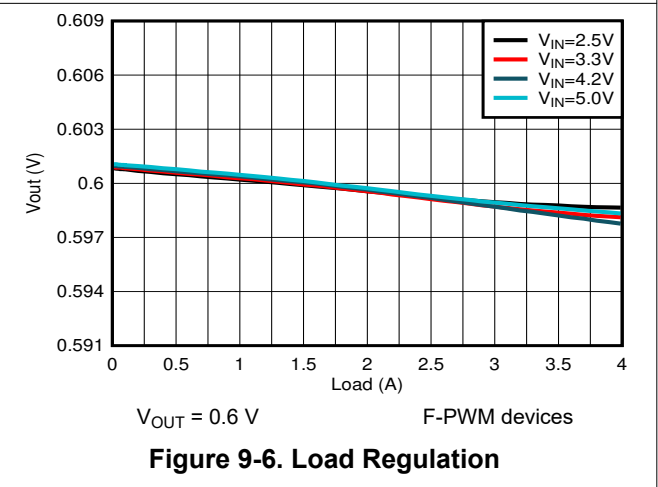
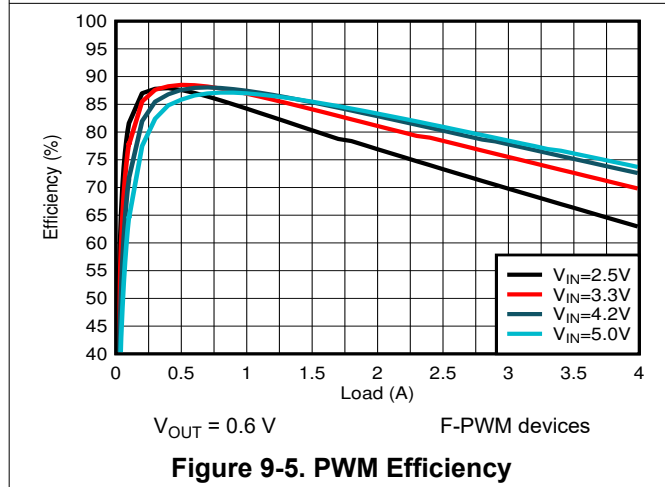
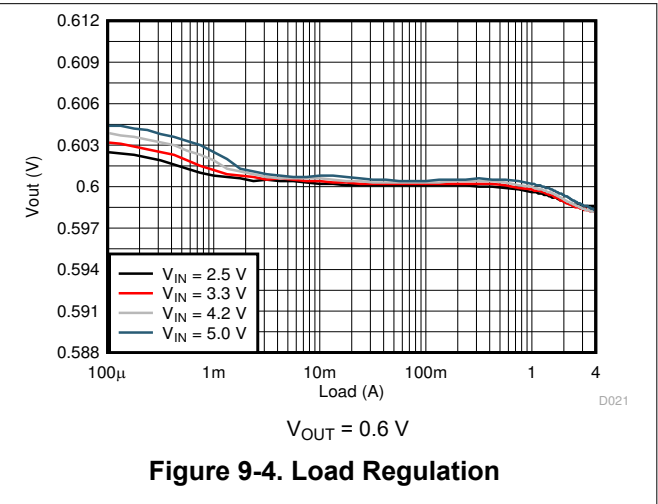
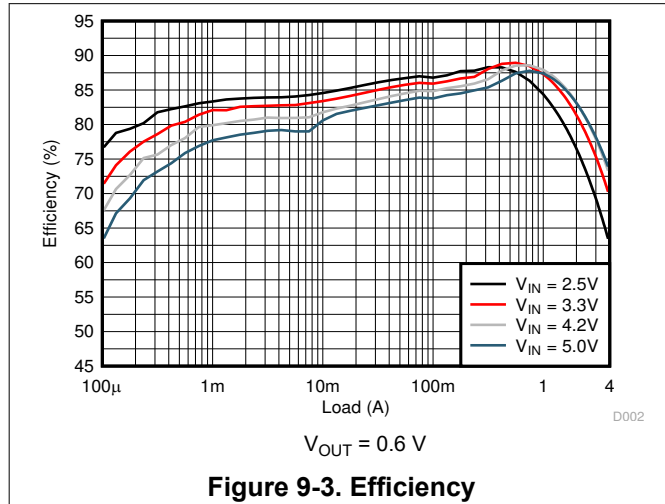

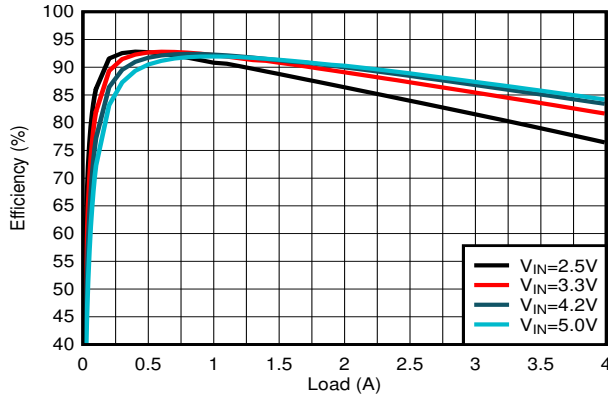

V_{OUT} = 1.2 V F-PWM devices

Figure 9-9. PWM Efficiency

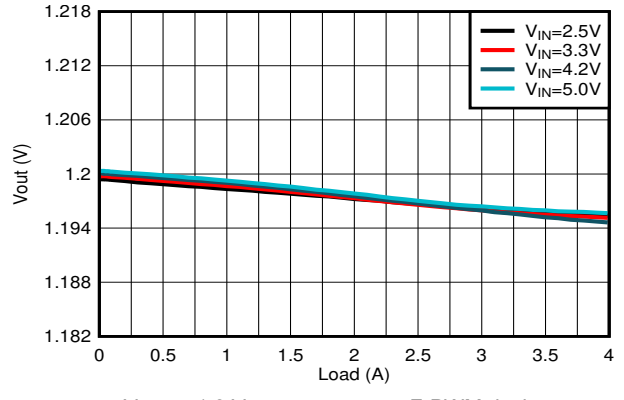

V_{OUT} = 1.2 V F-PWM devices

Figure 9-10. Load Regulation

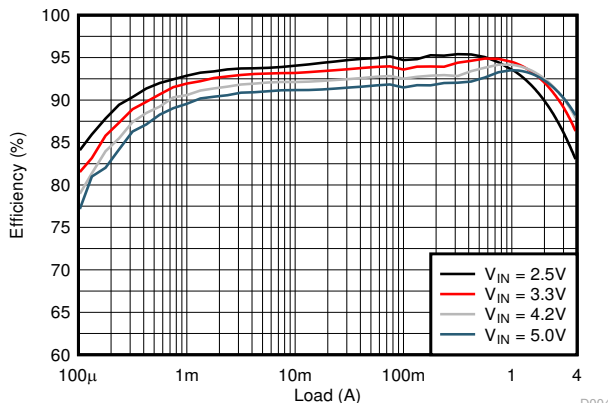

V_{OUT} = 1.8 V

Figure 9-11. Efficiency

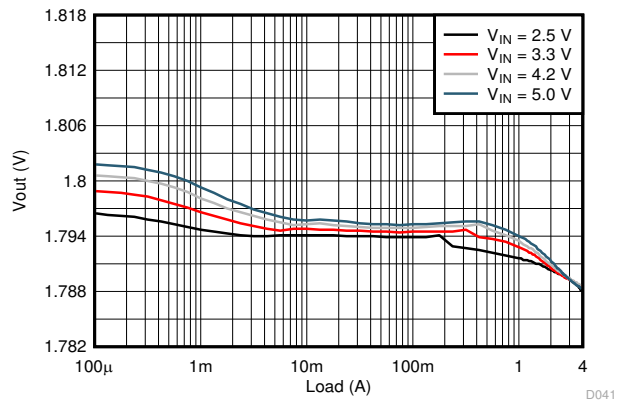

V_{OUT} = 1.8 V

Figure 9-12. Load Regulation

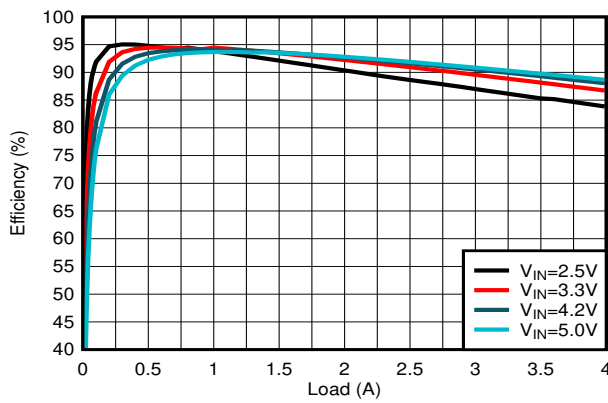

V_{OUT} = 1.8 V F-PWM devices

Figure 9-13. PWM Efficiency

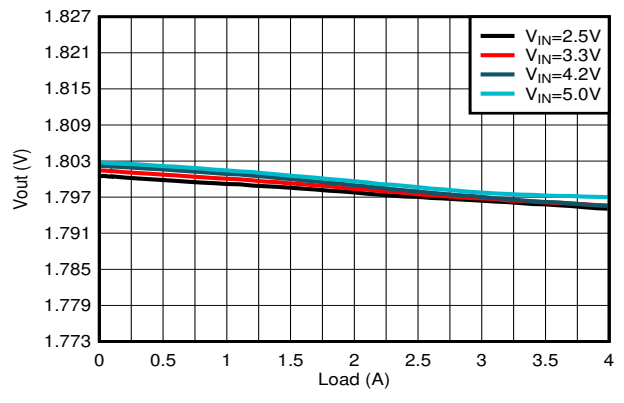

V_{OUT} = 1.8 V F-PWM devices

Figure 9-14. Load Regulation

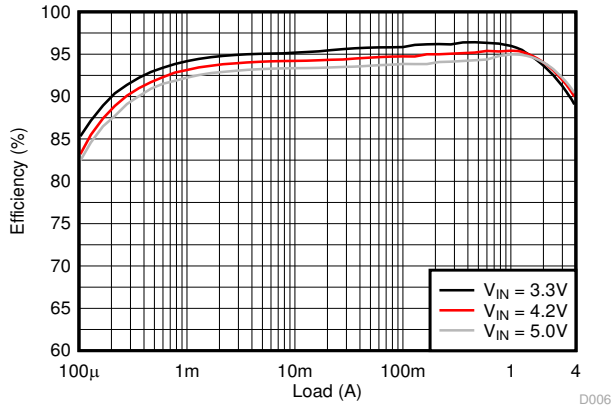

Figure 9-15. Efficiency

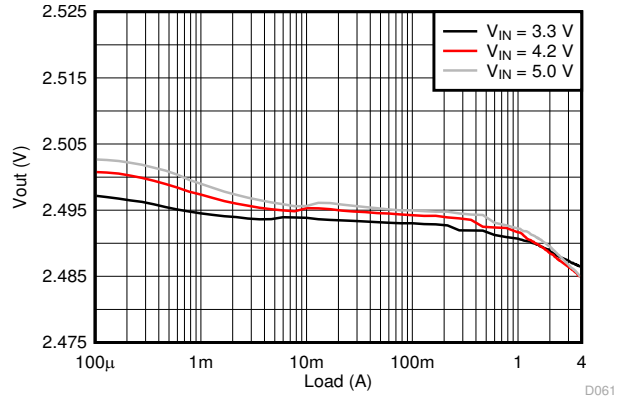

Figure 9-16. Load Regulation

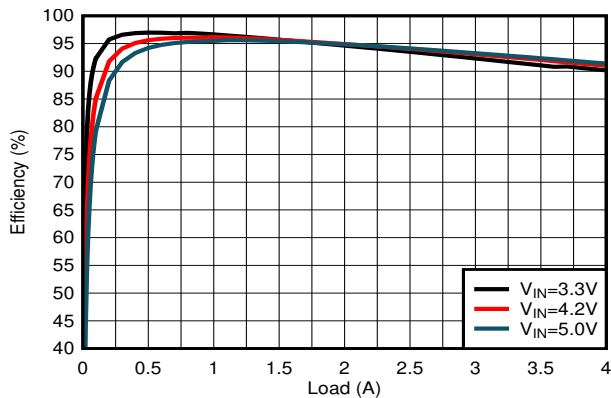

Figure 9-17. PWM Efficiency
 F-PWM devices

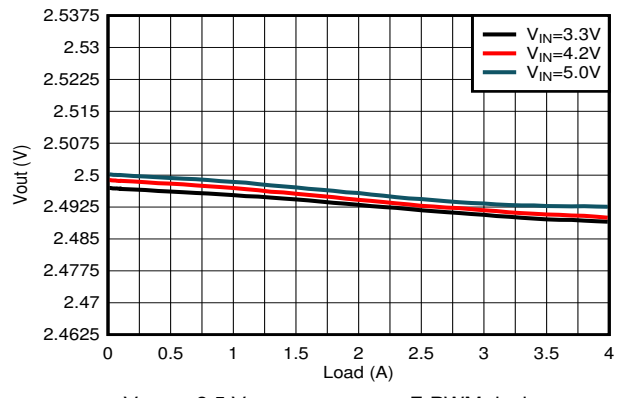

Figure 9-18. Load Regulation
 F-PWM devices

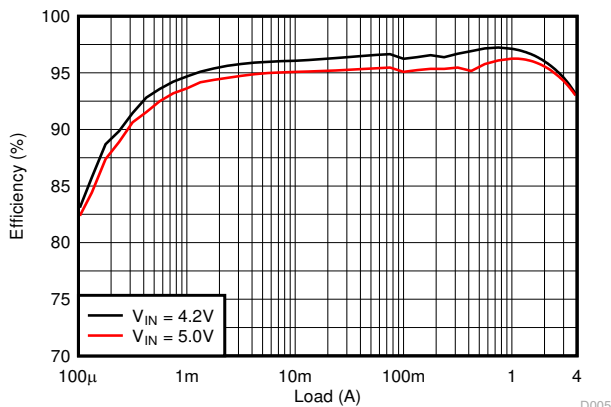

Figure 9-19. Efficiency

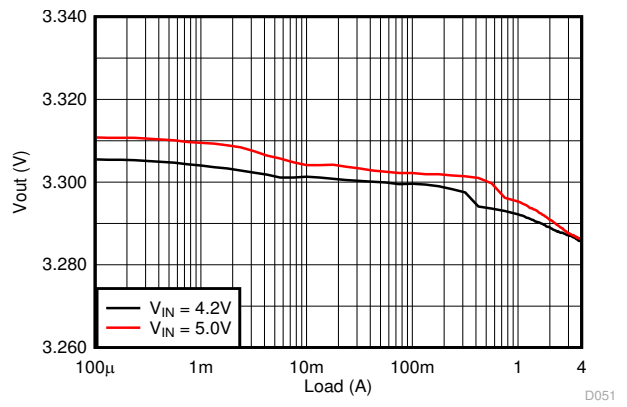
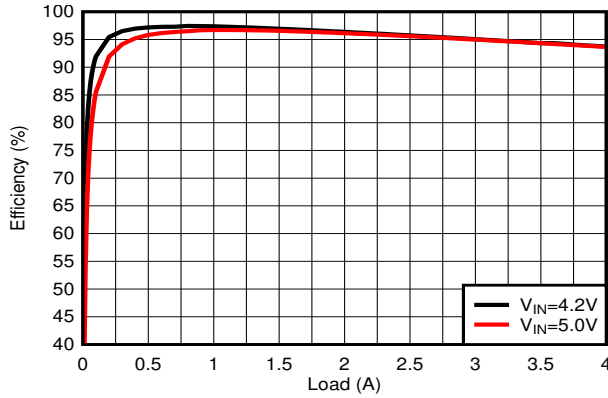
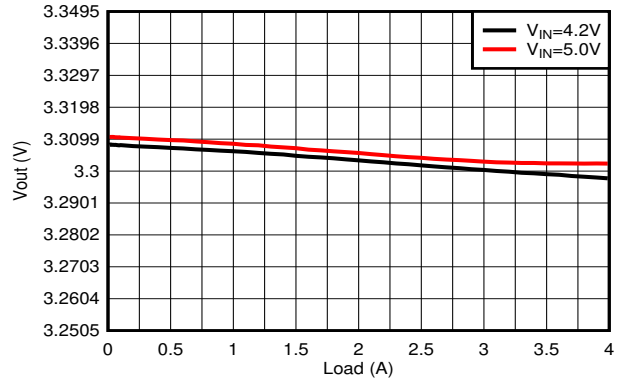

Figure 9-20. Load Regulation



$V_{OUT} = 3.3 V$ F-PWM devices
Figure 9-21. PWM Efficiency



$V_{OUT} = 3.3 V$ F-PWM devices
Figure 9-22. Load Regulation

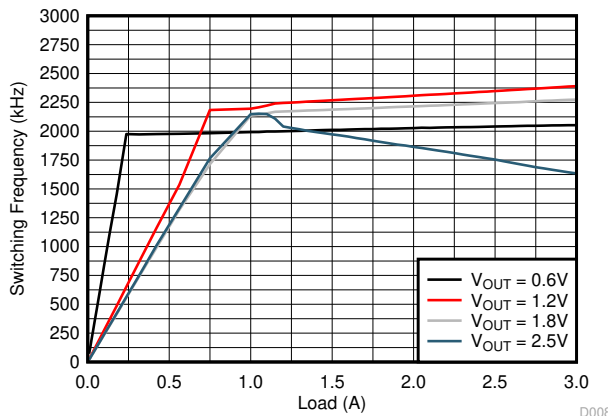

$V_{IN} = 3.3 V$ TPS62824/5/6
Figure 9-23. Switching Frequency

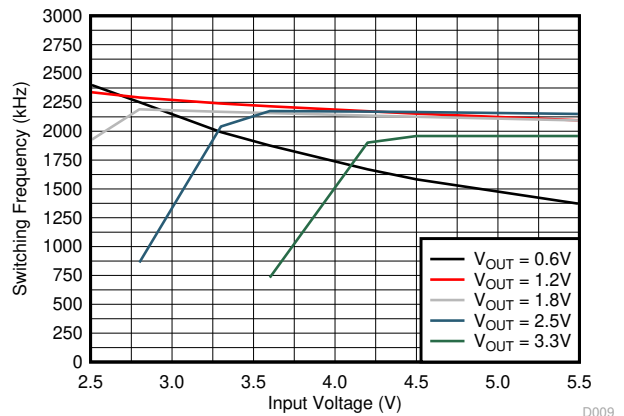

$I_{OUT} = 1.0 A$ TPS62824/5/6
Figure 9-24. Switching Frequency

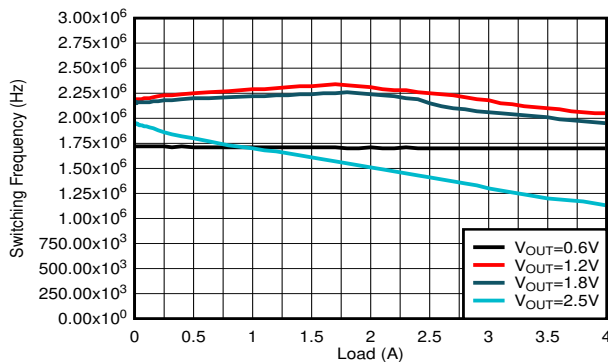

$V_{IN} = 3.3 V$ TPS62824A/5A/6A/7A
Figure 9-25. Switching Frequency

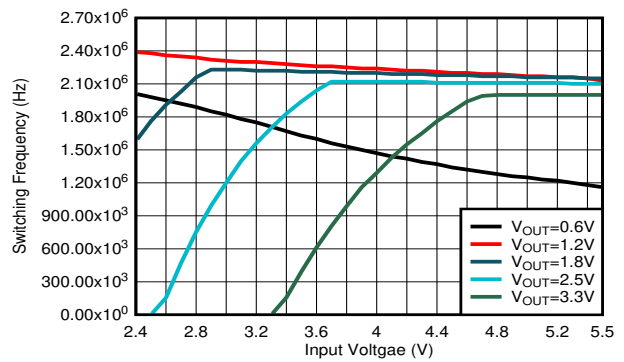

$I_{OUT} = 1.0 A$ TPS62824A/5A/6A/7A
Figure 9-26. Switching Frequency

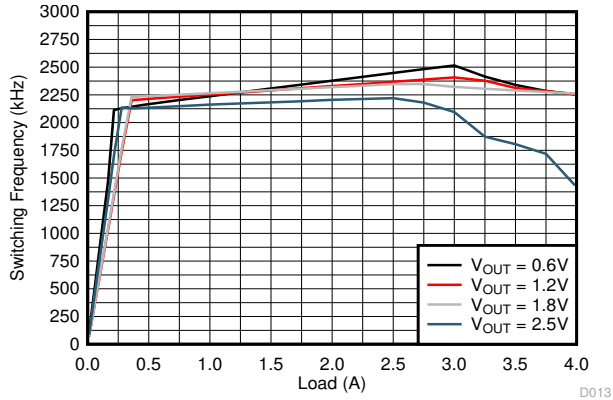

$V_{IN} = 3.3\text{ V}$ **Figure 9-27. Switching Frequency**

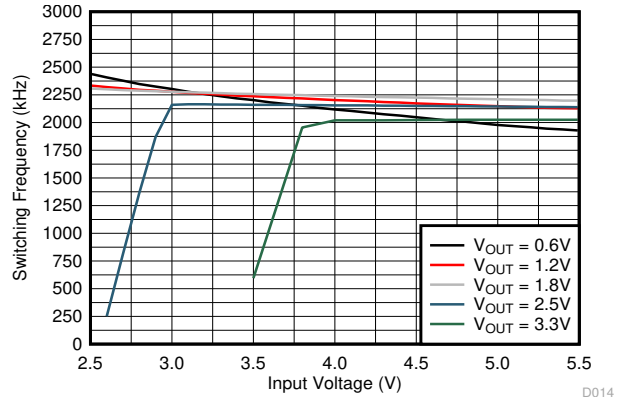

$I_{OUT} = 1.0\text{ A}$ **Figure 9-28. Switching Frequency**

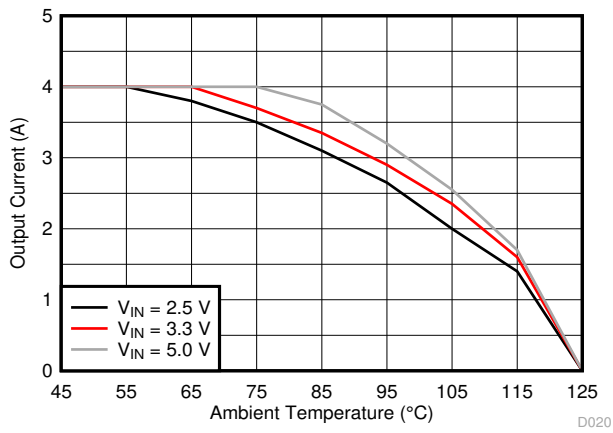

$V_{OUT} = 1.2\text{ V}$ $\theta_{JA} = 71.4^\circ\text{C/W}$ **Figure 9-29. Thermal Derating**

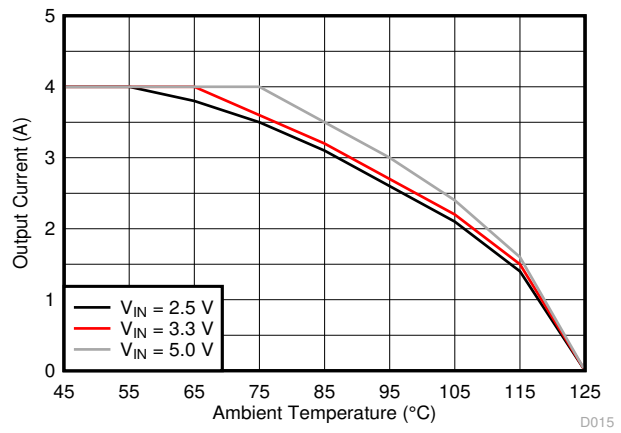

$V_{OUT} = 1.8\text{ V}$ $\theta_{JA} = 71.4^\circ\text{C/W}$ **Figure 9-30. Thermal Derating**

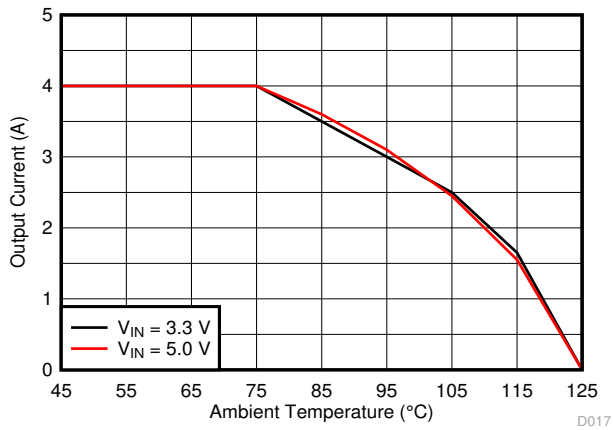

$V_{OUT} = 2.5\text{ V}$ $\theta_{JA} = 71.4^\circ\text{C/W}$ **Figure 9-31. Thermal Derating**

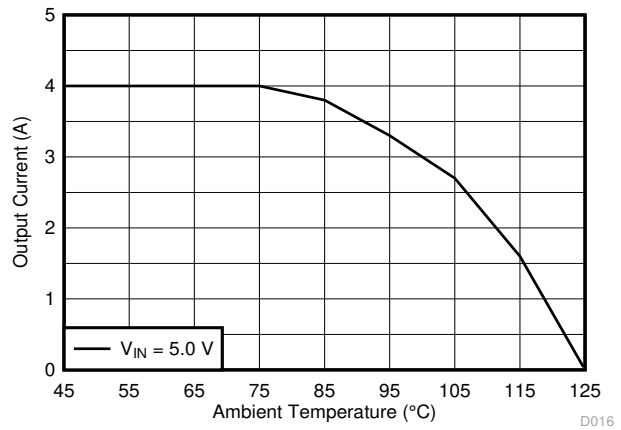

$V_{OUT} = 3.3\text{ V}$ $\theta_{JA} = 71.4^\circ\text{C/W}$ **Figure 9-32. Thermal Derating**

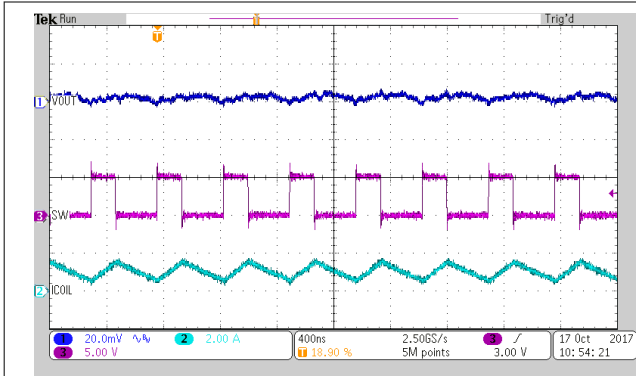

$I_{OUT} = 1.0 \text{ A}$ TPS62824/5/6/7

Figure 9-33. PWM Operation

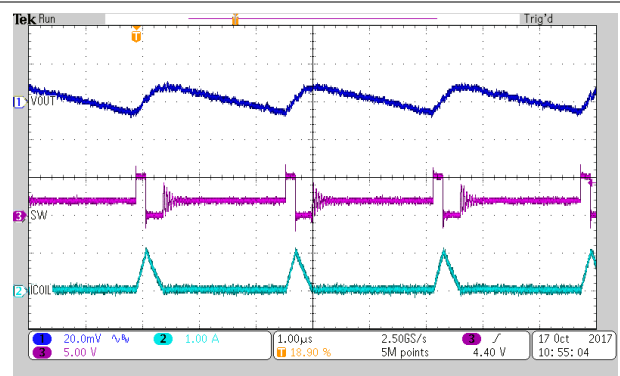

$I_{OUT} = 0.1 \text{ A}$ TPS62824/5/6/7

Figure 9-34. PSM Operation

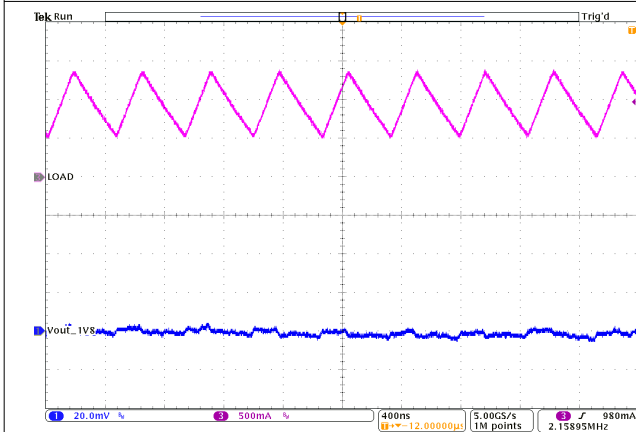

$I_{OUT} = 1.0 \text{ A}$ TPS62824A/5A/6A/7A

Figure 9-35. PWM Operation at F-PWM

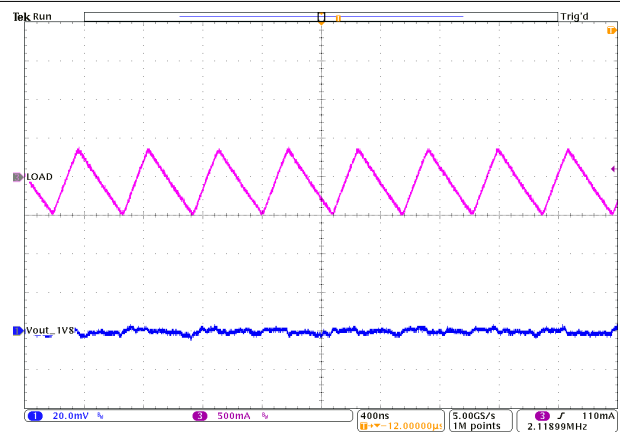

No load TPS62824A/5A/6A/7A

Figure 9-36. PWM Operation at F-PWM

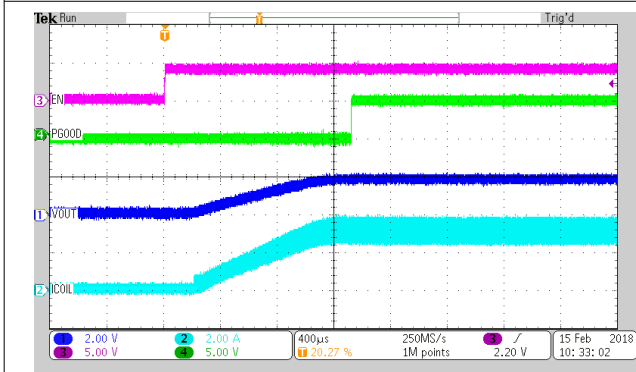

Load = 0.6 Ω TPS62825/6/7

Figure 9-37. Start-up with Load

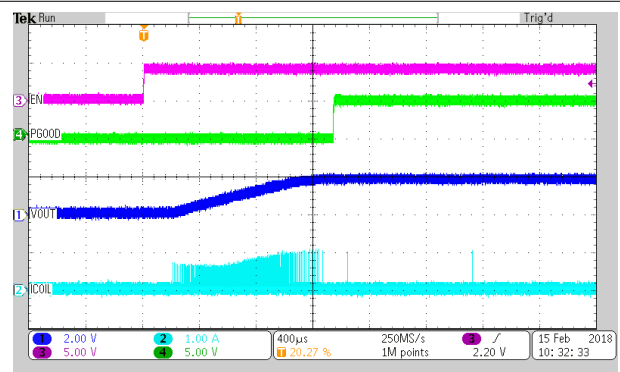

TPS62824/5/6/7

Figure 9-38. Start-up with No Load

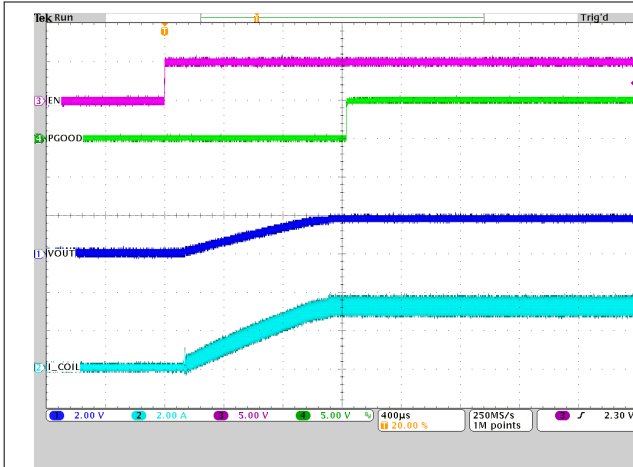

Load = 0.6 Ω TPS62825A/6A/7A

Figure 9-39. Start-up with Load

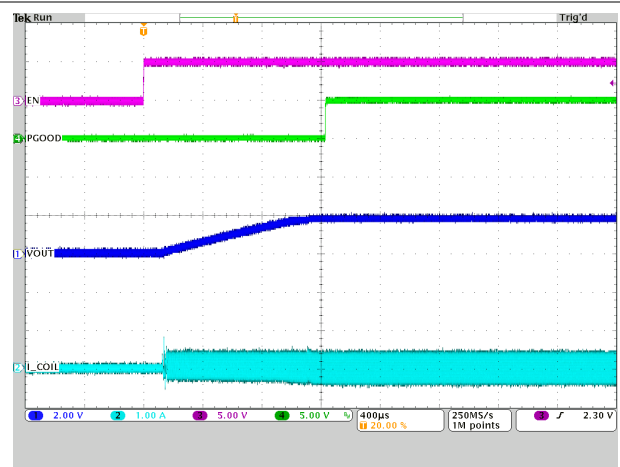

TPS62824A/5A/6A/7A

Figure 9-40. Start-up with No Load

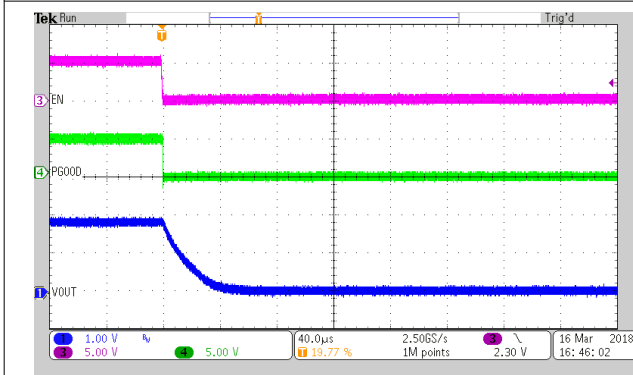

Load = 1.8 Ω TPS6282x

Figure 9-41. Disable, Active Output Discharge

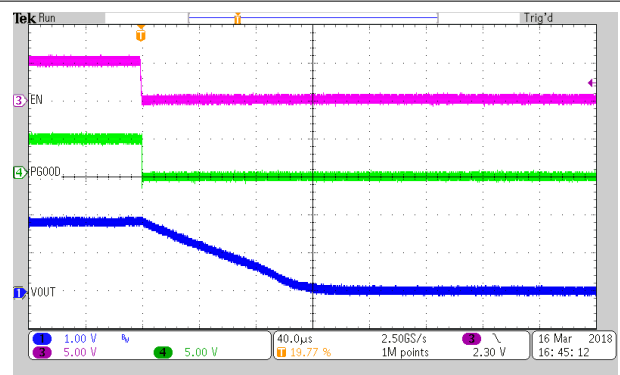

TPS6282x

Figure 9-42. Disable, Active Output Discharge at No Load

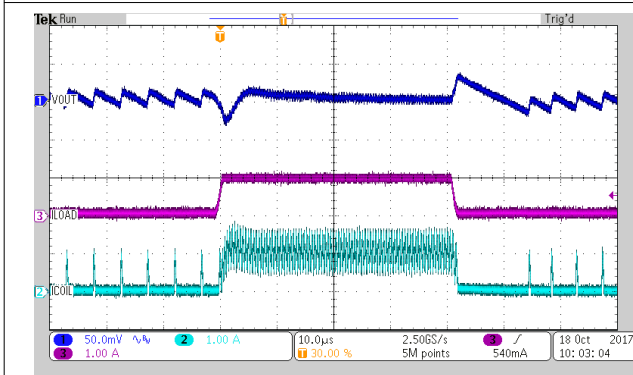

I_{OUT} = 0.05 A to 1A TPS62824/5/6/7

Figure 9-43. Load Transient

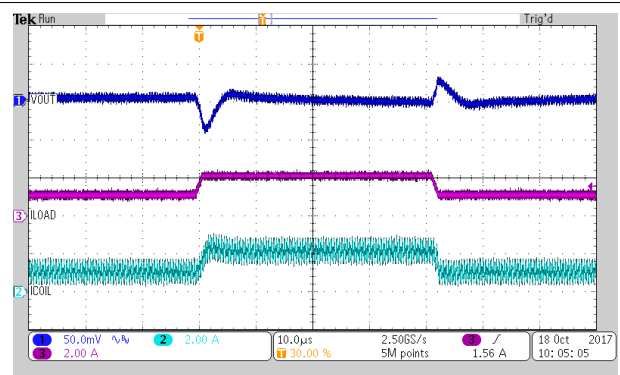

I_{OUT} = 1 A to 2 A TPS62825/6/7

Figure 9-44. Load Transient

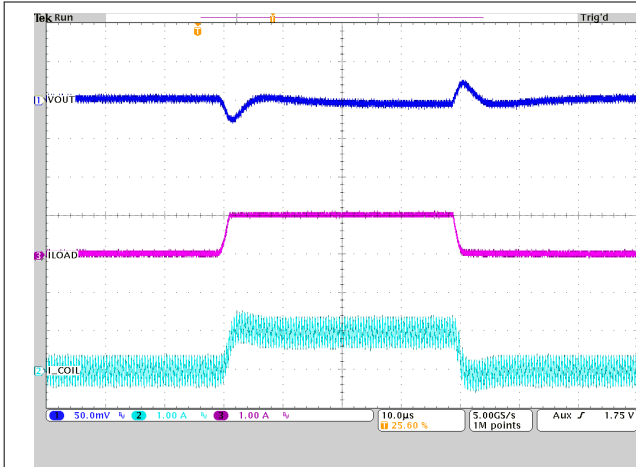

$I_{OUT} = 0.05 \text{ A to } 1 \text{ A}$ TPS62824A/5A/6A/7A

Figure 9-45. Load Transient

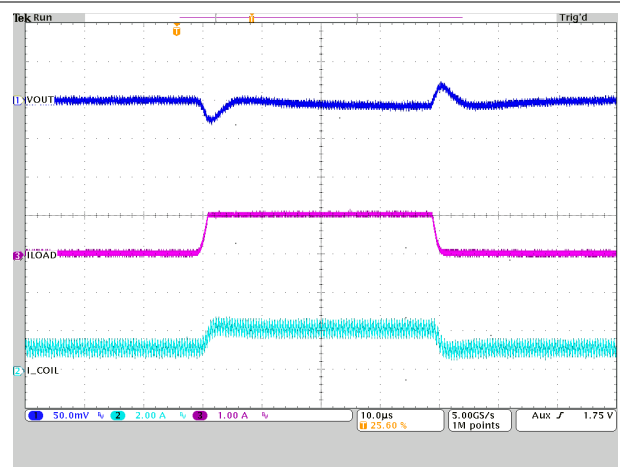

$I_{OUT} = 1 \text{ A to } 2 \text{ A}$ TPS62825A/6A/7A

Figure 9-46. Load Transient

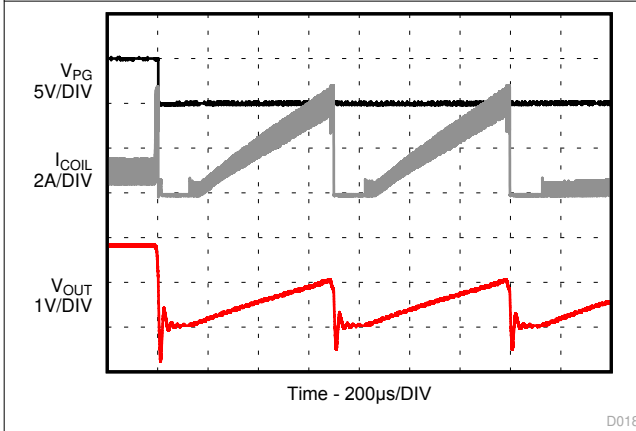

$I_{OUT} = 1 \text{ A}$ TPS6282x

Figure 9-47. HICCUP Short Circuit Protection

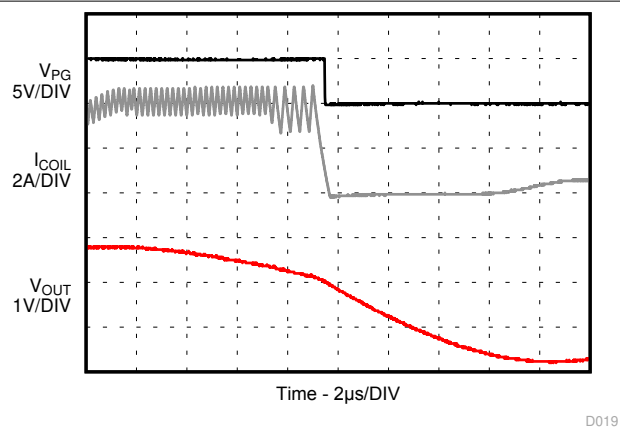

$I_{OUT} = 1 \text{ A}$ TPS6282x

Figure 9-48. HICCUP Short Circuit Protection (Zoom In)

10 Power Supply Recommendations

The device is designed to operate from an input voltage supply range from 2.4 V to 5.5 V. Ensure that the input power supply has a sufficient current rating for the application.

11 Layout

11.1 Layout Guidelines

The printed-circuit-board (PCB) layout is an important step to maintain the high performance of the device. See [Section 11.2](#) for the recommended PCB layout.

- The input/output capacitors and the inductor should be placed as close as possible to the IC. This keeps the power traces short. Routing these power traces direct and wide results in low trace resistance and low parasitic inductance.
- The low side of the input and output capacitors must be connected properly to the GND pin to avoid a ground potential shift.
- The sense traces connected to FB is a signal trace. Special care should be taken to avoid noise being induced. Keep these traces away from SW nodes. The connection of the output voltage trace for the FB resistors should be made at the output capacitor.
- Refer to [Section 11.2](#) for an example of component placement, routing and thermal design.

11.2 Layout Example

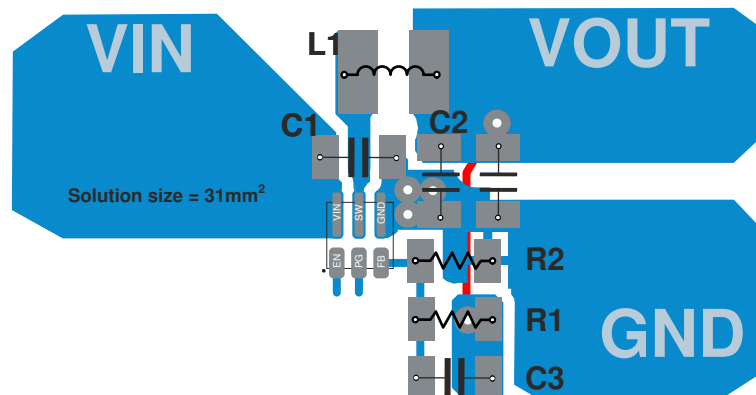

Figure 11-1. PCB Layout Recommendation

11.2.1 Thermal Considerations

Implementation of integrated circuits in low-profile and fine-pitch surface-mount packages typically requires special attention to power dissipation. Many system-dependent issues such as thermal coupling, airflow, added heat sinks and convection surfaces, and the presence of other heat-generating components affect the power dissipation limits of a given component.

Two basic approaches for enhancing thermal performance are:

- Improving the power dissipation capability of the PCB design
- Introducing airflow in the system

The Thermal Data section in [Section 7.4](#) provides the thermal metric of the device on the EVM after considering the PCB design of real applications. The big copper planes connecting to the pads of the IC on the PCB improve the thermal performance of the device. For more details on how to use the thermal parameters, see the *Thermal Characteristics Application Notes*, [SZZA017](#) and [SPRA953](#).

12 Device and Documentation Support

12.1 Device Support

12.1.1 Third-Party Products Disclaimer

TI'S PUBLICATION OF INFORMATION REGARDING THIRD-PARTY PRODUCTS OR SERVICES DOES NOT CONSTITUTE AN ENDORSEMENT REGARDING THE SUITABILITY OF SUCH PRODUCTS OR SERVICES OR A WARRANTY, REPRESENTATION OR ENDORSEMENT OF SUCH PRODUCTS OR SERVICES, EITHER ALONE OR IN COMBINATION WITH ANY TI PRODUCT OR SERVICE.

12.1.2 Development Support

12.1.2.1 Custom Design With WEBENCH® Tools

[Click here](#) to create a custom design using the TPS6282x device with the WEBENCH® Power Designer.

1. Start by entering the input voltage (V_{IN}), output voltage (V_{OUT}), and output current (I_{OUT}) requirements.
2. Optimize the design for key parameters such as efficiency, footprint, and cost using the optimizer dial.
3. Compare the generated design with other possible solutions from Texas Instruments.

The WEBENCH Power Designer provides a customized schematic along with a list of materials with real-time pricing and component availability.

In most cases, these actions are available:

- Run electrical simulations to see important waveforms and circuit performance
- Run thermal simulations to understand board thermal performance
- Export customized schematic and layout into popular CAD formats
- Print PDF reports for the design, and share the design with colleagues

Get more information about WEBENCH tools at www.ti.com/WEBENCH.

12.2 Documentation Support

12.2.1 Related Documentation

For related documentation, see the following:

- *Thermal Characteristics Application Note*, [SZZA017](#)
- *Thermal Characteristics Application Note*, [SPRA953](#)

12.3 Support Resources

[TI E2E™ support forums](#) are an engineer's go-to source for fast, verified answers and design help — straight from the experts. Search existing answers or ask your own question to get the quick design help you need.

Linked content is provided "AS IS" by the respective contributors. They do not constitute TI specifications and do not necessarily reflect TI's views; see TI's [Terms of Use](#).

12.4 Trademarks

DCS-Control™ and TI E2E™ are trademarks of Texas Instruments.

WEBENCH® is a registered trademark of Texas Instruments.

All trademarks are the property of their respective owners.

12.5 Electrostatic Discharge Caution



This integrated circuit can be damaged by ESD. Texas Instruments recommends that all integrated circuits be handled with appropriate precautions. Failure to observe proper handling and installation procedures can cause damage.

ESD damage can range from subtle performance degradation to complete device failure. Precision integrated circuits may be more susceptible to damage because very small parametric changes could cause the device not to meet its published specifications.

12.6 Glossary

[TI Glossary](#) This glossary lists and explains terms, acronyms, and definitions.

13 Mechanical, Packaging, and Orderable Information

The following pages include mechanical, packaging, and orderable information. This information is the most current data available for the designated devices. This data is subject to change without notice and revision of this document. For browser-based versions of this data sheet, refer to the left-hand navigation.

PACKAGING INFORMATION

| Orderable Device | Status (1) | Package Type | Package Drawing | Pins | Package Qty | Eco Plan (2) | Lead finish/ Ball material (6) | MSL Peak Temp (3) | Op Temp (°C) | Device Marking (4/5) | Samples |
|------------------|---------------|--------------|-----------------|------|-------------|-----------------|--------------------------------------|----------------------|--------------|-------------------------|-------------------------|
| TPS62824ADMQR | ACTIVE | VSON-HR | DMQ | 6 | 3000 | RoHS & Green | Call TI SN NIPDAU | Level-1-260C-UNLIM | -40 to 125 | JM | Samples |
| TPS62824DMQR | ACTIVE | VSON-HR | DMQ | 6 | 3000 | RoHS & Green | Call TI SN NIPDAU | Level-1-260C-UNLIM | -40 to 125 | JL | Samples |
| TPS6282518DMQR | ACTIVE | VSON-HR | DMQ | 6 | 3000 | RoHS & Green | Call TI SN | Level-1-260C-UNLIM | -40 to 125 | CJ | Samples |
| TPS6282518DMQT | ACTIVE | VSON-HR | DMQ | 6 | 250 | RoHS & Green | Call TI SN NIPDAU | Level-1-260C-UNLIM | -40 to 125 | CJ | Samples |
| TPS6282533DMQR | ACTIVE | VSON-HR | DMQ | 6 | 3000 | RoHS & Green | Call TI SN NIPDAU | Level-1-260C-UNLIM | -40 to 125 | L1 | Samples |
| TPS62825ADMQR | ACTIVE | VSON-HR | DMQ | 6 | 3000 | RoHS & Green | Call TI SN NIPDAU | Level-1-260C-UNLIM | -40 to 125 | JN | Samples |
| TPS62825DMQR | ACTIVE | VSON-HR | DMQ | 6 | 3000 | RoHS & Green | Call TI SN NIPDAU | Level-1-260C-UNLIM | -40 to 125 | CI | Samples |
| TPS62825DMQT | ACTIVE | VSON-HR | DMQ | 6 | 250 | RoHS & Green | Call TI SN NIPDAU | Level-1-260C-UNLIM | -40 to 125 | CI | Samples |
| TPS6282618DMQR | ACTIVE | VSON-HR | DMQ | 6 | 3000 | RoHS & Green | Call TI SN NIPDAU | Level-1-260C-UNLIM | -40 to 125 | CK | Samples |
| TPS6282618DMQT | ACTIVE | VSON-HR | DMQ | 6 | 250 | RoHS & Green | Call TI SN NIPDAU | Level-1-260C-UNLIM | -40 to 125 | CK | Samples |
| TPS62826ADMQR | ACTIVE | VSON-HR | DMQ | 6 | 3000 | RoHS & Green | Call TI SN NIPDAU | Level-1-260C-UNLIM | -40 to 125 | JO | Samples |
| TPS62826DMQR | ACTIVE | VSON-HR | DMQ | 6 | 3000 | RoHS & Green | Call TI SN | Level-1-260C-UNLIM | -40 to 125 | CL | Samples |
| TPS62826DMQT | ACTIVE | VSON-HR | DMQ | 6 | 250 | RoHS & Green | Call TI SN | Level-1-260C-UNLIM | -40 to 125 | CL | Samples |
| TPS62827ADMQR | ACTIVE | VSON-HR | DMQ | 6 | 3000 | RoHS & Green | NIPDAU SN | Level-1-260C-UNLIM | -40 to 125 | JP | Samples |
| TPS62827DMQR | ACTIVE | VSON-HR | DMQ | 6 | 3000 | RoHS & Green | Call TI SN NIPDAU | Level-1-260C-UNLIM | -40 to 125 | EH | Samples |
| TPS62827DMQT | ACTIVE | VSON-HR | DMQ | 6 | 250 | RoHS & Green | Call TI SN NIPDAU | Level-1-260C-UNLIM | -40 to 125 | EH | Samples |

(1) The marketing status values are defined as follows:

ACTIVE: Product device recommended for new designs.

LIFEBUY: TI has announced that the device will be discontinued, and a lifetime-buy period is in effect.

NRND: Not recommended for new designs. Device is in production to support existing customers, but TI does not recommend using this part in a new design.

PREVIEW: Device has been announced but is not in production. Samples may or may not be available.

OBSELETE: TI has discontinued the production of the device.

(2) **RoHS:** TI defines "RoHS" to mean semiconductor products that are compliant with the current EU RoHS requirements for all 10 RoHS substances, including the requirement that RoHS substance do not exceed 0.1% by weight in homogeneous materials. Where designed to be soldered at high temperatures, "RoHS" products are suitable for use in specified lead-free processes. TI may reference these types of products as "Pb-Free".

RoHS Exempt: TI defines "RoHS Exempt" to mean products that contain lead but are compliant with EU RoHS pursuant to a specific EU RoHS exemption.

Green: TI defines "Green" to mean the content of Chlorine (Cl) and Bromine (Br) based flame retardants meet JS709B low halogen requirements of ≤ 1000 ppm threshold. Antimony trioxide based flame retardants must also meet the ≤ 1000 ppm threshold requirement.

(3) MSL, Peak Temp. - The Moisture Sensitivity Level rating according to the JEDEC industry standard classifications, and peak solder temperature.

(4) There may be additional marking, which relates to the logo, the lot trace code information, or the environmental category on the device.

(5) Multiple Device Markings will be inside parentheses. Only one Device Marking contained in parentheses and separated by a "~" will appear on a device. If a line is indented then it is a continuation of the previous line and the two combined represent the entire Device Marking for that device.

(6) Lead finish/Ball material - Orderable Devices may have multiple material finish options. Finish options are separated by a vertical ruled line. Lead finish/Ball material values may wrap to two lines if the finish value exceeds the maximum column width.

Important Information and Disclaimer: The information provided on this page represents TI's knowledge and belief as of the date that it is provided. TI bases its knowledge and belief on information provided by third parties, and makes no representation or warranty as to the accuracy of such information. Efforts are underway to better integrate information from third parties. TI has taken and continues to take reasonable steps to provide representative and accurate information but may not have conducted destructive testing or chemical analysis on incoming materials and chemicals. TI and TI suppliers consider certain information to be proprietary, and thus CAS numbers and other limited information may not be available for release.

In no event shall TI's liability arising out of such information exceed the total purchase price of the TI part(s) at issue in this document sold by TI to Customer on an annual basis.

TAPE AND REEL INFORMATION

QUADRANT ASSIGNMENTS FOR PIN 1 ORIENTATION IN TAPE

*All dimensions are nominal

| Device | Package Type | Package Drawing | Pins | SPQ | Reel Diameter (mm) | Reel Width W1 (mm) | A0 (mm) | B0 (mm) | K0 (mm) | P1 (mm) | W (mm) | Pin1 Quadrant |
|----------------|--------------|-----------------|------|------|--------------------|--------------------|---------|---------|---------|---------|--------|---------------|
| TPS62824ADMQR | VSON-HR | DMQ | 6 | 3000 | 180.0 | 8.4 | 1.75 | 1.75 | 1.0 | 4.0 | 8.0 | Q2 |
| TPS62824DMQR | VSON-HR | DMQ | 6 | 3000 | 180.0 | 8.4 | 1.7 | 1.7 | 1.14 | 4.0 | 8.0 | Q2 |
| TPS62824DMQR | VSON-HR | DMQ | 6 | 3000 | 180.0 | 8.4 | 1.75 | 1.75 | 1.0 | 4.0 | 8.0 | Q2 |
| TPS6282518DMQR | VSON-HR | DMQ | 6 | 3000 | 180.0 | 8.4 | 1.7 | 1.7 | 1.14 | 4.0 | 8.0 | Q2 |
| TPS6282518DMQR | VSON-HR | DMQ | 6 | 3000 | 180.0 | 8.4 | 1.75 | 1.75 | 1.0 | 4.0 | 8.0 | Q2 |
| TPS6282518DMQT | VSON-HR | DMQ | 6 | 250 | 180.0 | 8.4 | 1.7 | 1.7 | 1.14 | 4.0 | 8.0 | Q2 |
| TPS6282518DMQT | VSON-HR | DMQ | 6 | 250 | 180.0 | 8.4 | 1.75 | 1.75 | 1.0 | 4.0 | 8.0 | Q2 |
| TPS6282533DMQR | VSON-HR | DMQ | 6 | 3000 | 180.0 | 8.4 | 1.75 | 1.75 | 1.0 | 4.0 | 8.0 | Q2 |
| TPS6282533DMQR | VSON-HR | DMQ | 6 | 3000 | 180.0 | 8.4 | 1.7 | 1.7 | 1.14 | 4.0 | 8.0 | Q2 |

| Device | Package Type | Package Drawing | Pins | SPQ | Reel Diameter (mm) | Reel Width W1 (mm) | A0 (mm) | B0 (mm) | K0 (mm) | P1 (mm) | W (mm) | Pin1 Quadrant |
|----------------|--------------|-----------------|------|------|--------------------|--------------------|---------|---------|---------|---------|--------|---------------|
| TPS62825ADMQR | VSON-HR | DMQ | 6 | 3000 | 180.0 | 8.4 | 1.75 | 1.75 | 1.0 | 4.0 | 8.0 | Q2 |
| TPS62825DMQR | VSON-HR | DMQ | 6 | 3000 | 180.0 | 8.4 | 1.7 | 1.7 | 1.14 | 4.0 | 8.0 | Q2 |
| TPS62825DMQR | VSON-HR | DMQ | 6 | 3000 | 180.0 | 8.4 | 1.75 | 1.75 | 1.0 | 4.0 | 8.0 | Q2 |
| TPS62825DMQT | VSON-HR | DMQ | 6 | 250 | 180.0 | 8.4 | 1.7 | 1.7 | 1.14 | 4.0 | 8.0 | Q2 |
| TPS62825DMQT | VSON-HR | DMQ | 6 | 250 | 180.0 | 8.4 | 1.75 | 1.75 | 1.0 | 4.0 | 8.0 | Q2 |
| TPS6282618DMQR | VSON-HR | DMQ | 6 | 3000 | 180.0 | 8.4 | 1.75 | 1.75 | 1.0 | 4.0 | 8.0 | Q2 |
| TPS6282618DMQR | VSON-HR | DMQ | 6 | 3000 | 180.0 | 8.4 | 1.7 | 1.7 | 1.14 | 4.0 | 8.0 | Q2 |
| TPS6282618DMQT | VSON-HR | DMQ | 6 | 250 | 180.0 | 8.4 | 1.75 | 1.75 | 1.0 | 4.0 | 8.0 | Q2 |
| TPS6282618DMQT | VSON-HR | DMQ | 6 | 250 | 180.0 | 8.4 | 1.7 | 1.7 | 1.14 | 4.0 | 8.0 | Q2 |
| TPS62826ADMQR | VSON-HR | DMQ | 6 | 3000 | 180.0 | 8.4 | 1.75 | 1.75 | 1.0 | 4.0 | 8.0 | Q2 |
| TPS62826DMQR | VSON-HR | DMQ | 6 | 3000 | 180.0 | 8.4 | 1.75 | 1.75 | 1.0 | 4.0 | 8.0 | Q2 |
| TPS62826DMQR | VSON-HR | DMQ | 6 | 3000 | 180.0 | 8.4 | 1.7 | 1.7 | 1.14 | 4.0 | 8.0 | Q2 |
| TPS62826DMQT | VSON-HR | DMQ | 6 | 250 | 180.0 | 8.4 | 1.75 | 1.75 | 1.0 | 4.0 | 8.0 | Q2 |
| TPS62826DMQT | VSON-HR | DMQ | 6 | 250 | 180.0 | 8.4 | 1.7 | 1.7 | 1.14 | 4.0 | 8.0 | Q2 |
| TPS62827ADMQR | VSON-HR | DMQ | 6 | 3000 | 180.0 | 8.4 | 1.75 | 1.75 | 1.0 | 4.0 | 8.0 | Q2 |
| TPS62827DMQR | VSON-HR | DMQ | 6 | 3000 | 180.0 | 8.4 | 1.7 | 1.7 | 1.14 | 4.0 | 8.0 | Q2 |
| TPS62827DMQR | VSON-HR | DMQ | 6 | 3000 | 180.0 | 8.4 | 1.75 | 1.75 | 1.0 | 4.0 | 8.0 | Q2 |
| TPS62827DMQT | VSON-HR | DMQ | 6 | 250 | 180.0 | 8.4 | 1.7 | 1.7 | 1.14 | 4.0 | 8.0 | Q2 |

TAPE AND REEL BOX DIMENSIONS

*All dimensions are nominal

| Device | Package Type | Package Drawing | Pins | SPQ | Length (mm) | Width (mm) | Height (mm) |
|----------------|--------------|-----------------|------|------|-------------|------------|-------------|
| TPS62824ADMQR | VSON-HR | DMQ | 6 | 3000 | 210.0 | 185.0 | 35.0 |
| TPS62824DMQR | VSON-HR | DMQ | 6 | 3000 | 182.0 | 182.0 | 20.0 |
| TPS62824DMQR | VSON-HR | DMQ | 6 | 3000 | 210.0 | 185.0 | 35.0 |
| TPS6282518DMQR | VSON-HR | DMQ | 6 | 3000 | 182.0 | 182.0 | 20.0 |
| TPS6282518DMQR | VSON-HR | DMQ | 6 | 3000 | 210.0 | 185.0 | 35.0 |
| TPS6282518DMQT | VSON-HR | DMQ | 6 | 250 | 182.0 | 182.0 | 20.0 |
| TPS6282518DMQT | VSON-HR | DMQ | 6 | 250 | 210.0 | 185.0 | 35.0 |
| TPS6282533DMQR | VSON-HR | DMQ | 6 | 3000 | 210.0 | 185.0 | 35.0 |
| TPS6282533DMQR | VSON-HR | DMQ | 6 | 3000 | 182.0 | 182.0 | 20.0 |
| TPS62825ADMQR | VSON-HR | DMQ | 6 | 3000 | 210.0 | 185.0 | 35.0 |
| TPS62825DMQR | VSON-HR | DMQ | 6 | 3000 | 182.0 | 182.0 | 20.0 |
| TPS62825DMQR | VSON-HR | DMQ | 6 | 3000 | 210.0 | 185.0 | 35.0 |
| TPS62825DMQT | VSON-HR | DMQ | 6 | 250 | 182.0 | 182.0 | 20.0 |
| TPS62825DMQT | VSON-HR | DMQ | 6 | 250 | 210.0 | 185.0 | 35.0 |
| TPS6282618DMQR | VSON-HR | DMQ | 6 | 3000 | 210.0 | 185.0 | 35.0 |
| TPS6282618DMQR | VSON-HR | DMQ | 6 | 3000 | 182.0 | 182.0 | 20.0 |
| TPS6282618DMQT | VSON-HR | DMQ | 6 | 250 | 210.0 | 185.0 | 35.0 |
| TPS6282618DMQT | VSON-HR | DMQ | 6 | 250 | 182.0 | 182.0 | 20.0 |

| Device | Package Type | Package Drawing | Pins | SPQ | Length (mm) | Width (mm) | Height (mm) |
|---------------|--------------|-----------------|------|------|-------------|------------|-------------|
| TPS62826ADMQR | VSON-HR | DMQ | 6 | 3000 | 210.0 | 185.0 | 35.0 |
| TPS62826DMQR | VSON-HR | DMQ | 6 | 3000 | 210.0 | 185.0 | 35.0 |
| TPS62826DMQR | VSON-HR | DMQ | 6 | 3000 | 182.0 | 182.0 | 20.0 |
| TPS62826DMQT | VSON-HR | DMQ | 6 | 250 | 210.0 | 185.0 | 35.0 |
| TPS62826DMQT | VSON-HR | DMQ | 6 | 250 | 182.0 | 182.0 | 20.0 |
| TPS62827ADMQR | VSON-HR | DMQ | 6 | 3000 | 210.0 | 185.0 | 35.0 |
| TPS62827DMQR | VSON-HR | DMQ | 6 | 3000 | 182.0 | 182.0 | 20.0 |
| TPS62827DMQR | VSON-HR | DMQ | 6 | 3000 | 210.0 | 185.0 | 35.0 |
| TPS62827DMQT | VSON-HR | DMQ | 6 | 250 | 182.0 | 182.0 | 20.0 |

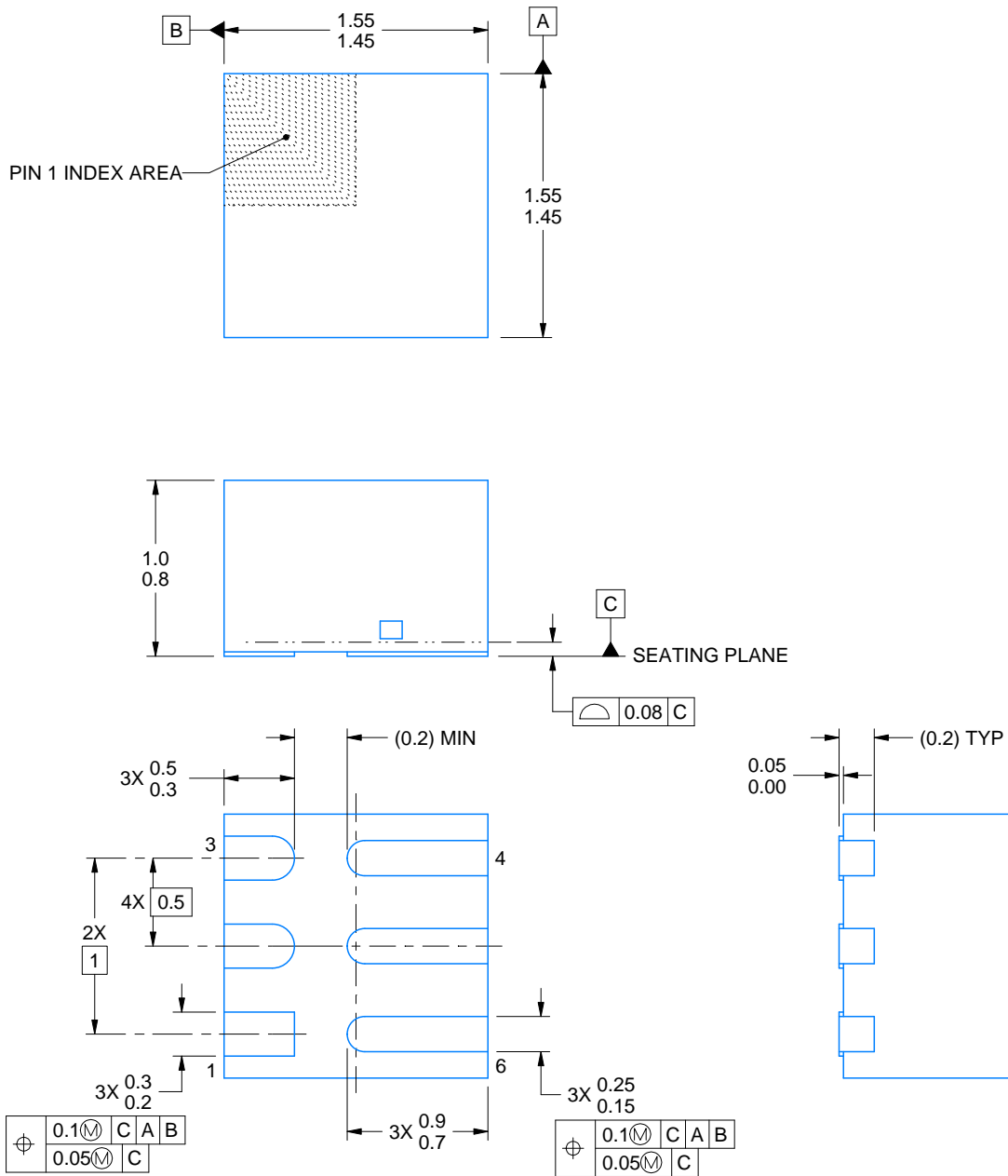
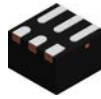

4222645/D 05/2022

NOTES:

1. All linear dimensions are in millimeters. Any dimensions in parenthesis are for reference only. Dimensioning and tolerancing per ASME Y14.5M.
2. This drawing is subject to change without notice.

EXAMPLE BOARD LAYOUT

DMQ0006A

VSON - 1 mm max height

PLASTIC SMALL OUTLINE - NO LEAD

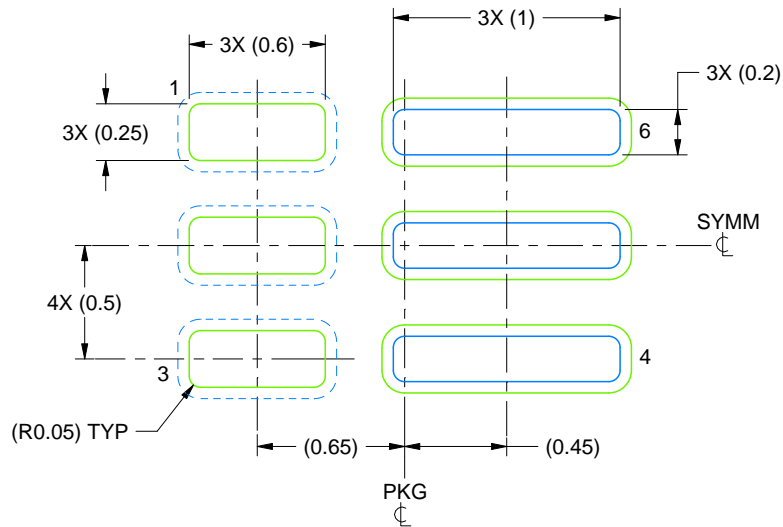

LAND PATTERN EXAMPLE
SCALE:30X

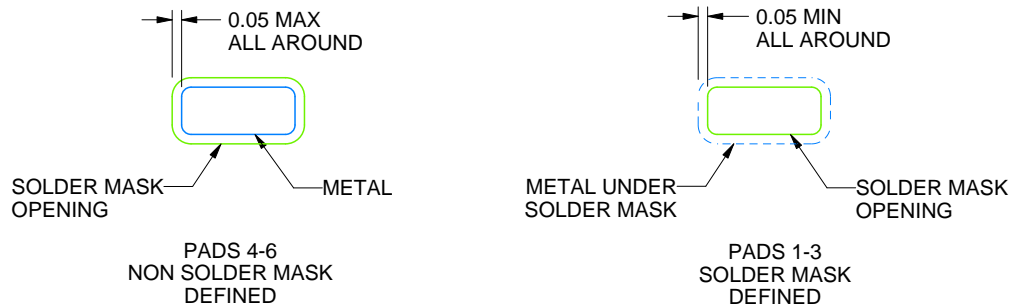

SOLDER MASK DETAILS

4222645/D 05/2022

NOTES: (continued)

3. For more information, see Texas Instruments literature number SLUA271 (www.ti.com/lit/slua271).

EXAMPLE STENCIL DESIGN

DMQ0006A

VSON - 1 mm max height

PLASTIC SMALL OUTLINE - NO LEAD

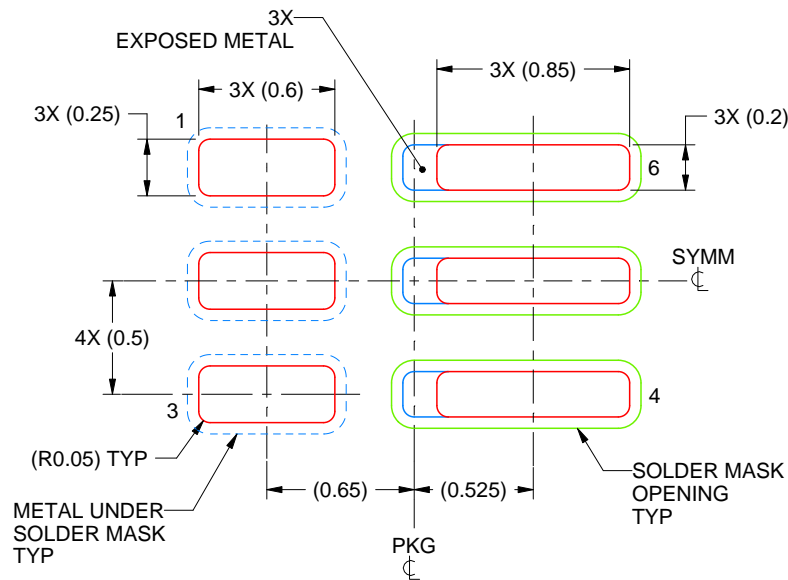

SOLDER PASTE EXAMPLE
BASED ON 0.125 mm THICK STENCIL

PADS 4, 5 & 6:
81% PRINTED SOLDER COVERAGE BY AREA UNDER PACKAGE
SCALE:30X

4222645/D 05/2022

NOTES: (continued)

4. Laser cutting apertures with trapezoidal walls and rounded corners may offer better paste release. IPC-7525 may have alternate design recommendations.

IMPORTANT NOTICE AND DISCLAIMER

TI PROVIDES TECHNICAL AND RELIABILITY DATA (INCLUDING DATA SHEETS), DESIGN RESOURCES (INCLUDING REFERENCE DESIGNS), APPLICATION OR OTHER DESIGN ADVICE, WEB TOOLS, SAFETY INFORMATION, AND OTHER RESOURCES "AS IS" AND WITH ALL FAULTS, AND DISCLAIMS ALL WARRANTIES, EXPRESS AND IMPLIED, INCLUDING WITHOUT LIMITATION ANY IMPLIED WARRANTIES OF MERCHANTABILITY, FITNESS FOR A PARTICULAR PURPOSE OR NON-INFRINGEMENT OF THIRD PARTY INTELLECTUAL PROPERTY RIGHTS.

These resources are intended for skilled developers designing with TI products. You are solely responsible for (1) selecting the appropriate TI products for your application, (2) designing, validating and testing your application, and (3) ensuring your application meets applicable standards, and any other safety, security, regulatory or other requirements.

These resources are subject to change without notice. TI grants you permission to use these resources only for development of an application that uses the TI products described in the resource. Other reproduction and display of these resources is prohibited. No license is granted to any other TI intellectual property right or to any third party intellectual property right. TI disclaims responsibility for, and you will fully indemnify TI and its representatives against, any claims, damages, costs, losses, and liabilities arising out of your use of these resources.

TI's products are provided subject to [TI's Terms of Sale](#) or other applicable terms available either on ti.com or provided in conjunction with such TI products. TI's provision of these resources does not expand or otherwise alter TI's applicable warranties or warranty disclaimers for TI products.

TI objects to and rejects any additional or different terms you may have proposed.

Mailing Address: Texas Instruments, Post Office Box 655303, Dallas, Texas 75265
Copyright © 2022, Texas Instruments Incorporated