



Dual, VARIABLE GAIN AMPLIFIER with Input Buffer

FEATURES

- GAIN RANGE: 40dB
- 40MHz BANDWIDTH
- LOW CROSSTALK: 70dB at Max Gain, 5MHz
- HIGH-SPEED VARIABLE GAIN ADJUST
- POWER SHUTDOWN MODE
- HIGH IMPEDANCE INPUT BUFFER

APPLICATIONS

- ULTRASOUND SYSTEMS
- GAMMA CAMERAS
- WIRELESS RECEIVERS
- TEST EQUIPMENT

DESCRIPTION

The VCA2614 is a highly integrated, dual receive channel, Variable Gain Amplifier (VGA) with analog gain control.

The VCA2614's VGA section consists of two parts: the Voltage Controlled Attenuator (VCA) and the Programmable Gain Amplifier (PGA). The gain and gain range of the PGA can be digitally programmed. The combination of these two programmable elements results in a variable gain ranging from 0dB up to a maximum gain as defined by the user through external connections. The single-ended unity gain input buffer provides predictable high input impedance. The output of the VGA can be used in either a single-ended or differential mode to drive high-performance Analog-to-Digital Converters (ADCs). A separate power-down pin reduces power consumption.

The VCA2614 also features low crosstalk and outstanding distortion performance. The combination of low noise and gain range programmability makes the VCA2614 a versatile building block in a number of applications where noise performance is critical. The VCA2614 is available in a TQFP-32 package.

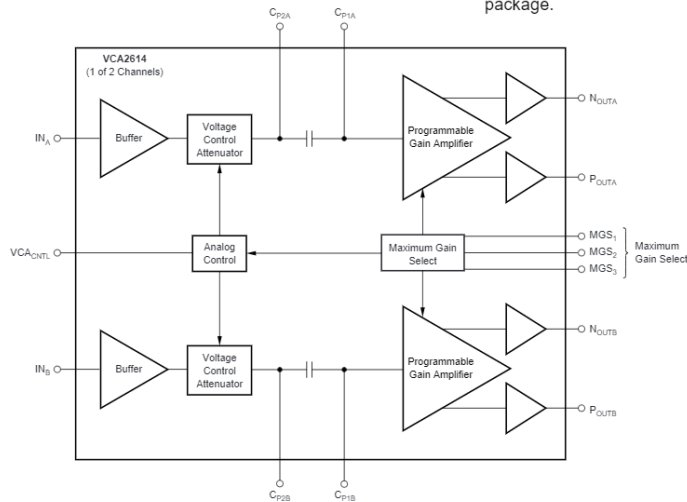

Please be aware that an important notice concerning availability, standard warranty, and use in critical applications of Texas Instruments semiconductor products and disclaimers thereto appears at the end of this data sheet.

PRODUCTION DATA information is current as of publication date. Products conform to specifications per the terms of Texas Instruments standard warranty. Production processing does not necessarily include testing of all parameters.

ABSOLUTE MAXIMUM RATINGS⁽¹⁾

Power Supply (+V _S)	+6V
Analog Input	-0.3V to (+V _S + 0.3V)
Logic Input	-0.3V to (+V _S + 0.3V)
Case Temperature	+100°C
Junction Temperature	+150°C
Storage Temperature	-40°C to +150°C

NOTE: (1) Stresses above those listed under "Absolute Maximum Ratings" may cause permanent damage to the device. Exposure to absolute maximum conditions for extended periods may affect device reliability.



ELECTROSTATIC DISCHARGE SENSITIVITY

This integrated circuit can be damaged by ESD. Texas Instruments recommends that all integrated circuits be handled with appropriate precautions. Failure to observe proper handling and installation procedures can cause damage.

ESD damage can range from subtle performance degradation to complete device failure. Precision integrated circuits may be more susceptible to damage because very small parametric changes could cause the device not to meet its published specifications.

PACKAGE/ORDERING INFORMATION

PRODUCT	PACKAGE-LEAD	PACKAGE DESIGNATOR ⁽¹⁾	SPECIFIED TEMPERATURE RANGE	PACKAGE MARKING	ORDERING NUMBER	TRANSPORT MEDIA, QUANTITY
VCA2614Y	TQFP-32 Surface-Mount	PBS	-40°C to +85°C	VCA2614Y	VCA2614Y/250	Tape and Reel, 250
"	"	"	"	"	VCA2614Y/2K	Tape and Reel, 2000

NOTE: (1) For the most current specifications and package information, refer to our web site at www.ti.com.

ELECTRICAL CHARACTERISTICS

At T_A = +25°C, V_{DD} = 5V, load resistance = 500Ω on each output to ground differential output (2V_{p-p}), MGS = 011, and f_N = 5MHz, unless otherwise noted.

PARAMETER	CONDITIONS	VCA2614Y			UNITS
		MIN	TYP	MAX	
BUFFER					
Input Resistance			600		kΩ
Input Capacitance			5		pF
Input Bias Current			1		nA
Maximum Input Voltage			1		V _{p-p}
Input Voltage Noise	MGS = 111, PGA Gain = 44.2dB, R _S = 50Ω		4.8		nV/√Hz
Input Current Noise	Independent of Gain		350		fA/√Hz
Noise Figure	R _F = 550Ω, PGA Gain = 44.2dB, R _S = 75Ω		13		dB
Bandwidth			100		MHz
PROGRAMMABLE VARIABLE GAIN AMPLIFIER					
Peak Input Voltage			1		V _{p-p}
-3dB Bandwidth			40		MHz
Slew Rate			300		V/μs
Output Signal Range	R _L ≥ 500Ω Each Side to Ground		2.5 ±1		V
Output Impedance	f = 5MHz		1		Ω
Output Short-Circuit Current			±40		mA
3rd-Harmonic Distortion	f = 5MHz, V _{OUT} = 2V _{p-p} , VCA _{CNTL} = 3.0V	-45	-80		dBc
2nd-Harmonic Distortion	f = 5MHz, V _{OUT} = 2V _{p-p} , VCA _{CNTL} = 3.0V	-45	-50		dBc
Overload Performance (2nd-Harmonic Distortion)	Input Signal = 1V _{p-p} , MGS = 111, VCA _{CNTL} = 2V		-40 to -45		dB
Time Delay			5		ns
IMD, 2-Tone	V _{OUT} = 2V _{p-p} , f = 9.95MHz		-59		dBc
Crosstalk			70		dB
Group Delay Variation	1MHz < f < 10MHz, Full Gain Range		13		ns
ACCURACY					
Gain Slope			10.5		dB/V
Gain Error				±2 ⁽¹⁾	dB
Output Offset Voltage			±50		mV
GAIN CONTROL INTERFACE					
Input Voltage (VCA _{CNTL}) Range			0.2 to 3.0		V
Input Resistance			1		MΩ
Response Time	40dB Gain Change, MGS = 111		0.2		μs
POWER SUPPLY					
Specified Operating Range	Operating, Each Channel	4.75	5.0	5.25	V
Power Dissipation			120	150	mW
Power-Down			9.2		mW

NOTE: (1) Referenced to best fit dB-linear curve.

PIN CONFIGURATION

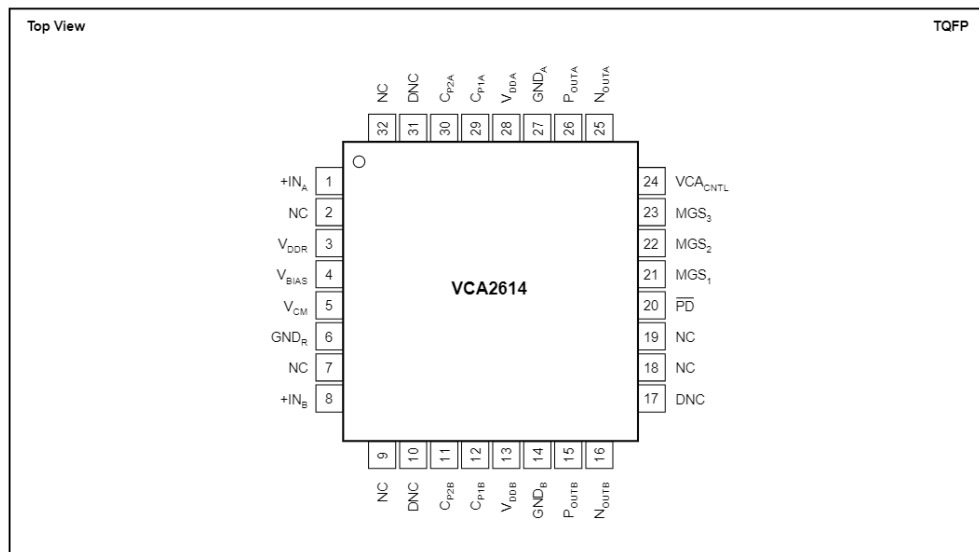

PIN DESCRIPTIONS

PIN	DESIGNATOR	DESCRIPTION	PIN	DESIGNATOR	DESCRIPTION
1	+IN _A	Input Channel A	17	DNC	Do Not Connect
2	NC	No Internal Connection	18	NC	No Internal Connection
3	V _{DDR}	Internal Reference Supply	19	NC	No Internal Connection
4	V _{BIAS}	Bias Voltage	20	$\overline{\text{PD}}$	Power Down (Active LOW)
5	V _{CM}	Common-Mode Voltage	21	MGS ₁	Maximum Gain Select 1 (MSB)
6	GND _R	Internal Reference Ground	22	MGS ₂	Maximum Gain Select 2
7	NC	No Internal Connection	23	MGS ₃	Maximum Gain Select 3 (LSB)
8	+IN _B	Input Channel B	24	VCA _{CTL}	VCA Analog Control
9	NC	No Internal Connection	25	N _{OUTA}	Negative VCA Output Channel A
10	DNC	Do Not Connect	26	P _{OUTA}	Positive VCA Output Channel A
11	C _{P2B}	Coupling Capacitor Channel B	27	GND _A	Ground Channel A
12	C _{P1B}	Coupling Capacitor Channel B	28	V _{DDA}	+5V Supply Channel A
13	V _{DDB}	+5V Supply Channel B	29	C _{P1A}	Coupling Capacitor Channel A
14	GND _B	Ground Channel B	30	C _{P2A}	Coupling Capacitor Channel A
15	P _{OUTB}	Positive Output Channel B	31	DNC	Do Not Connect
16	N _{OUTB}	Negative Output Channel B	32	NC	No Internal Connection

TYPICAL CHARACTERISTICS

At $T_A = +25^\circ\text{C}$, $V_{DD} = 5\text{V}$, load resistance = 500Ω on each output to ground, differential output (2Vp-p) MGS = 011, and $f_{IN} = 5\text{MHz}$, unless otherwise noted.

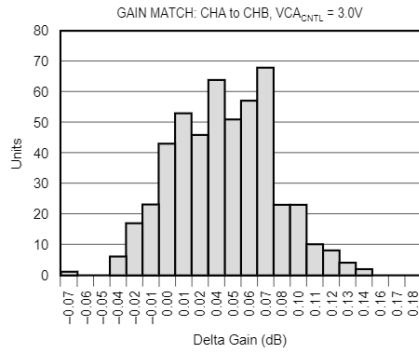
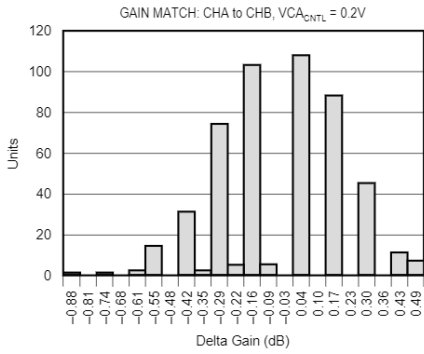
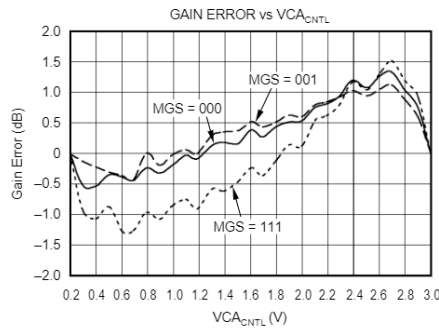
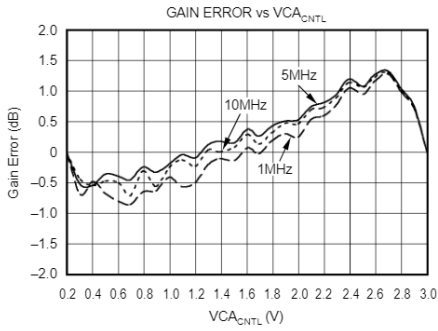
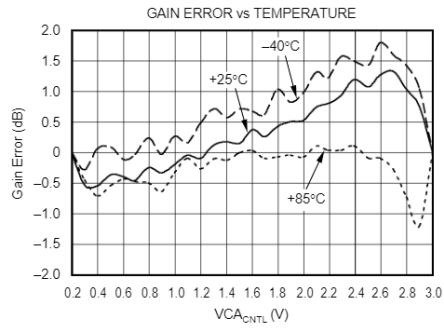
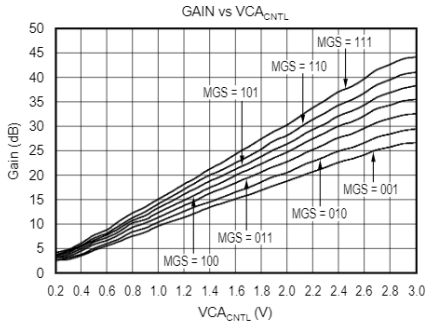

TYPICAL CHARACTERISTICS (Cont.)

At $T_A = +25^\circ\text{C}$, $V_{DD} = 5\text{V}$, load resistance = 500Ω on each output to ground, differential output (2Vp-p) MGS = 011, and $f_{IN} = 5\text{MHz}$, unless otherwise noted.

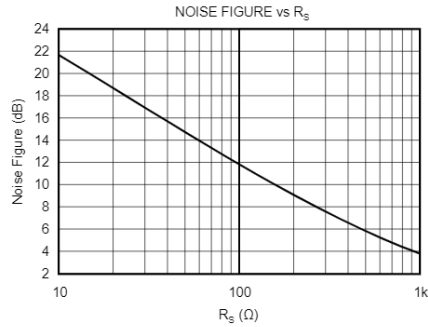
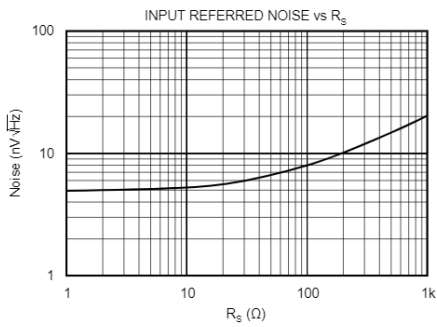
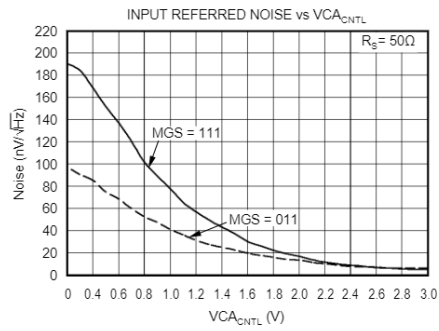
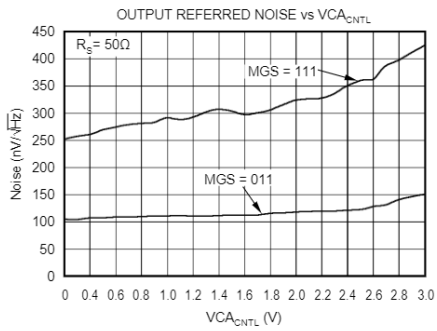
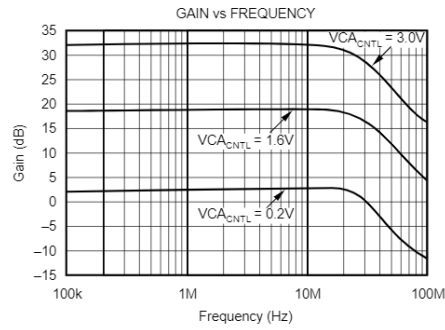
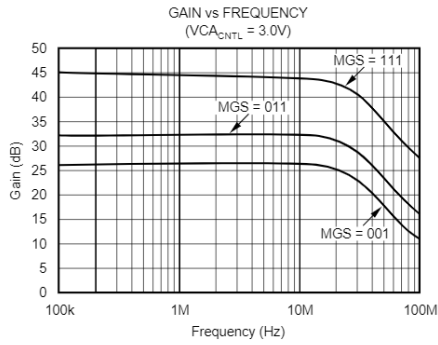

TYPICAL CHARACTERISTICS (Cont.)

At $T_A = +25^\circ\text{C}$, $V_{DD} = 5\text{V}$, load resistance = 500Ω on each output to ground, differential output (2Vp-p) MGS = 011, and $f_{IN} = 5\text{MHz}$, unless otherwise noted.

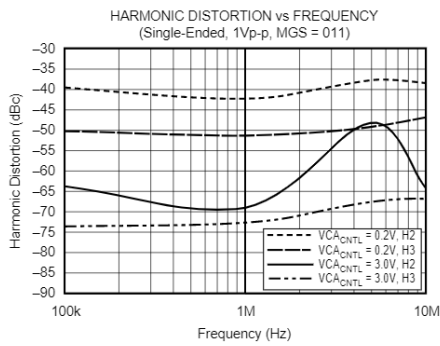
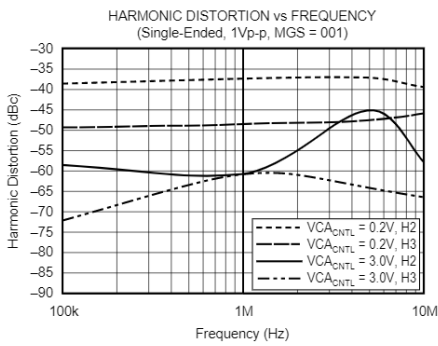
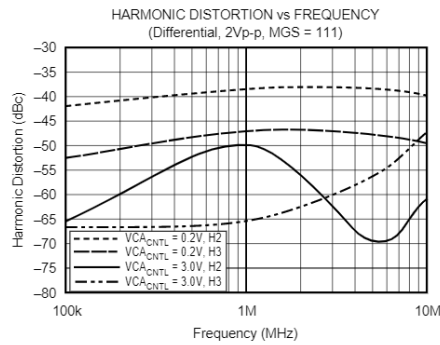
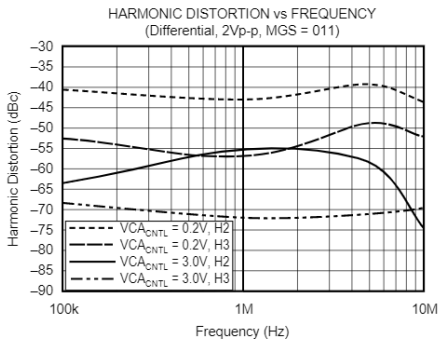
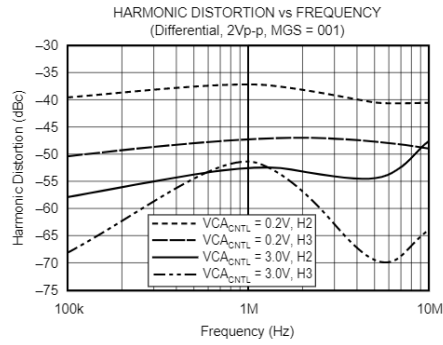
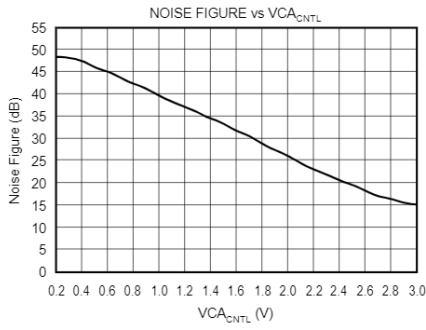

TYPICAL CHARACTERISTICS (Cont.)

At $T_A = +25^\circ\text{C}$, $V_{DD} = 5\text{V}$, load resistance = 500Ω on each output to ground, differential output (2Vp-p) MGS = 011, and $f_{IN} = 5\text{MHz}$, unless otherwise noted.

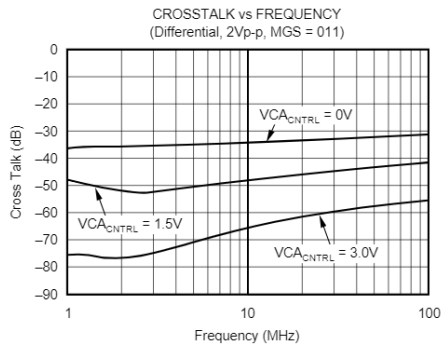
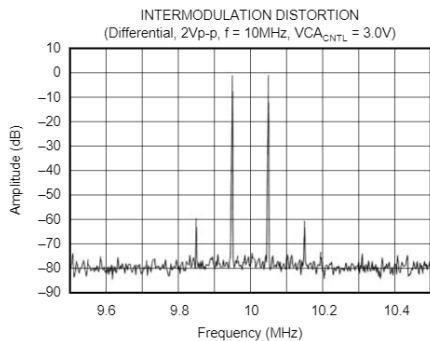
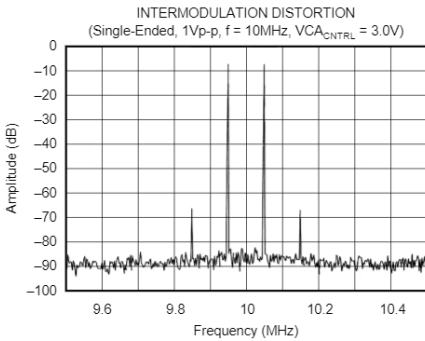
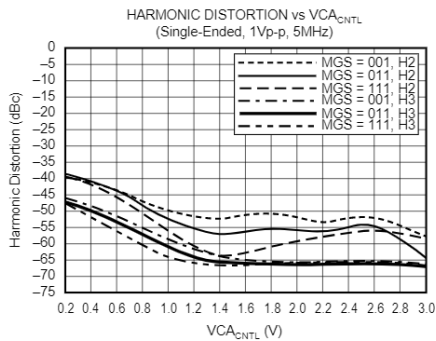
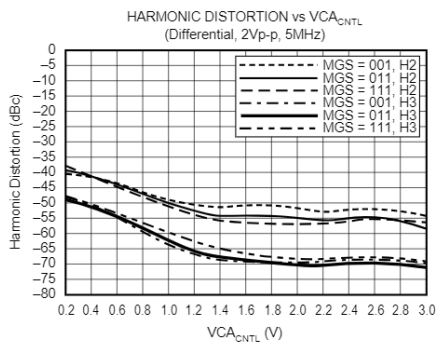
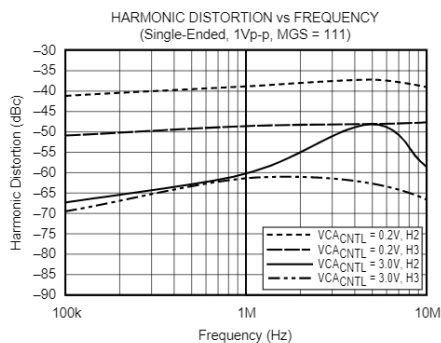

TYPICAL CHARACTERISTICS (Cont.)

At $T_A = +25^\circ\text{C}$, $V_{DD} = 5\text{V}$, load resistance = 500Ω on each output to ground, differential output (2Vp-p) MGS = 011, and $f_{IN} = 5\text{MHz}$, unless otherwise noted.

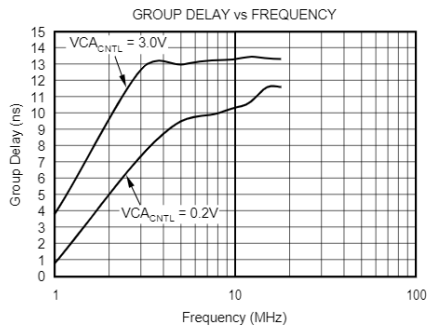
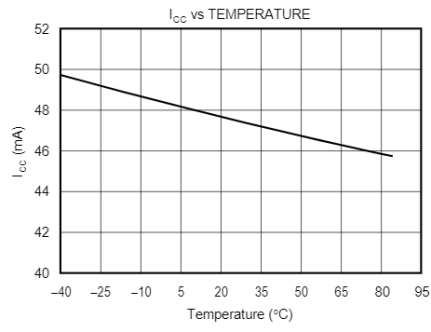
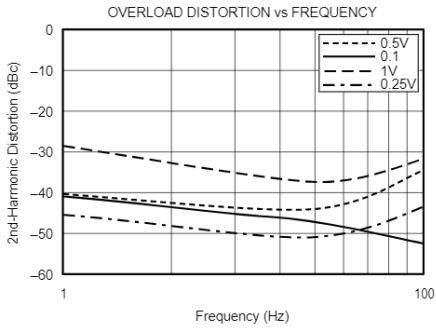

OVERVIEW

The VCA2614 is a dual-channel, VGA consisting of three primary blocks: an Input Buffer, a VCA, and a PGA (as shown in Figure 1). All stages are AC-coupled with the coupling into the PGA stage being made variable by placing an external capacitor between the C_{P1} and C_{P2} pins. This will be discussed further in the PGA section. By using the internal coupling into the PGA, the result is a high-pass filter characteristic with cutoff at approximately 75kHz. The output PGA naturally rolls off at around 40MHz, making the usable bandwidth of the VCA2614 between 75kHz and 40MHz.

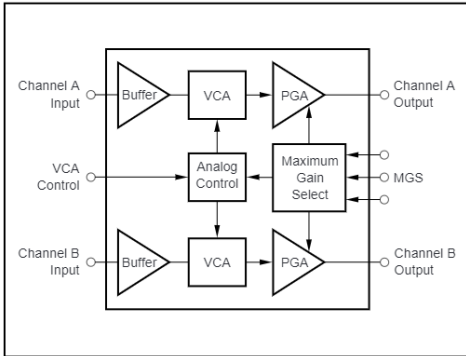

FIGURE 1. Simplified Block Diagram of the VCA2614.

INPUT BUFFER

The input buffer is a unity gain amplifier (gain of +1) with a bandwidth of 100MHz with an input resistance of approximately 600k Ω . The input buffer isolates the circuit driving the VCA2614 inputs from the internal VCA block, which would present a varying impedance to the input circuitry. To allow symmetrical operation of the input buffer, the input to the buffer must be AC-coupled through an external capacitor. The recommended value of the capacitor is 0.01 μ F. It should be noted that if the capacitor value were increased, the

power-on time of the VCA2614 would be increased. If a decrease in the power-on time is needed, the value can be decreased to no less than 100pF.

VOLTAGE-CONTROLLED ATTENUATOR

The magnitude of the VCA input signal from the input buffer is reduced by a programmable attenuation factor, set by the analog VCA Control Voltage (VCA_{CNTL}) at pin 24. The maximum attenuation is programmable by using the three MGS bits (pins 21, 22, and 23). Figure 2 illustrates this dual-adjust characteristic.

The MGS bits adjust the overall range of attenuation and maximum gain while the VCA_{CNTL} voltage adjusts the actual attenuation factor. At any given maximum gain setting, the analog variable gain characteristic is linear in dB as a function of the control voltage, and is created as a piecewise approximation of an ideal dB-linear transfer function, see Figure 4. The VCA control circuitry is common to both channels of the VCA2614. The range for the VCA_{CNTL} input spans from 0V to 3V. Although overdriving the VCA_{CNTL} input above the recommended 3V maximum will not damage the part, this condition should be avoided.

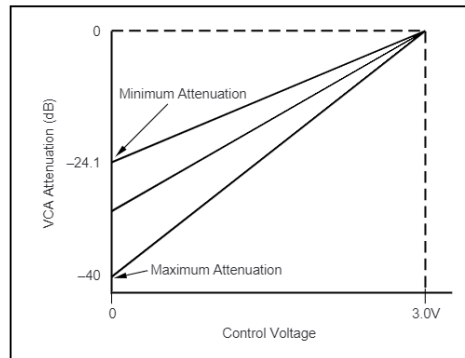

FIGURE 2. Swept Attenuator Characteristic.

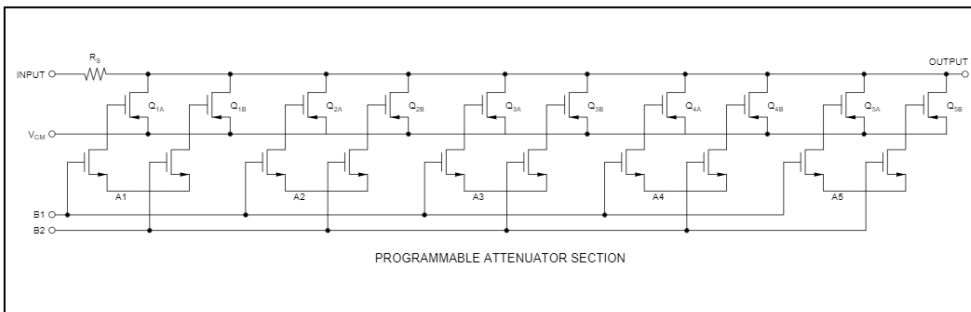

FIGURE 3. Programmable Attenuator Section.

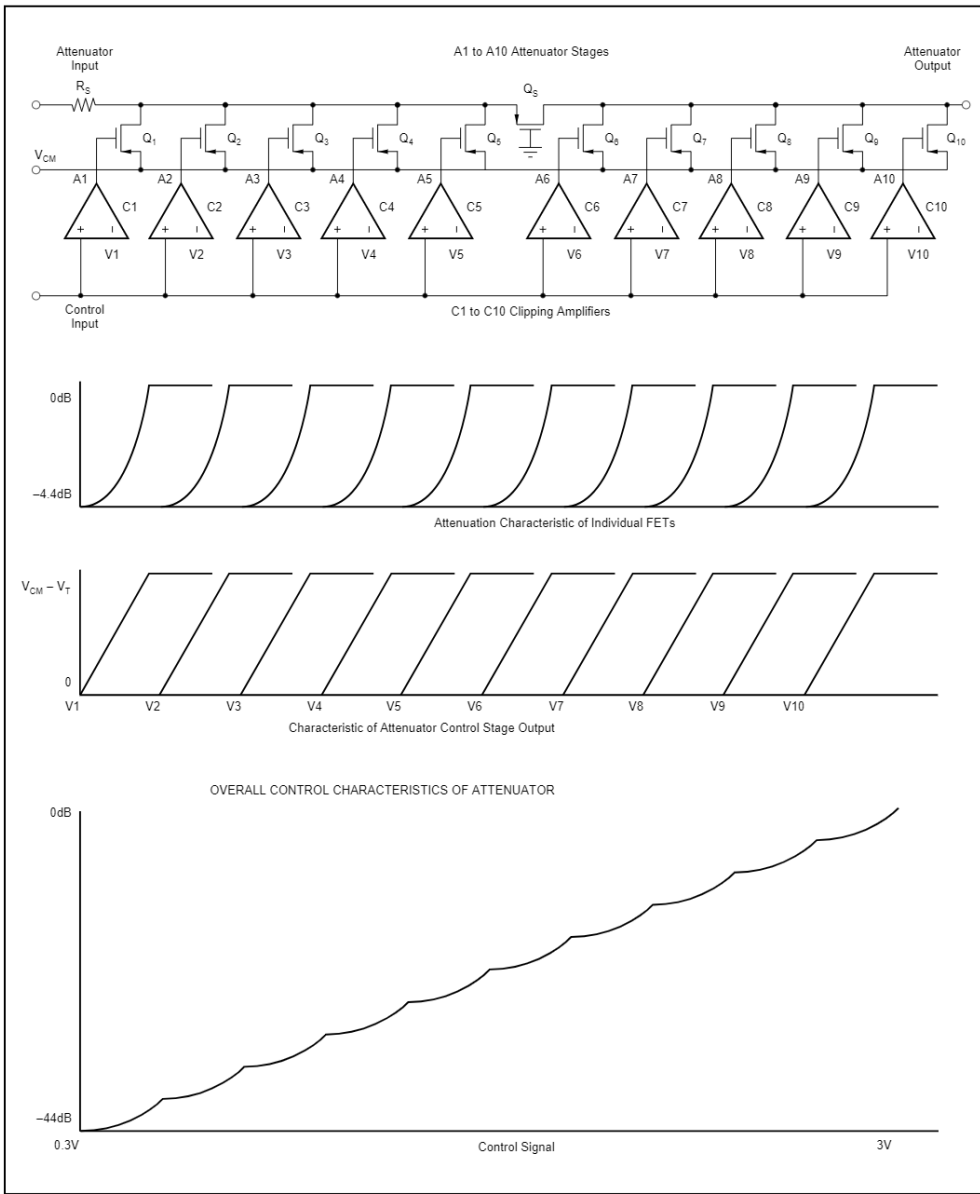

FIGURE 4. Piecewise Approximation to Logarithmic Control Characteristics.

PGA POST-AMPLIFIER

Figure 5 shows a simplified circuit diagram of the PGA block. As stated before, the input to the PGA is AC-coupled by an internal capacitor. Provisions are made so that an external capacitor can be placed in parallel with the internal capacitor, thus lowering the usable low-frequency bandwidth. The low-frequency bandwidth is set by the following equation:

$$\frac{1}{(2 \cdot \pi \cdot 500\text{k}\Omega \cdot (220\text{pF} + C_{\text{EXTERNAL}}))}$$

where C_{EXTERNAL} is the external capacitor value in picofarads. Care should be taken to avoid using too large a value of capacitor, as this can increase the power-on delay time.

As described previously, the PGA gain is programmed with the same MGS bits that control the VCA maximum attenuation factor. Specifically, the maximum PGA gain at each MGS setting is the inverse (reciprocal) of the maximum VCA attenuation at that setting. Therefore, the VCA + PGA overall gain will always be 0dB (unity) when the analog VCA_{CNTL} input is set to 0V (the maximum attenuation for VCA). For $VCA_{\text{CNTL}} = 3\text{V}$ (no attenuation), the VCA + PGA gain will be controlled by the programmed PGA gain. For clarity, the gain and attenuation factors are detailed in Table I.

The PGA architecture converts the single-ended signal from the VCA into a differential signal. Low input noise was also a requirement of the PGA design due to the large amount of signal attenuation that can be asserted before the PGA. At minimum VCA attenuation (used for small input signals), the

MGS SETTING	ATTENUATOR GAIN $VCA_{\text{CNTL}} = 0.02\text{V to } 3\text{V}$	ATTENUATOR + DIFFERENTIAL PGA GAIN
000	Not Valid	Not Valid
001	-24.1dB to 0dB	2.6dB to 26.7dB
010	-26.9dB to 0dB	2.6dB to 29.5dB
011	-29.5dB to 0dB	3.0dB to 35.6dB
100	-32.4dB to 0dB	3.1dB to 35.5dB
101	-34.8dB to 0dB	3.4dB to 38.3dB
110	-37.3dB to 0dB	3.7dB to 44.1dB
111	-40.0dB to 0dB	4.1dB to 44.2dB

TABLE I. MGS Settings.

input buffer noise dominates; at maximum VCA attenuation (large input signals), the PGA noise dominates. Note that if the PGA output is used single-ended, the apparent gain will be 6dB lower.

LAYOUT CONSIDERATIONS

The VCA2614 is an analog amplifier capable of high gain. When working on a PCB layout for the VCA2614, it is recommended to utilize a solid ground plane that is connected to analog ground. This helps to maximize the noise performance of the VCA2614.

Adequate power-supply decoupling must be used in order to achieve the best possible performance. Decoupling capacitors on the VCA_{CNTL} voltage should also be used to help minimize noise. Recommended values can be obtained from the layout diagram of Figure 6.

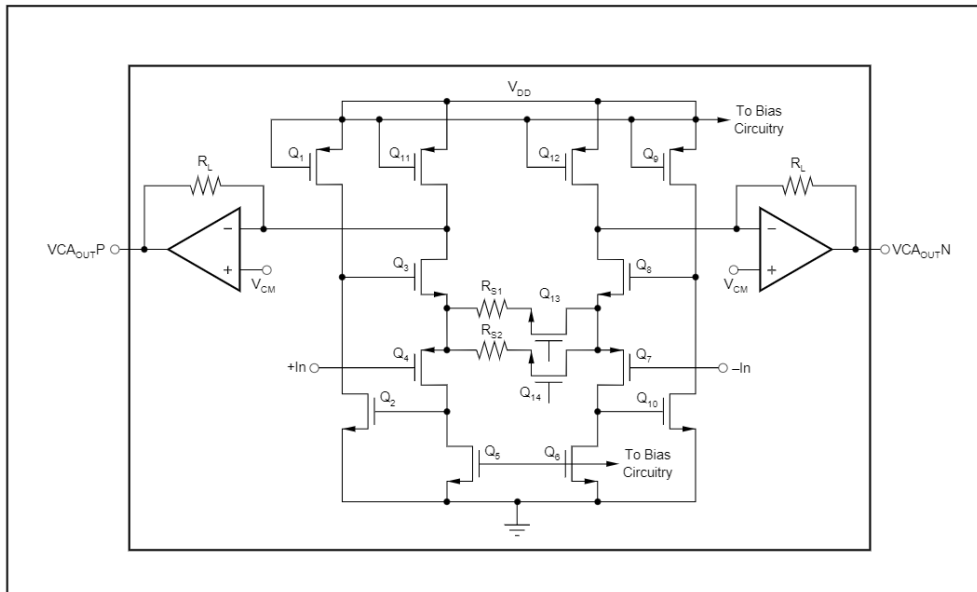

FIGURE 5. Simplified Block Diagram of the PGA Section with the VCA2614.

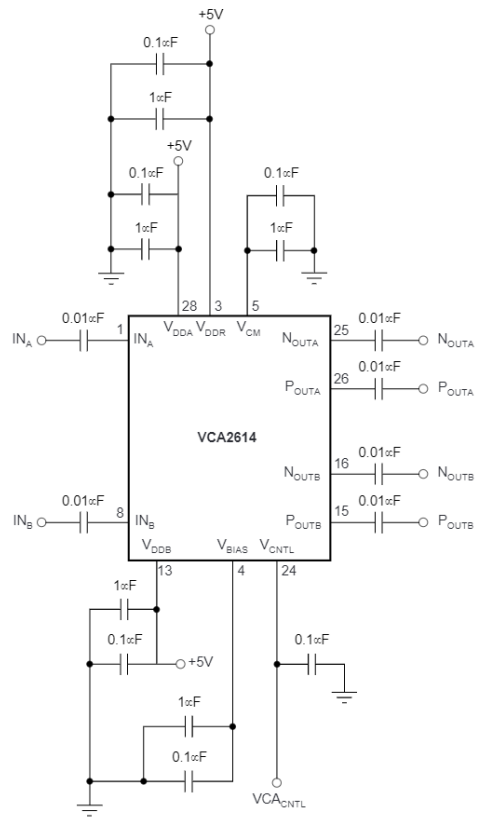

FIGURE 6. VCA2614 Layout.

PACKAGING INFORMATION

Orderable Device	Status (1)	Package Type	Package Drawing	Pins	Package Qty	Eco Plan (2)	Lead/Ball Finish (6)	MSL Peak Temp (3)	Op Temp (°C)	Device Marking (4/5)	Samples
VCA2614Y/250	ACTIVE	TQFP	PBS	32	250	Green (RoHS & no Sb/Br)	CU NIPDAU	Level-3-260C-168 HR	-40 to 85	2614Y	Samples

(1) The marketing status values are defined as follows:

ACTIVE: Product device recommended for new designs.

LIFEBUY: TI has announced that the device will be discontinued, and a lifetime-buy period is in effect.

NRND: Not recommended for new designs. Device is in production to support existing customers, but TI does not recommend using this part in a new design.

PREVIEW: Device has been announced but is not in production. Samples may or may not be available.

OBSOLETE: TI has discontinued the production of the device.

(2) **RoHS:** TI defines "RoHS" to mean semiconductor products that are compliant with the current EU RoHS requirements for all 10 RoHS substances, including the requirement that RoHS substance do not exceed 0.1% by weight in homogeneous materials. Where designed to be soldered at high temperatures, "RoHS" products are suitable for use in specified lead-free processes. TI may reference these types of products as "Pb-Free".

RoHS Exempt: TI defines "RoHS Exempt" to mean products that contain lead but are compliant with EU RoHS pursuant to a specific EU RoHS exemption.

Green: TI defines "Green" to mean the content of Chlorine (Cl) and Bromine (Br) based flame retardants meet JS709B low halogen requirements of <=1000ppm threshold. Antimony trioxide based flame retardants must also meet the <=1000ppm threshold requirement.

(3) MSL, Peak Temp. - The Moisture Sensitivity Level rating according to the JEDEC industry standard classifications, and peak solder temperature.

(4) There may be additional marking, which relates to the logo, the lot trace code information, or the environmental category on the device.

(5) Multiple Device Markings will be inside parentheses. Only one Device Marking contained in parentheses and separated by a "-" will appear on a device. If a line is indented then it is a continuation of the previous line and the two combined represent the entire Device Marking for that device.

(6) Lead/Ball Finish - Orderable Devices may have multiple material finish options. Finish options are separated by a vertical ruled line. Lead/Ball Finish values may wrap to two lines if the finish value exceeds the maximum column width.

Important Information and Disclaimer: The information provided on this page represents TI's knowledge and belief as of the date that it is provided. TI bases its knowledge and belief on information provided by third parties, and makes no representation or warranty as to the accuracy of such information. Efforts are underway to better integrate information from third parties. TI has taken and continues to take reasonable steps to provide representative and accurate information but may not have conducted destructive testing or chemical analysis on incoming materials and chemicals. TI and TI suppliers consider certain information to be proprietary, and thus CAS numbers and other limited information may not be available for release.

In no event shall TI's liability arising out of such information exceed the total purchase price of the TI part(s) at issue in this document sold by TI to Customer on an annual basis.

TAPE AND REEL INFORMATION

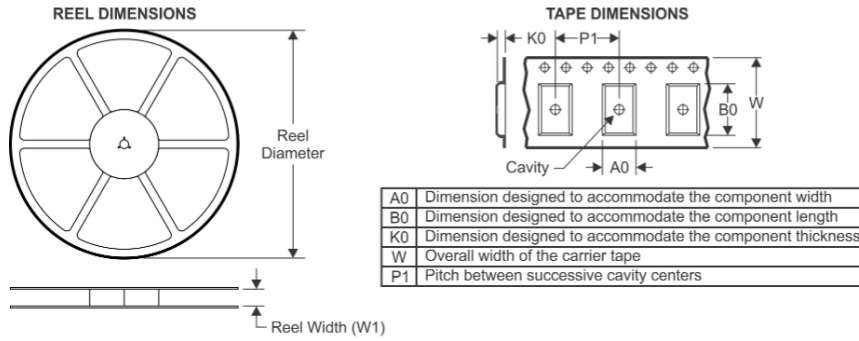

QUADRANT ASSIGNMENTS FOR PIN 1 ORIENTATION IN TAPE

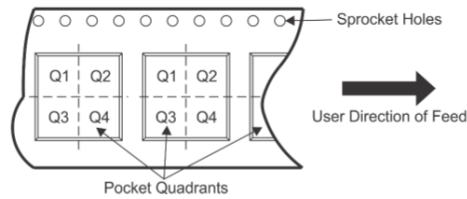

*All dimensions are nominal

Device	Package Type	Package Drawing	Pins	SPQ	Reel Diameter (mm)	Reel Width W1 (mm)	A0 (mm)	B0 (mm)	K0 (mm)	P1 (mm)	W (mm)	Pin1 Quadrant
VCA2614Y/250	TQFP	PBS	32	250	180.0	17.0	7.2	7.2	1.5	12.0	16.0	Q2

TAPE AND REEL BOX DIMENSIONS

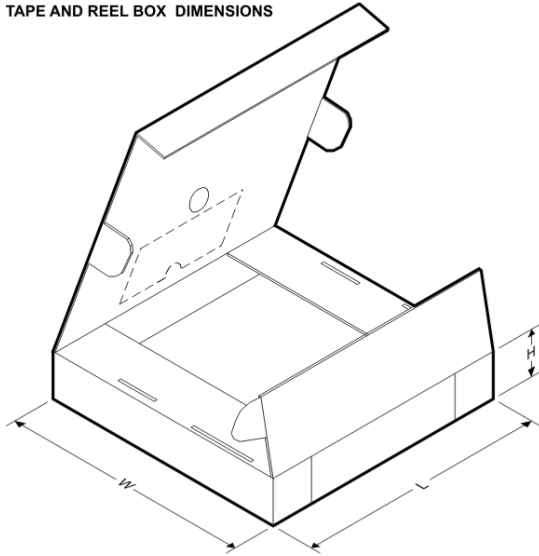

*All dimensions are nominal

Device	Package Type	Package Drawing	Pins	SPQ	Length (mm)	Width (mm)	Height (mm)
VCA2614Y/250	TQFP	PBS	32	250	210.0	185.0	35.0

PBS (S-PQFP-G32)

PLASTIC QUAD FLATPACK

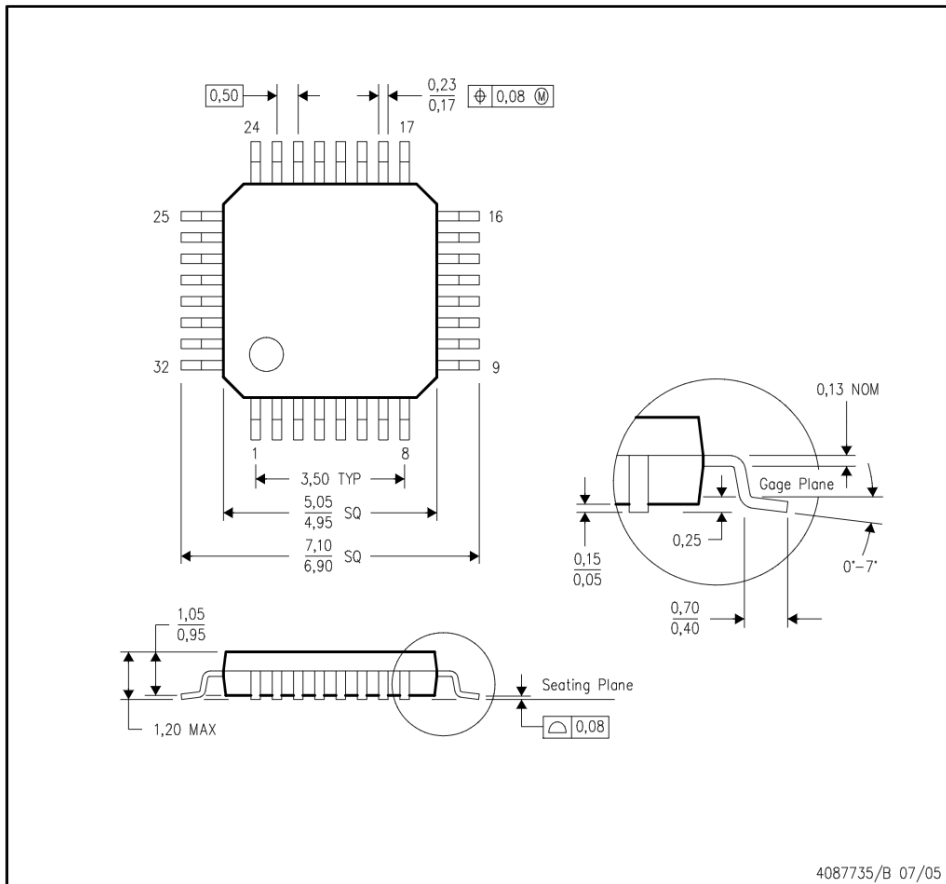

- NOTES:
- A. All linear dimensions are in millimeters.
 - B. This drawing is subject to change without notice.

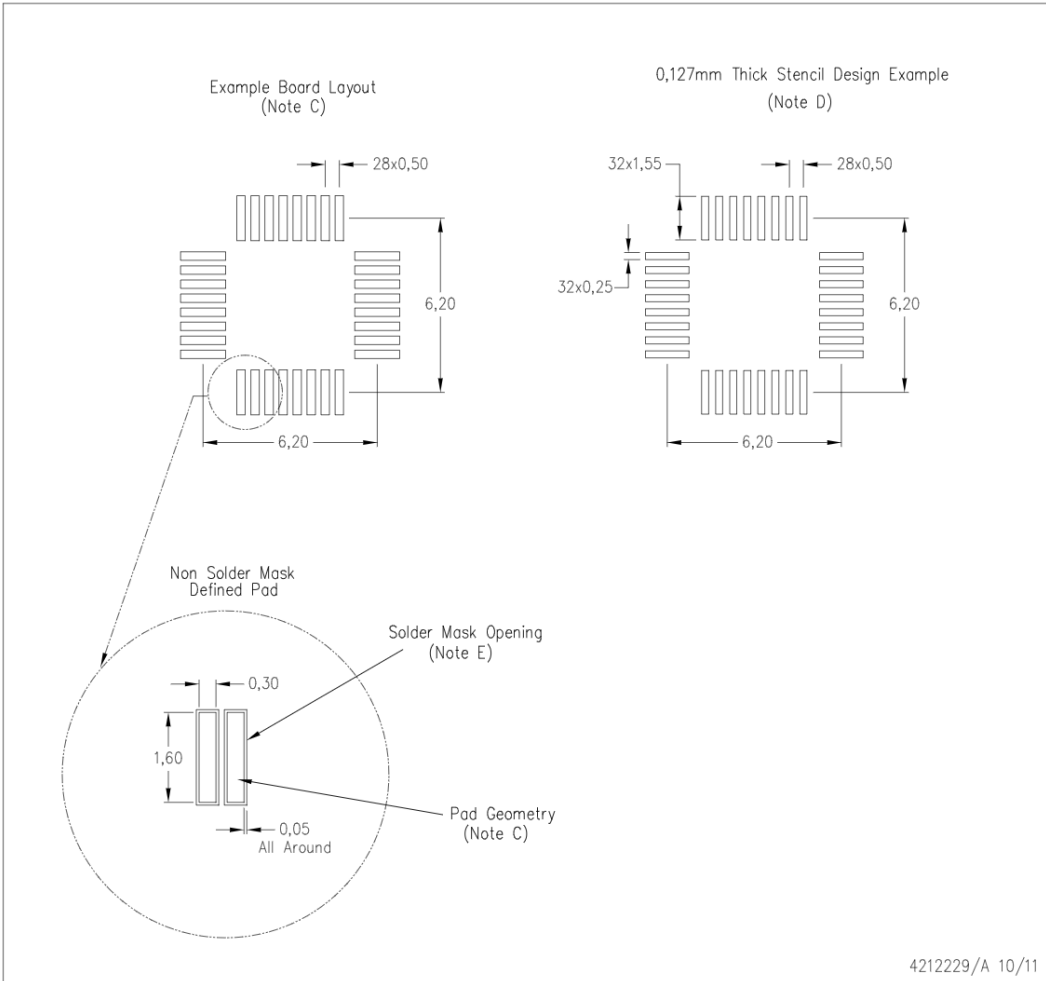

- NOTES:
- A. All linear dimensions are in millimeters.
 - B. This drawing is subject to change without notice.
 - C. Publication IPC-7351 is recommended for alternate designs.
 - D. Laser cutting apertures with trapezoidal walls and also rounding corners will offer better paste release. Customers should contact their board assembly site for stencil design recommendations. Refer to IPC 7525 for stencil design considerations.
 - E. Customers should contact their board fabrication site for recommended solder mask tolerances between and around signal pads.

IMPORTANT NOTICE

Texas Instruments Incorporated (TI) reserves the right to make corrections, enhancements, improvements and other changes to its semiconductor products and services per JESD46, latest issue, and to discontinue any product or service per JESD48, latest issue. Buyers should obtain the latest relevant information before placing orders and should verify that such information is current and complete.

TI's published terms of sale for semiconductor products (<http://www.ti.com/sc/docs/stdterms.htm>) apply to the sale of packaged integrated circuit products that TI has qualified and released to market. Additional terms may apply to the use or sale of other types of TI products and services.

Reproduction of significant portions of TI information in TI data sheets is permissible only if reproduction is without alteration and is accompanied by all associated warranties, conditions, limitations, and notices. TI is not responsible or liable for such reproduced documentation. Information of third parties may be subject to additional restrictions. Resale of TI products or services with statements different from or beyond the parameters stated by TI for that product or service voids all express and any implied warranties for the associated TI product or service and is an unfair and deceptive business practice. TI is not responsible or liable for any such statements.

Buyers and others who are developing systems that incorporate TI products (collectively, "Designers") understand and agree that Designers remain responsible for using their independent analysis, evaluation and judgment in designing their applications and that Designers have full and exclusive responsibility to assure the safety of Designers' applications and compliance of their applications (and of all TI products used in or for Designers' applications) with all applicable regulations, laws and other applicable requirements. Designer represents that, with respect to their applications, Designer has all the necessary expertise to create and implement safeguards that (1) anticipate dangerous consequences of failures, (2) monitor failures and their consequences, and (3) lessen the likelihood of failures that might cause harm and take appropriate actions. Designer agrees that prior to using or distributing any applications that include TI products, Designer will thoroughly test such applications and the functionality of such TI products as used in such applications.

TI's provision of technical, application or other design advice, quality characterization, reliability data or other services or information, including, but not limited to, reference designs and materials relating to evaluation modules, (collectively, "TI Resources") are intended to assist designers who are developing applications that incorporate TI products; by downloading, accessing or using TI Resources in any way, Designer (individually or, if Designer is acting on behalf of a company, Designer's company) agrees to use any particular TI Resource solely for this purpose and subject to the terms of this Notice.

TI's provision of TI Resources does not expand or otherwise alter TI's applicable published warranties or warranty disclaimers for TI products, and no additional obligations or liabilities arise from TI providing such TI Resources. TI reserves the right to make corrections, enhancements, improvements and other changes to its TI Resources. TI has not conducted any testing other than that specifically described in the published documentation for a particular TI Resource.

Designer is authorized to use, copy and modify any individual TI Resource only in connection with the development of applications that include the TI product(s) identified in such TI Resource. NO OTHER LICENSE, EXPRESS OR IMPLIED, BY ESTOPPEL OR OTHERWISE TO ANY OTHER TI INTELLECTUAL PROPERTY RIGHT, AND NO LICENSE TO ANY TECHNOLOGY OR INTELLECTUAL PROPERTY RIGHT OF TI OR ANY THIRD PARTY IS GRANTED HEREIN, including but not limited to any patent right, copyright, mask work right, or other intellectual property right relating to any combination, machine, or process in which TI products or services are used. Information regarding or referencing third-party products or services does not constitute a license to use such products or services, or a warranty or endorsement thereof. Use of TI Resources may require a license from a third party under the patents or other intellectual property of the third party, or a license from TI under the patents or other intellectual property of TI.

TI RESOURCES ARE PROVIDED "AS IS" AND WITH ALL FAULTS. TI DISCLAIMS ALL OTHER WARRANTIES OR REPRESENTATIONS, EXPRESS OR IMPLIED, REGARDING RESOURCES OR USE THEREOF, INCLUDING BUT NOT LIMITED TO ACCURACY OR COMPLETENESS, TITLE, ANY EPIDEMIC FAILURE WARRANTY AND ANY IMPLIED WARRANTIES OF MERCHANTABILITY, FITNESS FOR A PARTICULAR PURPOSE, AND NON-INFRINGEMENT OF ANY THIRD PARTY INTELLECTUAL PROPERTY RIGHTS. TI SHALL NOT BE LIABLE FOR AND SHALL NOT DEFEND OR INDEMNIFY DESIGNER AGAINST ANY CLAIM, INCLUDING BUT NOT LIMITED TO ANY INFRINGEMENT CLAIM THAT RELATES TO OR IS BASED ON ANY COMBINATION OF PRODUCTS EVEN IF DESCRIBED IN TI RESOURCES OR OTHERWISE. IN NO EVENT SHALL TI BE LIABLE FOR ANY ACTUAL, DIRECT, SPECIAL, COLLATERAL, INDIRECT, PUNITIVE, INCIDENTAL, CONSEQUENTIAL OR EXEMPLARY DAMAGES IN CONNECTION WITH OR ARISING OUT OF TI RESOURCES OR USE THEREOF, AND REGARDLESS OF WHETHER TI HAS BEEN ADVISED OF THE POSSIBILITY OF SUCH DAMAGES.

Unless TI has explicitly designated an individual product as meeting the requirements of a particular industry standard (e.g., ISO/TS 16949 and ISO 26262), TI is not responsible for any failure to meet such industry standard requirements.

Where TI specifically promotes products as facilitating functional safety or as compliant with industry functional safety standards, such products are intended to help enable customers to design and create their own applications that meet applicable functional safety standards and requirements. Using products in an application does not by itself establish any safety features in the application. Designers must ensure compliance with safety-related requirements and standards applicable to their applications. Designer may not use any TI products in life-critical medical equipment unless authorized officers of the parties have executed a special contract specifically governing such use. Life-critical medical equipment is medical equipment where failure of such equipment would cause serious bodily injury or death (e.g., life support, pacemakers, defibrillators, heart pumps, neurostimulators, and implantables). Such equipment includes, without limitation, all medical devices identified by the U.S. Food and Drug Administration as Class III devices and equivalent classifications outside the U.S.

TI may expressly designate certain products as completing a particular qualification (e.g., Q100, Military Grade, or Enhanced Product). Designers agree that it has the necessary expertise to select the product with the appropriate qualification designation for their applications and that proper product selection is at Designers' own risk. Designers are solely responsible for compliance with all legal and regulatory requirements in connection with such selection.

Designer will fully indemnify TI and its representatives against any damages, costs, losses, and/or liabilities arising out of Designer's non-compliance with the terms and provisions of this Notice.