

# TLV8801/TLV8802 320 nA Nanopower Operational Amplifiers for Cost-Optimized Systems

## 1 Features

- For Cost-Optimized Systems
- Nanopower Supply Current: 320 nA/channel
- Offset Voltage: 4.5 mV (max)
- Good TcVos: 1  $\mu\text{V}/^\circ\text{C}$
- Unity Gain-Bandwidth: 6 kHz
- Unity-Gain Stable
- Low Input Bias Current : 0.1pA
- Wide Supply Range: 1.7 V to 5.5 V
- Rail-to-Rail Output
- No Output Reversals
- EMI Protection
- Temperature Range:  $-40^\circ\text{C}$  to  $125^\circ\text{C}$
- Industry Standard Packages:
  - Single in 5-pin SOT-23
  - Dual in 8-pin VSSOP

## 2 Applications

- Gas Detectors such as CO detectors and  $\text{O}_2$  detectors
- Motion Detectors Using PIR Sensors
- Ionization Smoke Alarms
- Thermostats
- Remote Sensors, IoT (Internet of Things)
- Active RFID Readers and Tags
- Portable Medical Equipment
- Portable Glucose Monitors

## 3 Description

The TLV8801 (single) and TLV8802 (dual) family of ultra-low-power operational amplifiers are ideal for cost-optimized sensing applications in wireless and low power wired equipment. The TLV880x amplifiers minimize power consumption in equipment such as CO detectors, smoke detectors and motion detecting security systems (like PIR motion sensing) where operational battery-life is critical. They also have a carefully designed CMOS input stage enabling very low, femto-amp bias currents, thereby reducing  $I_{\text{BIAS}}$  and  $I_{\text{OS}}$  errors that would otherwise impact sensitive applications like transimpedance amplifier (TIA) configurations with megaohm feedback resistors, and high source impedance sensing applications. Additionally, built-in EMI protection reduces sensitivity to unwanted RF signals from sources like mobile phones, WiFi, radio transmitters and tag readers.

The TLV8801 (single) and TLV8802 (dual) channel versions are available in industry standard 5-pin SOT-23 and 8-pin VSSOP packages respectively.

### LPV80x and TLV880x Nanopower Amplifiers

PART NUMBER	CHANNELS	SUPPLY CURRENT (Typ/Ch)	OFFSET VOLTAGE (Max)
TLV8801	1	450 nA	4.5 mV
TLV8802	2	320 nA	4.5 mV
LPV801	1	450 nA	3.5 mV
LPV802	2	320 nA	3.5 mV

### Device Information<sup>(1)</sup>

PART NUMBER	PACKAGE	BODY SIZE
TLV8801	SOT-23 (5)	2.90 mm x 1.60 mm
TLV8802	VSSOP (8)	3.00 mm x 3.00 mm

(1) For all available packages, see the orderable addendum at the end of the data sheet.

### Nanopower Electrochemical Sensor Amplifier

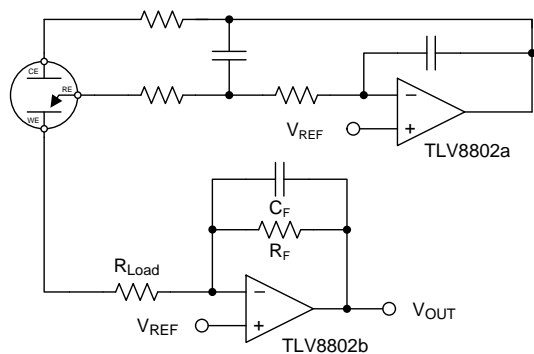

### Nanopower PIR Motion Sensor Amplifier

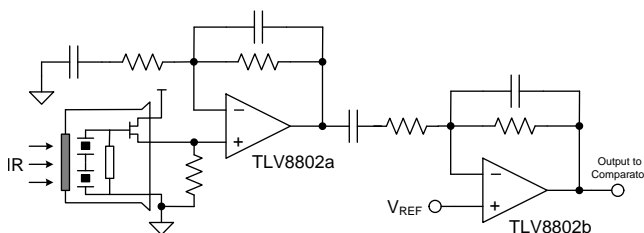

## Table of Contents

<b>1 Features</b> .....	<b>1</b>	8.1 Application Information.....	<b>14</b>
<b>2 Applications</b> .....	<b>1</b>	8.2 Typical Application: Three Terminal CO Gas Sensor Amplifier .....	<b>14</b>
<b>3 Description</b> .....	<b>1</b>	8.3 Do's and Don'ts .....	<b>17</b>
<b>4 Revision History</b> .....	<b>2</b>	<b>9 Power Supply Recommendations</b> .....	<b>17</b>
<b>5 Pin Configuration and Functions</b> .....	<b>3</b>	<b>10 Layout</b> .....	<b>17</b>
<b>6 Specifications</b> .....	<b>4</b>	10.1 Layout Guidelines .....	<b>17</b>
6.1 Absolute Maximum Ratings .....	<b>4</b>	10.2 Layout Example .....	<b>17</b>
6.2 ESD Ratings.....	<b>4</b>	<b>11 Device and Documentation Support</b> .....	<b>18</b>
6.3 Recommended Operating Conditions.....	<b>4</b>	11.1 Device Support .....	<b>18</b>
6.4 Thermal Information .....	<b>4</b>	11.2 Related Links .....	<b>18</b>
6.5 Electrical Characteristics.....	<b>4</b>	11.3 Receiving Notification of Documentation Updates .....	<b>18</b>
6.6 Typical Characteristics.....	<b>6</b>	11.4 Community Resources.....	<b>18</b>
<b>7 Detailed Description</b> .....	<b>12</b>	11.5 Trademarks .....	<b>18</b>
7.1 Overview .....	<b>12</b>	11.6 Electrostatic Discharge Caution.....	<b>18</b>
7.2 Functional Block Diagram .....	<b>12</b>	11.7 Glossary .....	<b>18</b>
7.3 Feature Description.....	<b>12</b>	<b>12 Mechanical, Packaging, and Orderable Information</b> .....	<b>19</b>
7.4 Device Functional Modes.....	<b>12</b>		
<b>8 Application and Implementation</b> .....	<b>14</b>		

## 4 Revision History

<b>Changes from Original (August 2016) to Revision A</b>	<b>Page</b>
• Changed LPV and TLV Nanopower Amplifier table title and updated '01 supply currents .....	<b>1</b>
• Added separate CMRR row for TLV8801 .....	<b>5</b>
• Changed TLV8801 Typical supply current from 500nA to 450nA .....	<b>5</b>

## 5 Pin Configuration and Functions

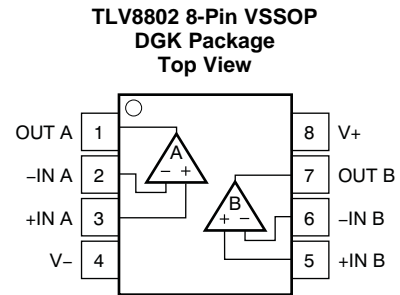
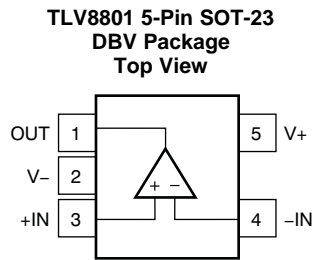

**Pin Functions: TLV8801 DBV**

PIN		I/O	DESCRIPTION
NAME	NUMBER		
OUT	1	O	Output
-IN	4	I	Inverting Input
+IN	3	I	Non-Inverting Input
V-	2	P	Negative (lowest) power supply
V+	5	P	Positive (highest) power supply

**Pin Functions: TLV8802 DGK**

PIN		I/O	DESCRIPTION
NAME	NUMBER		
OUT A	1	O	Channel A Output
-IN A	2	I	Channel A Inverting Input
+IN A	3	I	Channel A Non-Inverting Input
V-	4	P	Negative (lowest) power supply
+IN B	5	I	Channel B Non-Inverting Input
-IN B	6	I	Channel B Inverting Input
OUT B	7	O	Channel B Output
V+	8	P	Positive (highest) power supply

## 6 Specifications

### 6.1 Absolute Maximum Ratings

Over operating free-air temperature range (unless otherwise noted) <sup>(1)</sup>

		MIN	MAX	UNIT
Supply voltage, $V_S = (V+) - (V-)$		-0.3	6	V
Input pins	Voltage <sup>(2) (3)</sup>	Common mode		(V-) - 0.3 (V+) + 0.3
		Differential		(V-) - 0.3 (V+) + 0.3
Input pins	Current	-10	10	mA
Output short current <sup>(4)</sup>		Continuous	Continuous	
Storage temperature, $T_{stg}$		-65	150	°C
Junction temperature			150	°C

- (1) Stresses beyond those listed under *Absolute Maximum Ratings* may cause permanent damage to the device. These are stress ratings only, which do not imply functional operation of the device at these or any other conditions beyond those indicated under *Recommended Operating Conditions*. Exposure to absolute-maximum-rated conditions for extended periods may affect device reliability.
- (2) Not to exceed -0.3V or +6.0V on ANY pin, referred to V-
- (3) Input terminals are diode-clamped to the power-supply rails. Input signals that can swing more than 0.3 V beyond the supply rails should be current-limited to 10 mA or less.
- (4) Short-circuit to  $V_S/2$ , one amplifier per package. Continuous short circuit operation at elevated ambient temperature can result in exceeding the maximum allowed junction temperature of 150°C.

### 6.2 ESD Ratings

		VALUE	UNIT
$V_{(ESD)}$ Electrostatic discharge	Human-body model (HBM), per ANSI/ESDA/JEDEC JS-001 <sup>(1)</sup>	±1000	V
	Charged-device model (CDM), per JEDEC specification JESD22-C101 <sup>(2)</sup>	±250	

- (1) JEDEC document JEP155 states that 500-V HBM allows safe manufacturing with a standard ESD control process. Manufacturing with less than 500-V HBM is possible with the necessary precautions. Pins listed as ±2000 V may actually have higher performance.
- (2) JEDEC document JEP157 states that 250-V CDM allows safe manufacturing with a standard ESD control process. Manufacturing with less than 250-V CDM is possible with the necessary precautions. Pins listed as ±750 V may actually have higher performance.

### 6.3 Recommended Operating Conditions

over operating free-air temperature range (unless otherwise noted)

	MIN	NOM	MAX	UNIT
Supply voltage (V+ – V-)	1.7		5.5	V
Specified temperature	-40		125	°C

### 6.4 Thermal Information

THERMAL METRIC <sup>(1)</sup>		TLV8801 DBV 5 PINS	TLV8802 DGK 8 PINS	UNIT
$\theta_{JA}$	Junction-to-ambient thermal resistance	177.4	177.6	°C/W
$\theta_{JcTop}$	Junction-to-case (top) thermal resistance	133.9	68.8	
$\theta_{JB}$	Junction-to-board thermal resistance	36.3	98.2	
$\psi_{JT}$	Junction-to-top characterization parameter	23.6	12.3	
$\psi_{JB}$	Junction-to-board characterization parameter	35.7	96.7	

- (1) For more information about traditional and new thermal metrics, see the [Semiconductor and IC Package Thermal Metrics](#) application report.

### 6.5 Electrical Characteristics

$T_A = 25^\circ\text{C}$ ,  $V_S = 1.8\text{V}$  to  $5\text{V}$ ,  $V_{CM} = V_{OUT} = V_S/2$ , and  $R_L \geq 10\text{M}\Omega$  to  $V_S/2$ , unless otherwise noted.

PARAMETER	TEST CONDITIONS	MIN	TYP	MAX	UNIT
<b>OFFSET VOLTAGE</b>					

**Electrical Characteristics (continued)**
 $T_A = 25^\circ\text{C}$ ,  $V_S = 1.8\text{V to } 5\text{V}$ ,  $V_{CM} = V_{OUT} = V_S/2$ , and  $R_L \geq 10\text{M}\Omega$  to  $V_S/2$ , unless otherwise noted.

PARAMETER		TEST CONDITIONS	MIN	TYP	MAX	UNIT
$V_{OS}$	Input offset voltage	$V_S = 1.8\text{V}, 3.3\text{V}, \text{ and } 5\text{V}$ , $V_{CM} = V^-$		0.55	$\pm 4.5$	mV
		$V_S = 1.8\text{V}, 3.3\text{V}, \text{ and } 5\text{V}$ , $V_{CM} = (V^+) - 0.9\text{V}$		0.55	$\pm 4.5$	
$\Delta V_{OS}/\Delta T$	Input offset drift	$V_{CM} = V^-$	$T_A = -40^\circ\text{C to } 125^\circ\text{C}$		1	$\mu\text{V}/^\circ\text{C}$
PSRR	Power-supply rejection ratio	$V_S = 1.8\text{V to } 5\text{V}$ , $V_{CM} = V^-$		1.6	60	$\mu\text{V}/\text{V}$
<b>INPUT VOLTAGE RANGE</b>						
$V_{CM}$	Common-mode voltage range	$V_S = 5\text{V}$	0		4.1	V
CMRR	Common-mode rejection ratio, TLV8801	$(V^-) \leq V_{CM} \leq (V^+) - 0.9\text{V}$ , $V_S = 5\text{V}$	77	87		dB
	Common-mode rejection ratio, TLV8802	$(V^-) \leq V_{CM} \leq (V^+) - 0.9\text{V}$ , $V_S = 5\text{V}$	80	90		dB
<b>INPUT BIAS CURRENT</b>						
$I_B$	Input bias current	$V_S = 1.8\text{V}$		$\pm 100$		fA
$I_{OS}$	Input offset current	$V_S = 1.8\text{V}$		$\pm 100$		
<b>INPUT IMPEDANCE</b>						
	Differential			7		pF
	Common mode			3		
<b>NOISE</b>						
$E_n$	Input voltage noise	$f = 0.1\text{ Hz to } 10\text{ Hz}$		12		$\mu\text{Vp-p}$
$e_n$	Input voltage noise density	$f = 100\text{ Hz}$		340		$\text{nV}/\sqrt{\text{Hz}}$
		$f = 1\text{ kHz}$		450		
<b>OPEN-LOOP GAIN</b>						
$A_{OL}$	Open-loop voltage gain	$(V^-) + 0.3\text{V} \leq V_O \leq (V^+) - 0.3\text{V}$ , $R_L = 100\text{ k}\Omega$		120		dB
<b>OUTPUT</b>						
$V_{OH}$	Voltage output swing from positive rail	$V_S = 1.8\text{V}$ , $R_L = 100\text{ k}\Omega$ to $V^+/2$	10	3.5		mV
$V_{OL}$	Voltage output swing from negative rail	$V_S = 1.8\text{V}$ , $R_L = 100\text{ k}\Omega$ to $V^+/2$		2.5	10	
$I_{SC}$	Short-circuit current	$V_S = 3.3\text{V}$ , Short to $V_S/2$		4.7		mA
$Z_O$	Open loop output impedance	$f = 1\text{ kHz}$ , $I_O = 0\text{ A}$		90		k $\Omega$
<b>FREQUENCY RESPONSE</b>						
GBP	Gain-bandwidth product	$C_L = 20\text{ pF}$ , $R_L = 10\text{ M}\Omega$ , $V_S = 5\text{V}$		6		kHz
SR	Slew rate (10% to 90%)	$G = 1$ , Rising Edge, $C_L = 20\text{ pF}$ , $V_S = 5\text{V}$		1.4		V/ms
		$G = 1$ , Falling Edge, $C_L = 20\text{ pF}$ , $V_S = 5\text{V}$		1.5		
<b>POWER SUPPLY</b>						
$I_{Q-TLV8801}$	Quiescent Current	$V_{CM} = V^-$ , $I_O = 0$ , $V_S = 3.3\text{V}$		450	700	nA
$I_{Q-TLV8802}$	Quiescent Current, Per Channel	$V_{CM} = V^-$ , $I_O = 0$ , $V_S = 3.3\text{V}$		320	650	nA

## 6.6 Typical Characteristics

at  $T_A = 25^\circ\text{C}$ ,  $R_L = 10\text{M}\Omega$  to  $V_S/2$ ,  $C_L = 20\text{pF}$ ,  $V_{CM} = V_S / 2\text{V}$  unless otherwise specified.

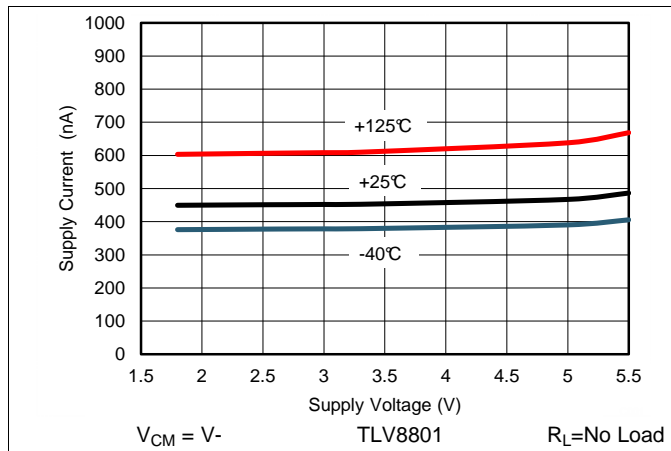

Figure 1. Supply Current vs. Supply Voltage, TLV8801

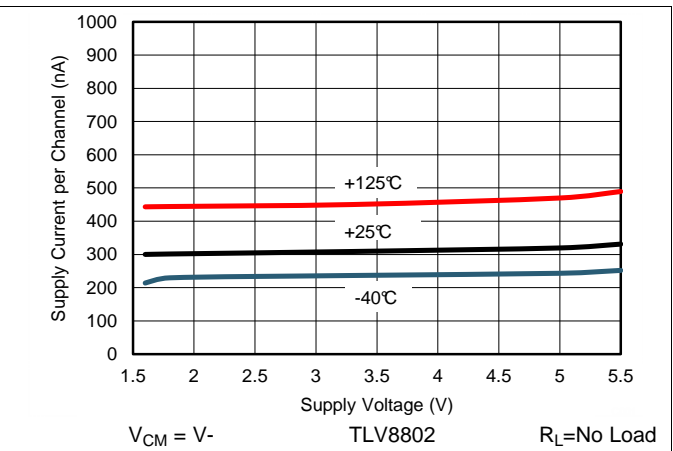

Figure 2. Supply Current vs. Supply Voltage, TLV8802



Figure 3. Typical Offset Voltage vs. Common Mode Voltage



Figure 4. Typical Offset Voltage vs. Common Mode Voltage



Figure 5. Typical Offset Voltage vs. Common Mode Voltage



Figure 6. Input Bias Current vs. Temperature

**Typical Characteristics (continued)**

at  $T_A = 25^\circ\text{C}$ ,  $R_L = 10\text{M}\Omega$  to  $V_S/2$ ,  $C_L = 20\text{pF}$ ,  $V_{CM} = V_S / 2\text{V}$  unless otherwise specified.

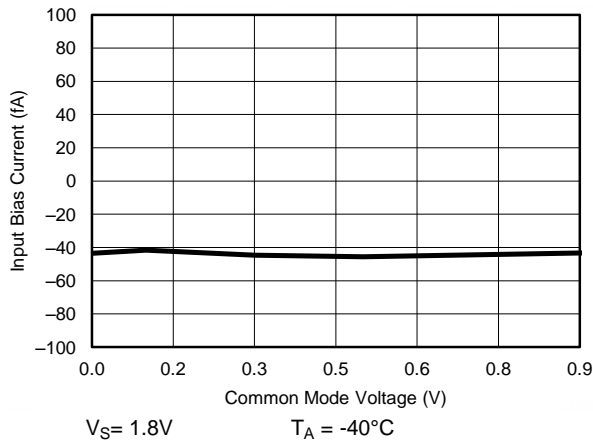

**Figure 7. Input Bias Current vs. Common Mode Voltage**

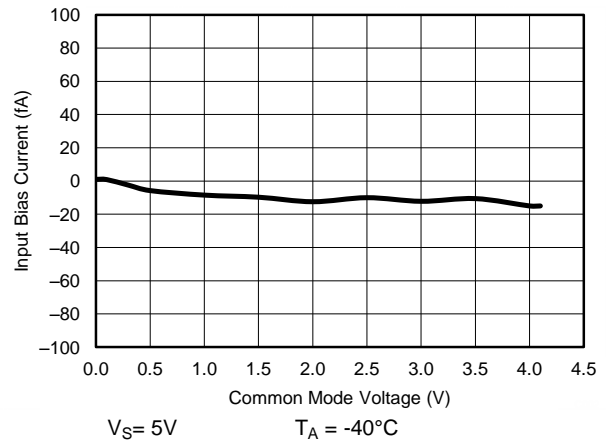

**Figure 8. Input Bias Current vs. Common Mode Voltage**

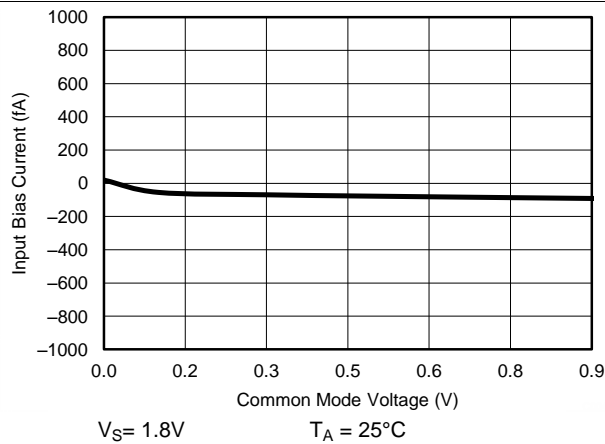

**Figure 9. Input Bias Current vs. Common Mode Voltage**

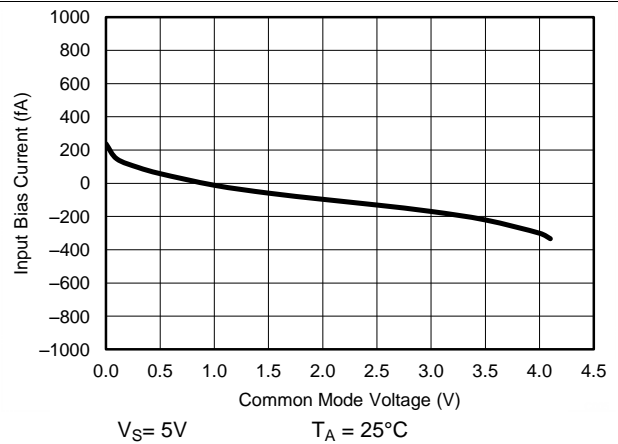

**Figure 10. Input Bias Current vs. Common Mode Voltage**



**Figure 11. Input Bias Current vs. Common Mode Voltage**

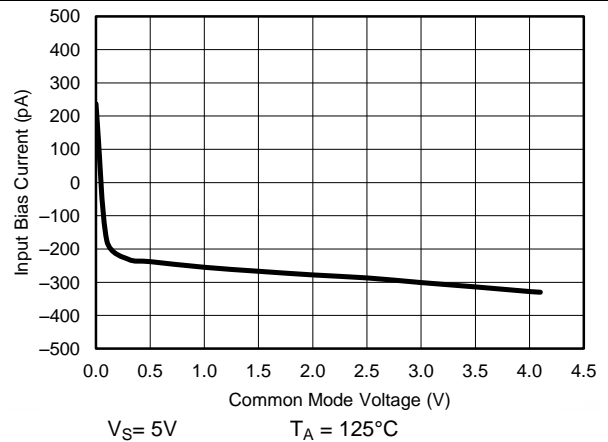

**Figure 12. Input Bias Current vs. Common Mode Voltage**

### Typical Characteristics (continued)

at  $T_A = 25^\circ\text{C}$ ,  $R_L = 10\text{M}\Omega$  to  $V_S/2$ ,  $C_L = 20\text{pF}$ ,  $V_{CM} = V_S / 2\text{V}$  unless otherwise specified.





Typical Characteristics (continued)

at  $T_A = 25^\circ\text{C}$ ,  $R_L = 10\text{M}\Omega$  to  $V_S/2$ ,  $C_L = 20\text{pF}$ ,  $V_{CM} = V_S / 2\text{V}$  unless otherwise specified.



$T_A = 25$        $R_L = 10\text{M}\Omega$        $V_{out} = 200\text{mVpp}$   
 $V_S = \pm 0.9\text{V}$        $C_L = 20\text{pF}$        $A_V = +1$

Figure 19. Small Signal Pulse Response, 1.8V



$T_A = 25$        $R_L = 10\text{M}\Omega$        $V_{out} = 200\text{mVpp}$   
 $V_S = \pm 2.5\text{V}$        $C_L = 20\text{pF}$        $A_V = +1$

Figure 20. Small Signal Pulse Response, 5V

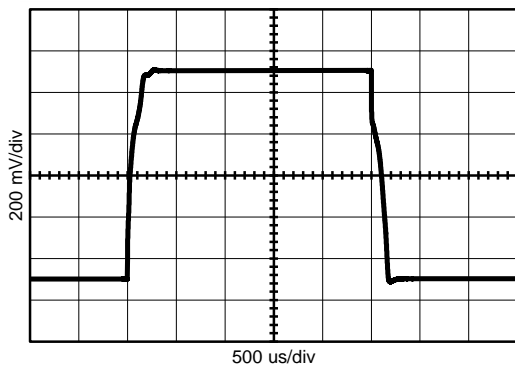

$T_A = 25$        $R_L = 10\text{M}\Omega$        $V_{out} = 1\text{Vpp}$   
 $V_S = \pm 0.9\text{V}$        $C_L = 20\text{pF}$        $A_V = +1$

Figure 21. Large Signal Pulse Response, 1.8V

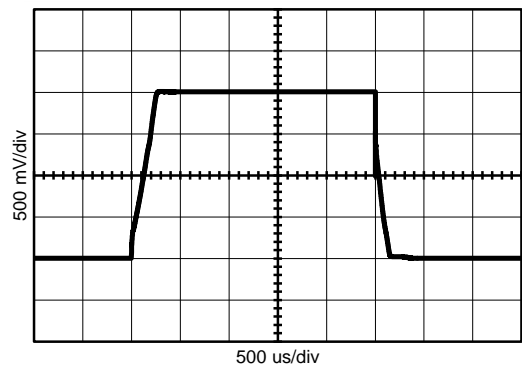

$T_A = 25$        $R_L = 10\text{M}\Omega$        $V_{out} = 2\text{Vpp}$   
 $V_S = \pm 2.5\text{V}$        $C_L = 20\text{pF}$        $A_V = +1$

Figure 22. Large Signal Pulse Response, 5V

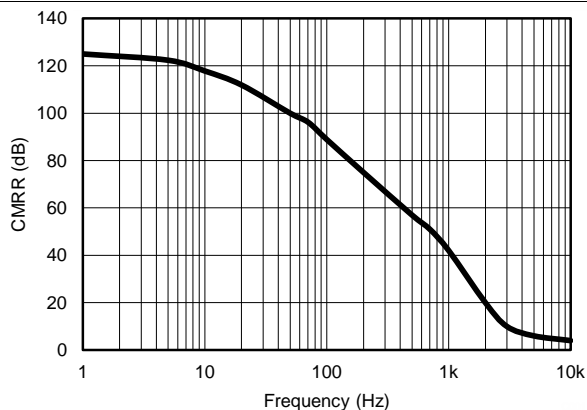

$T_A = 25$        $R_L = 10\text{M}\Omega$        $\Delta V_{CM} = 0.5\text{Vpp}$   
 $V_S = 5\text{V}$        $C_L = 20\text{p}$   
 $V_{CM} = V_S/2$        $A_V = +1$

Figure 23. CMRR vs Frequency

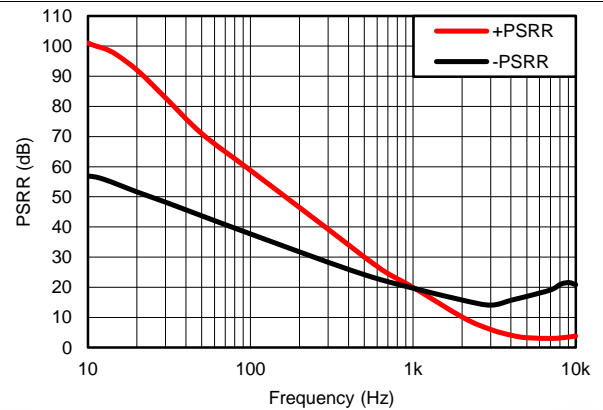

$T_A = 25$        $R_L = 10\text{M}\Omega$        $\Delta V_S = 0.5\text{Vpp}$   
 $V_S = 3.3\text{V}$        $C_L = 20\text{p}$   
 $V_{CM} = V_S/2$        $A_V = +1$

Figure 24.  $\pm$ PSRR vs Frequency

Typical Characteristics (continued)

at  $T_A = 25^\circ\text{C}$ ,  $R_L = 10\text{M}\Omega$  to  $V_S/2$ ,  $C_L = 20\text{pF}$ ,  $V_{CM} = V_S / 2\text{V}$  unless otherwise specified.

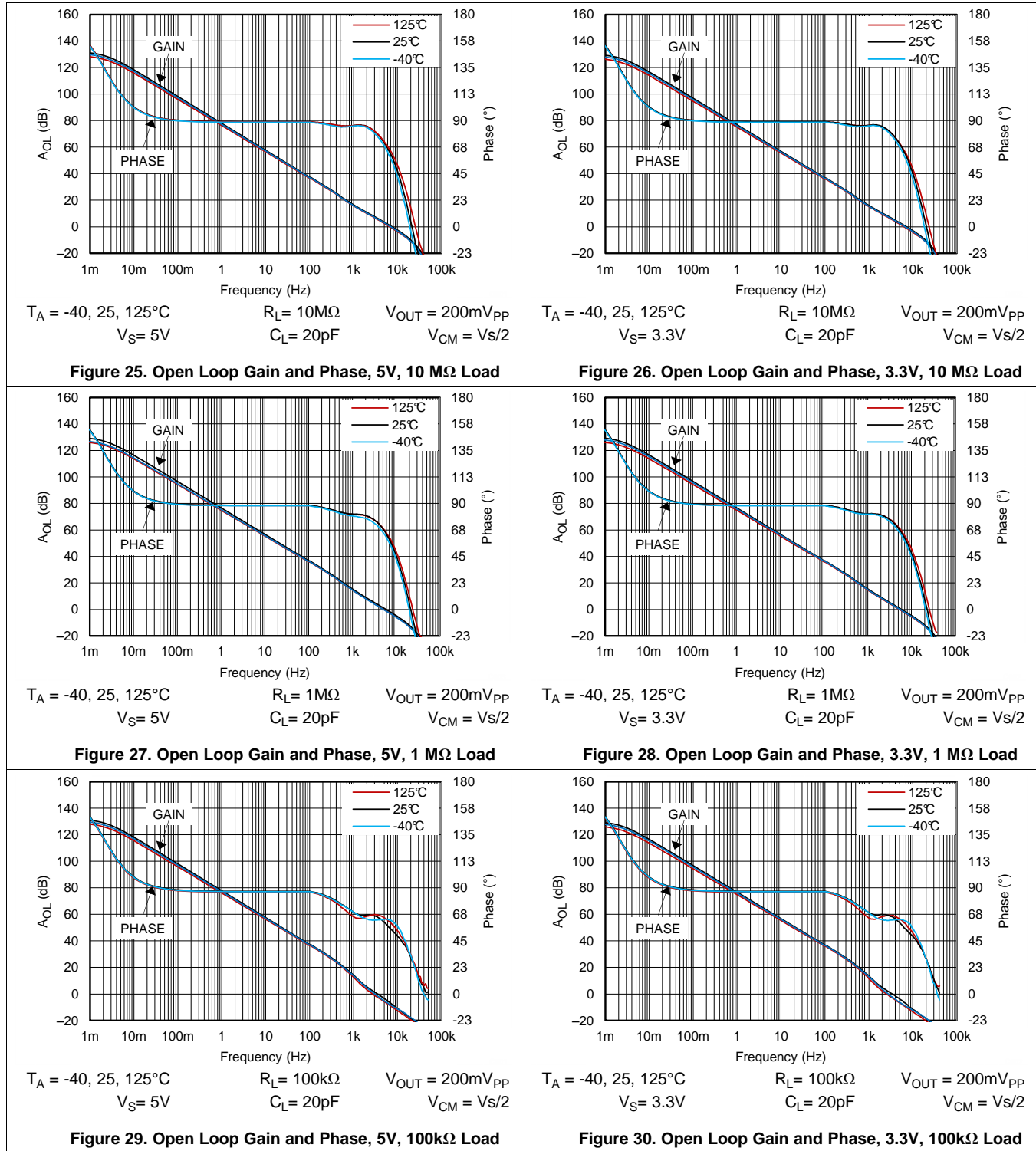

Typical Characteristics (continued)

at  $T_A = 25^\circ\text{C}$ ,  $R_L = 10\text{M}\Omega$  to  $V_S/2$ ,  $C_L = 20\text{pF}$ ,  $V_{CM} = V_S / 2\text{V}$  unless otherwise specified.

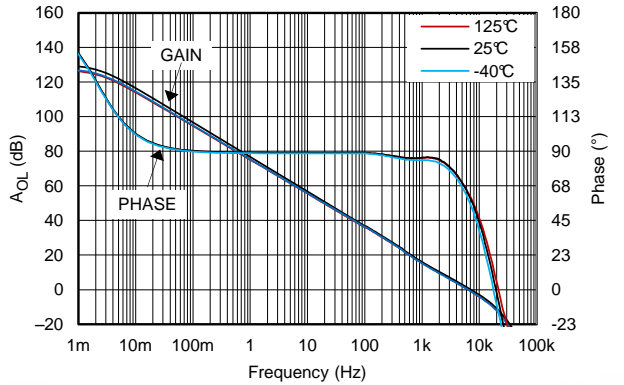

$T_A = -40, 25, 125^\circ\text{C}$   $R_L = 10\text{M}\Omega$   $V_{OUT} = 200\text{mV}_{PP}$   
 $V_S = 1.8\text{V}$   $C_L = 20\text{pF}$   $V_{CM} = V_S/2$

Figure 31. Open Loop Gain and Phase, 1.8V, 10 MΩ Load

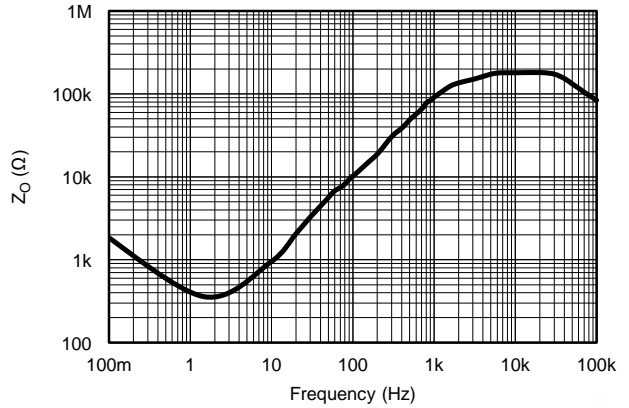

$T_A = 25^\circ\text{C}$   $V_S = 5\text{V}$   $R_L = 10\text{M}\Omega$

Figure 32. Open Loop Output Impedance

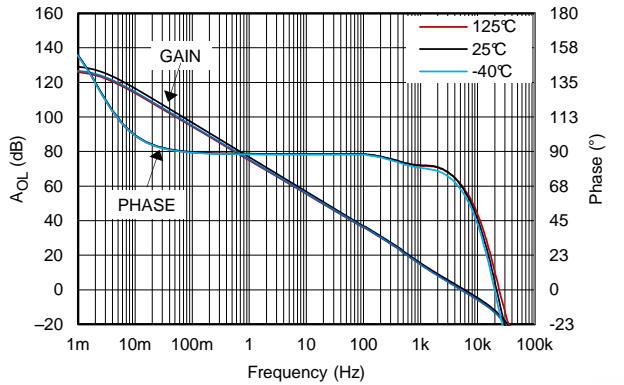

$T_A = -40, 25, 125^\circ\text{C}$   $R_L = 1\text{M}\Omega$   $V_{OUT} = 200\text{mV}_{PP}$   
 $V_S = 1.8\text{V}$   $C_L = 20\text{pF}$   $V_{CM} = V_S/2$

Figure 33. Open Loop Gain and Phase, 1.8V, 1 MΩ Load

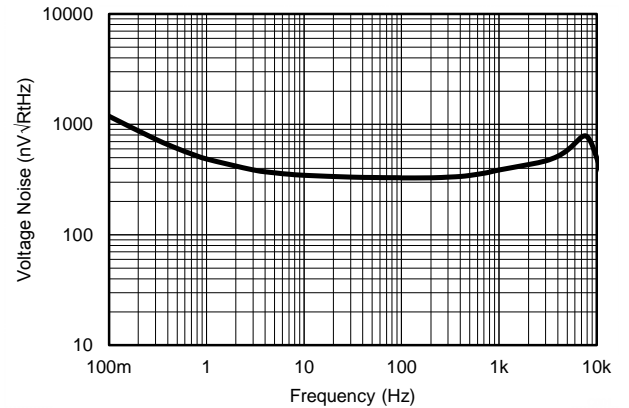

$T_A = 25$   $R_L = 1\text{M}\Omega$   $V_{CM} = V_S/2$   
 $V_S = 5\text{V}$   $C_L = 20\text{pF}$   $A_V = +1$

Figure 34. Input Voltage Noise vs Frequency

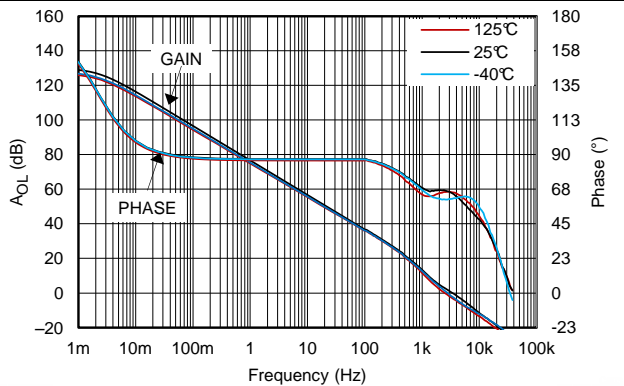

$T_A = -40, 25, 125^\circ\text{C}$   $R_L = 100\text{k}\Omega$   $V_{OUT} = 200\text{mV}_{PP}$   
 $V_S = 1.8\text{V}$   $C_L = 20\text{pF}$   $V_{CM} = V_S/2$

Figure 35. Open Loop Gain and Phase, 1.8V, 100kΩ Load

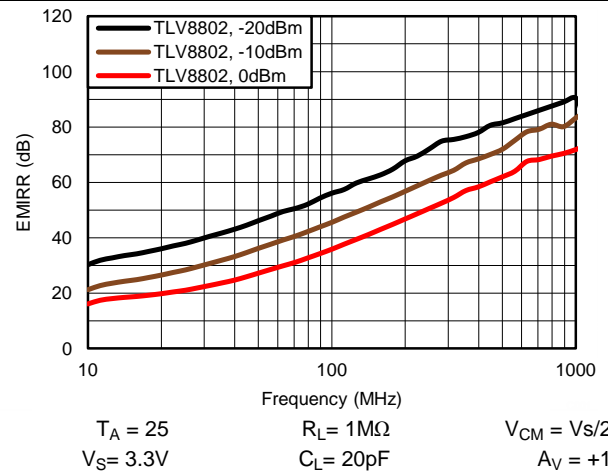

$T_A = 25$   $R_L = 1\text{M}\Omega$   $V_{CM} = V_S/2$   
 $V_S = 3.3\text{V}$   $C_L = 20\text{pF}$   $A_V = +1$

Figure 36. EMIRR Performance

## 7 Detailed Description

### 7.1 Overview

The TLV8801 (single) and TLV8802 (dual) series nanoPower CMOS operational amplifiers are designed for long-life battery-powered and energy harvested applications. They operate on a single supply with operation as low as 1.7 V. The output is rail-to-rail and swings to within 3.5mV of the supplies with a 100kΩ load. The common-mode range extends to the negative supply making it ideal for single-supply applications. EMI protection has been employed internally to reduce the effects of EMI.

Parameters that vary significantly with operating voltages or temperature are shown in the [Typical Characteristics](#) curves.

### 7.2 Functional Block Diagram

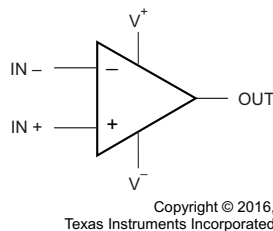

### 7.3 Feature Description

The amplifier's differential inputs consist of a non-inverting input (+IN) and an inverting input (–IN). The amplifier amplifies only the difference in voltage between the two inputs, which is called the differential input voltage. The output voltage of the op-amp  $V_{OUT}$  is given by [Equation 1](#):

$$V_{OUT} = A_{OL} (IN^+ - IN^-)$$

where

- $A_{OL}$  is the open-loop gain of the amplifier, typically around 120 dB (1,000,000x, or 1,000,000 Volts per microvolt).

(1)

### 7.4 Device Functional Modes

#### 7.4.1 Negative-Rail Sensing Input

The input common-mode voltage range of the TLV880x extends from (V-) to (V+) – 0.9 V. In this range, low offset can be expected with a minimum of 80dB CMRR. The TLV880x is protected from output "inversions" or "reversals".

#### 7.4.2 Rail to Rail Output Stage

The TLV880x output voltage swings 3.5 mV from rails at 1.8 V supply, which provides the maximum possible dynamic range at the output. This is particularly important when operating on low supply voltages.

The TLV880x Maximum Output Voltage Swing graph defines the maximum swing possible under a particular output load.

#### 7.4.3 Design Optimization for Nanopower Operation

When designing for ultralow power, choose system feedback components carefully. To minimize quiescent current consumption, select large-value feedback resistors. Any large resistors will react with stray capacitance in the circuit and the input capacitance of the operational amplifier. These parasitic RC combinations can affect the stability of the overall system. A feedback capacitor may be required to assure stability and limit overshoot or gain peaking.

When possible, use AC coupling and AC feedback to reduce static current draw through the feedback elements. Use film or ceramic capacitors since large electrolytics may have large static leakage currents in the nanoamps.

## Device Functional Modes (continued)

### 7.4.4 Driving Capacitive Load

The TLV880x is internally compensated for stable unity gain operation, with a 6 kHz typical gain bandwidth. However, the unity gain follower is the most sensitive configuration to capacitive load. The combination of a capacitive load placed directly on the output of an amplifier along with the amplifier's output impedance creates a phase lag, which reduces the phase margin of the amplifier. If the phase margin is significantly reduced, the response will be under damped which causes peaking in the transfer and, when there is too much peaking, the op amp might start oscillating.

In order to drive heavy (>50pF) capacitive loads, an isolation resistor,  $R_{ISO}$ , should be used, as shown in [Figure 37](#). By using this isolation resistor, the capacitive load is isolated from the amplifier's output. The larger the value of  $R_{ISO}$ , the more stable the amplifier will be. If the value of  $R_{ISO}$  is sufficiently large, the feedback loop will be stable, independent of the value of  $C_L$ . However, larger values of  $R_{ISO}$  result in reduced output swing and reduced output current drive. The recommended value for  $R_{ISO}$  is 30-50k $\Omega$ .



**Figure 37. Resistive Isolation Of Capacitive Load**

## 8 Application and Implementation

### NOTE

Information in the following applications sections is not part of the TI component specification, and TI does not warrant its accuracy or completeness. TI's customers are responsible for determining suitability of components for their purposes. Customers should validate and test their design implementation to confirm system functionality.

### 8.1 Application Information

The TLV880x is a ultra-low power operational amplifier that provides 6 kHz bandwidth with only 320nA typical quiescent current, and near precision drift specifications. These rail-to-rail output amplifiers are specifically designed for battery-powered applications. The input common-mode voltage range extends to the negative supply rail and the output swings to within millivolts of the rails, maintaining a wide dynamic range.

### 8.2 Typical Application: Three Terminal CO Gas Sensor Amplifier

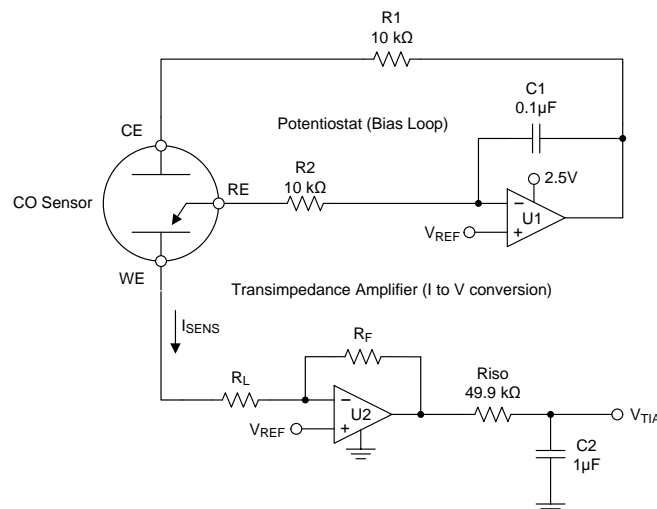

**Figure 38. Three Terminal Gas Sensor Amplifier Schematic**

#### 8.2.1 Design Requirements

Figure 38 shows a simple micropower potentiostat circuit for use with three terminal unbiased CO sensors, though it is applicable to many other type of three terminal gas sensors or electrochemical cells.

The basic sensor has three electrodes; The Sense or Working Electrode (“WE”), Counter Electrode (“CE”) and Reference Electrode (“RE”). A current flows between the CE and WE proportional to the detected concentration.

The RE monitors the potential of the internal reference point. For an unbiased sensor, the WE and RE electrodes must be maintained at the same potential by adjusting the bias on CE. Through the Potentiostat circuit formed by U1, the servo feedback action will maintain the RE pin at a potential set by  $V_{REF}$ .

R1 is to maintain stability due to the large capacitance of the sensor. C1 and R2 form the Potentiostat integrator and set the feedback time constant.

U2 forms a transimpedance amplifier (“TIA”) to convert the resulting sensor current into a proportional voltage. The transimpedance gain, and resulting sensitivity, is set by  $R_F$  according to [Equation 2](#).

$$V_{TIA} = (-I * R_F) + V_{REF} \quad (2)$$

$R_L$  is a load resistor of which the value is normally specified by the sensor manufacturer (typically 10 ohms). The potential at WE is set by the applied  $V_{REF}$ . Riso provides capacitive isolation and, combined with C2, form the output filter and ADC reservoir capacitor to drive the ADC.

## Typical Application: Three Terminal CO Gas Sensor Amplifier (continued)

### 8.2.2 Detailed Design Procedure

For this example, we will be using a CO sensor with a sensitivity of 69nA/ppm. The supply voltage and maximum ADC input voltage is 2.5V, and the maximum concentration is 300ppm.

First the  $V_{REF}$  voltage must be determined. This voltage is a compromise between maximum headroom and resolution, as well as allowance for "footroom" for the minimum swing on the CE terminal, since the CE terminal generally goes negative in relation to the RE potential as the concentration (sensor current) increases. Bench measurements found the difference between CE and RE to be 180mV at 300ppm for this particular sensor.

To allow for negative CE swing "footroom" and voltage drop across the 10k resistor, 300mV was chosen for  $V_{REF}$ .

Therefore +300mV will be used as the minimum  $V_{ZERO}$  to add some headroom.

$$V_{ZERO} = V_{REF} = +300\text{mV}$$

where

- $V_{ZERO}$  is the zero concentration voltage
  - $V_{REF}$  is the reference voltage (300mV)
- (3)

Next we calculate the maximum sensor current at highest expected concentration:

$$I_{SENSMAX} = I_{PERPPM} * \text{ppmMAX} = 69\text{nA} * 300\text{ppm} = 20.7\mu\text{A}$$

where

- $I_{SENSMAX}$  is the maximum expected sensor current
  - $I_{PERPPM}$  is the manufacturer specified sensor current in Amps per ppm
  - ppmMAX is the maximum required ppm reading
- (4)

Now find the available output swing range above the reference voltage available for the measurement:

$$V_{SWING} = V_{OUTMAX} - V_{ZERO} = 2.5\text{V} - 0.3\text{V} = 2.2\text{V}$$

where

- $V_{SWING}$  is the expected change in output voltage
  - $V_{OUTMAX}$  is the maximum amplifier output swing (usually near V+)
- (5)

Now we calculate the transimpedance resistor ( $R_F$ ) value using the maximum swing and the maximum sensor current:

$$R_F = V_{SWING} / I_{SENSMAX} = 2.2\text{V} / 20.7\mu\text{A} = 106.28 \text{ k}\Omega \text{ (we will use } 110 \text{ k}\Omega \text{ for a common value)}$$
(6)

## Typical Application: Three Terminal CO Gas Sensor Amplifier (continued)

### 8.2.3 Application Curve

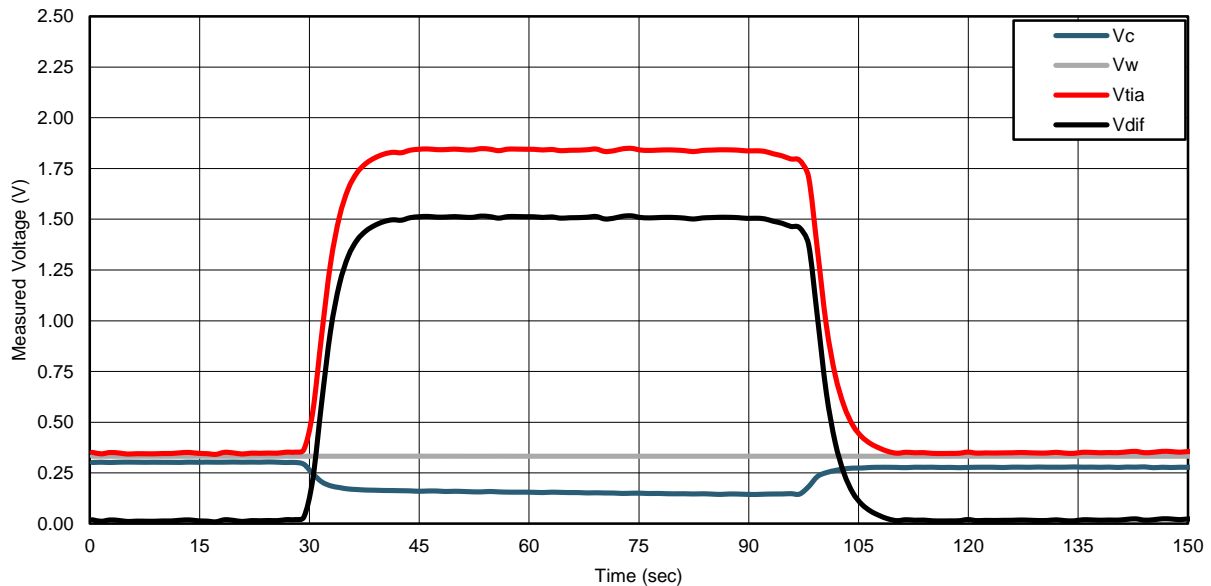

**Figure 39. Monitored Voltages when exposed to 200ppm CO**

Figure 39 shows the resulting circuit voltages when the sensor was exposed to 200ppm step of carbon monoxide gas.  $V_C$  is the monitored CE pin voltage and clearly shows the expected CE voltage dropping below the WE voltage,  $V_W$ , as the concentration increases.

$V_{TIA}$  is the output of the transimpedance amplifier U2.  $V_{DIFF}$  is the calculated difference between  $V_{REF}$  and  $V_{TIA}$ , which will be used for the ppm calculation.

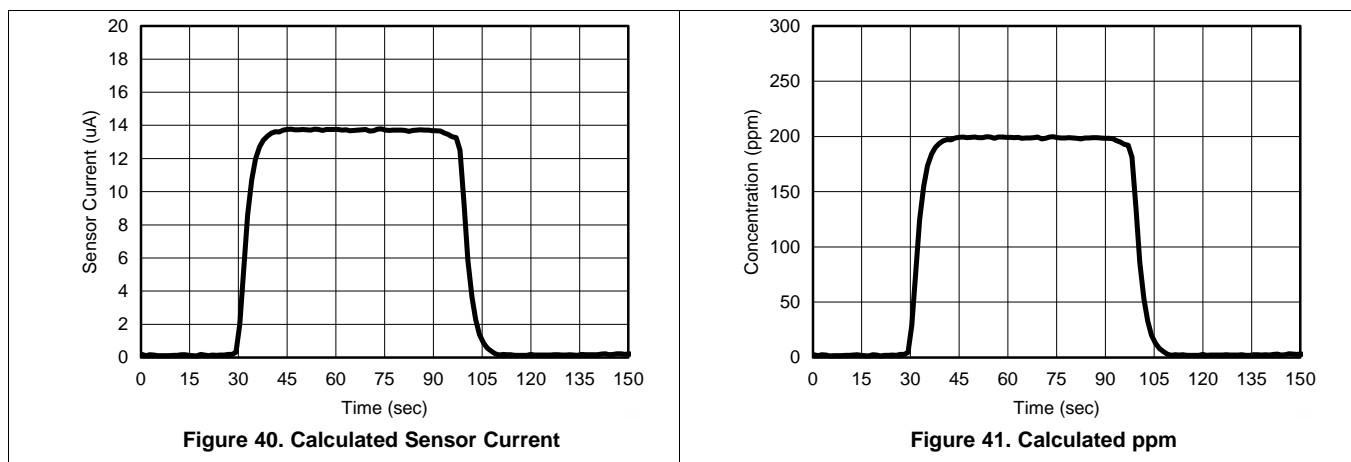

**Figure 40. Calculated Sensor Current**

**Figure 41. Calculated ppm**

Figure 40 shows the calculated sensor current using the formula in Equation 7 :

$$I_{\text{SENSOR}} = V_{\text{DIFF}} / R_F = 1.52\text{V} / 110 \text{ k}\Omega = 13.8\mu\text{A} \quad (7)$$

Equation 8 shows the resulting conversion of the sensor current into ppm.

$$\text{ppm} = I_{\text{SENSOR}} / I_{\text{PERPPM}} = 13.8\mu\text{A} / 69\text{nA} = 200 \quad (8)$$

Total supply current for the amplifier section is less than 700 nA, minus sensor current. Note that the sensor current is sourced from the amplifier output, which in turn comes from the amplifier supply voltage. Therefore, any continuous sensor current must also be included in supply current budget calculations.



### 8.3 Do's and Don'ts

Do properly bypass the power supplies.

Do add series resistance to the output when driving capacitive loads, particularly cables, Muxes and ADC inputs.

Do add series current limiting resistors and external schottky clamp diodes if input voltage is expected to exceed the supplies. Limit the current to 1mA or less (1KΩ per volt).

## 9 Power Supply Recommendations

The TLV880x is specified for operation from 1.7 V to 5.5 V ( $\pm 0.75$  V to  $\pm 2.75$  V) over a  $-40^{\circ}\text{C}$  to  $125^{\circ}\text{C}$  temperature range. Parameters that can exhibit significant variance with regard to operating voltage or temperature are presented in the [Typical Characteristics](#).

### CAUTION

Supply voltages larger than 6 V can permanently damage the device.

For proper operation, the power supplies must be properly decoupled. For decoupling the supply lines it is suggested that 100 nF capacitors be placed as close as possible to the operational amplifier power supply pins. For single supply, place a capacitor between  $V^+$  and  $V^-$  supply leads. For dual supplies, place one capacitor between  $V^+$  and ground, and one capacitor between  $V^-$  and ground.

Low bandwidth nanopower devices do not have good high frequency ( $> 1$  kHz) AC PSRR rejection against high-frequency switching supplies and other 1 kHz and above noise sources, so extra supply filtering is recommended if kilohertz or above noise is expected on the power supply lines.

## 10 Layout

### 10.1 Layout Guidelines

The  $V^+$  pin should be bypassed to ground with a low ESR capacitor.

The optimum placement is closest to the  $V^+$  and ground pins.

Care should be taken to minimize the loop area formed by the bypass capacitor connection between  $V^+$  and ground.

The ground pin should be connected to the PCB ground plane at the pin of the device.

The feedback components should be placed as close to the device as possible to minimize strays.

### 10.2 Layout Example

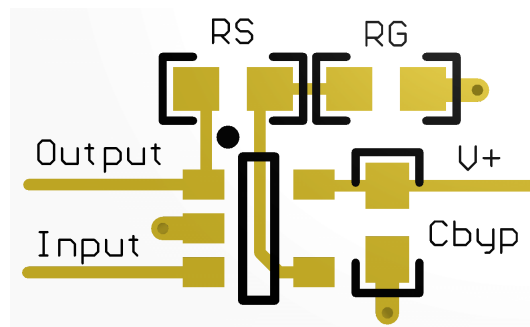

Figure 42. SOT-23 Layout Example (Top View)

## 11 Device and Documentation Support

### 11.1 Device Support

#### 11.1.1 Development Support

TINA-TI SPICE-Based Analog Simulation Program, <http://www.ti.com/tool/tina-ti>

DIP Adapter Evaluation Module, <http://www.ti.com/tool/dip-adapter-evm>

TI Universal Operational Amplifier Evaluation Module, <http://www.ti.com/tool/opampevm>

TI FilterPro Filter Design software, <http://www.ti.com/tool/filterpro>

### 11.2 Related Links

The table below lists quick access links. Categories include technical documents, support and community resources, tools and software, and quick access to sample or buy.

**Table 1. Related Links**

PARTS	PRODUCT FOLDER	SAMPLE & BUY	TECHNICAL DOCUMENTS	TOOLS & SOFTWARE	SUPPORT & COMMUNITY
TLV8801	<a href="#">Click here</a>	<a href="#">Click here</a>	<a href="#">Click here</a>	<a href="#">Click here</a>	<a href="#">Click here</a>
TLV8802	<a href="#">Click here</a>	<a href="#">Click here</a>	<a href="#">Click here</a>	<a href="#">Click here</a>	<a href="#">Click here</a>

### 11.3 Receiving Notification of Documentation Updates

To receive notification of documentation updates, navigate to the device product folder on ti.com. In the upper right corner, click on *Alert me* to register and receive a weekly digest of any product information that has changed. For change details, review the revision history included in any revised document.

### 11.4 Community Resources

The following links connect to TI community resources. Linked contents are provided "AS IS" by the respective contributors. They do not constitute TI specifications and do not necessarily reflect TI's views; see TI's [Terms of Use](#).

**TI E2E™ Online Community** *TI's Engineer-to-Engineer (E2E) Community*. Created to foster collaboration among engineers. At [e2e.ti.com](http://e2e.ti.com), you can ask questions, share knowledge, explore ideas and help solve problems with fellow engineers.

**Design Support** *TI's Design Support* Quickly find helpful E2E forums along with design support tools and contact information for technical support.

### 11.5 Trademarks

E2E is a trademark of Texas Instruments.  
All other trademarks are the property of their respective owners.

### 11.6 Electrostatic Discharge Caution



These devices have limited built-in ESD protection. The leads should be shorted together or the device placed in conductive foam during storage or handling to prevent electrostatic damage to the MOS gates.

### 11.7 Glossary

**SLYZ022** — *TI Glossary*.

This glossary lists and explains terms, acronyms, and definitions.

## 12 Mechanical, Packaging, and Orderable Information

The following pages include mechanical, packaging, and orderable information. This information is the most current data available for the designated devices. This data is subject to change without notice and revision of this document. For browser-based versions of this data sheet, refer to the left-hand navigation.

**PACKAGING INFORMATION**

Orderable Device	Status (1)	Package Type	Package Drawing	Pins	Package Qty	Eco Plan (2)	Lead finish/ Ball material (6)	MSL Peak Temp (3)	Op Temp (°C)	Device Marking (4/5)	Samples
TLV8801DBVR	ACTIVE	SOT-23	DBV	5	3000	RoHS & Green	SN	Level-1-260C-UNLIM	-40 to 125	16DM	<a href="#">Samples</a>
TLV8801DBVT	ACTIVE	SOT-23	DBV	5	250	RoHS & Green	SN	Level-1-260C-UNLIM	-40 to 125	16DM	<a href="#">Samples</a>
TLV8802DGKR	ACTIVE	VSSOP	DGK	8	2500	RoHS & Green	NIPDAUAG	Level-1-260C-UNLIM	-40 to 125	TLV 8802	<a href="#">Samples</a>
TLV8802DGKT	ACTIVE	VSSOP	DGK	8	250	RoHS & Green	NIPDAUAG   SN	Level-1-260C-UNLIM	-40 to 125	TLV 8802	<a href="#">Samples</a>

(1) The marketing status values are defined as follows:

**ACTIVE:** Product device recommended for new designs.

**LIFEBUY:** TI has announced that the device will be discontinued, and a lifetime-buy period is in effect.

**NRND:** Not recommended for new designs. Device is in production to support existing customers, but TI does not recommend using this part in a new design.

**PREVIEW:** Device has been announced but is not in production. Samples may or may not be available.

**OBSELETE:** TI has discontinued the production of the device.

(2) **RoHS:** TI defines "RoHS" to mean semiconductor products that are compliant with the current EU RoHS requirements for all 10 RoHS substances, including the requirement that RoHS substance do not exceed 0.1% by weight in homogeneous materials. Where designed to be soldered at high temperatures, "RoHS" products are suitable for use in specified lead-free processes. TI may reference these types of products as "Pb-Free".

**RoHS Exempt:** TI defines "RoHS Exempt" to mean products that contain lead but are compliant with EU RoHS pursuant to a specific EU RoHS exemption.

**Green:** TI defines "Green" to mean the content of Chlorine (Cl) and Bromine (Br) based flame retardants meet JS709B low halogen requirements of <=1000ppm threshold. Antimony trioxide based flame retardants must also meet the <=1000ppm threshold requirement.

(3) MSL, Peak Temp. - The Moisture Sensitivity Level rating according to the JEDEC industry standard classifications, and peak solder temperature.

(4) There may be additional marking, which relates to the logo, the lot trace code information, or the environmental category on the device.

(5) Multiple Device Markings will be inside parentheses. Only one Device Marking contained in parentheses and separated by a "~" will appear on a device. If a line is indented then it is a continuation of the previous line and the two combined represent the entire Device Marking for that device.

(6) Lead finish/Ball material - Orderable Devices may have multiple material finish options. Finish options are separated by a vertical ruled line. Lead finish/Ball material values may wrap to two lines if the finish value exceeds the maximum column width.

**Important Information and Disclaimer:**The information provided on this page represents TI's knowledge and belief as of the date that it is provided. TI bases its knowledge and belief on information provided by third parties, and makes no representation or warranty as to the accuracy of such information. Efforts are underway to better integrate information from third parties. TI has taken and

continues to take reasonable steps to provide representative and accurate information but may not have conducted destructive testing or chemical analysis on incoming materials and chemicals. TI and TI suppliers consider certain information to be proprietary, and thus CAS numbers and other limited information may not be available for release.

In no event shall TI's liability arising out of such information exceed the total purchase price of the TI part(s) at issue in this document sold by TI to Customer on an annual basis.

**TAPE AND REEL INFORMATION**

**QUADRANT ASSIGNMENTS FOR PIN 1 ORIENTATION IN TAPE**

\*All dimensions are nominal

Device	Package Type	Package Drawing	Pins	SPQ	Reel Diameter (mm)	Reel Width W1 (mm)	A0 (mm)	B0 (mm)	K0 (mm)	P1 (mm)	W (mm)	Pin1 Quadrant
TLV8801DBVR	SOT-23	DBV	5	3000	178.0	8.4	3.2	3.2	1.4	4.0	8.0	Q3
TLV8801DBVT	SOT-23	DBV	5	250	178.0	8.4	3.2	3.2	1.4	4.0	8.0	Q3
TLV8802DGKR	VSSOP	DGK	8	2500	330.0	12.4	5.3	3.4	1.4	8.0	12.0	Q1
TLV8802DGKT	VSSOP	DGK	8	250	178.0	13.4	5.3	3.4	1.4	8.0	12.0	Q1

**TAPE AND REEL BOX DIMENSIONS**

\*All dimensions are nominal

Device	Package Type	Package Drawing	Pins	SPQ	Length (mm)	Width (mm)	Height (mm)
TLV8801DBVR	SOT-23	DBV	5	3000	208.0	191.0	35.0
TLV8801DBVT	SOT-23	DBV	5	250	208.0	191.0	35.0
TLV8802DGKR	VSSOP	DGK	8	2500	364.0	364.0	27.0
TLV8802DGKT	VSSOP	DGK	8	250	202.0	201.0	28.0







# EXAMPLE STENCIL DESIGN

DBV0005A

SOT-23 - 1.45 mm max height

SMALL OUTLINE TRANSISTOR



SOLDER PASTE EXAMPLE  
BASED ON 0.125 mm THICK STENCIL  
SCALE:15X

4214839/F 06/2021

NOTES: (continued)

7. Laser cutting apertures with trapezoidal walls and rounded corners may offer better paste release. IPC-7525 may have alternate design recommendations.
8. Board assembly site may have different recommendations for stencil design.

DGK (S-PDSO-G8)

PLASTIC SMALL-OUTLINE PACKAGE



- NOTES:
- A. All linear dimensions are in millimeters.
  - B. This drawing is subject to change without notice.
  - C. Body length does not include mold flash, protrusions, or gate burrs. Mold flash, protrusions, or gate burrs shall not exceed 0.15 per end.
  - D. Body width does not include interlead flash. Interlead flash shall not exceed 0.50 per side.
  - E. Falls within JEDEC MO-187 variation AA, except interlead flash.



- NOTES:
- A. All linear dimensions are in millimeters.
  - B. This drawing is subject to change without notice.
  - C. Publication IPC-7351 is recommended for alternate designs.
  - D. Laser cutting apertures with trapezoidal walls and also rounding corners will offer better paste release. Customers should contact their board assembly site for stencil design recommendations. Refer to IPC-7525 for other stencil recommendations.
  - E. Customers should contact their board fabrication site for solder mask tolerances between and around signal pads.

## IMPORTANT NOTICE AND DISCLAIMER

TI PROVIDES TECHNICAL AND RELIABILITY DATA (INCLUDING DATA SHEETS), DESIGN RESOURCES (INCLUDING REFERENCE DESIGNS), APPLICATION OR OTHER DESIGN ADVICE, WEB TOOLS, SAFETY INFORMATION, AND OTHER RESOURCES "AS IS" AND WITH ALL FAULTS, AND DISCLAIMS ALL WARRANTIES, EXPRESS AND IMPLIED, INCLUDING WITHOUT LIMITATION ANY IMPLIED WARRANTIES OF MERCHANTABILITY, FITNESS FOR A PARTICULAR PURPOSE OR NON-INFRINGEMENT OF THIRD PARTY INTELLECTUAL PROPERTY RIGHTS.

These resources are intended for skilled developers designing with TI products. You are solely responsible for (1) selecting the appropriate TI products for your application, (2) designing, validating and testing your application, and (3) ensuring your application meets applicable standards, and any other safety, security, regulatory or other requirements.

These resources are subject to change without notice. TI grants you permission to use these resources only for development of an application that uses the TI products described in the resource. Other reproduction and display of these resources is prohibited. No license is granted to any other TI intellectual property right or to any third party intellectual property right. TI disclaims responsibility for, and you will fully indemnify TI and its representatives against, any claims, damages, costs, losses, and liabilities arising out of your use of these resources.

TI's products are provided subject to [TI's Terms of Sale](#) or other applicable terms available either on [ti.com](http://ti.com) or provided in conjunction with such TI products. TI's provision of these resources does not expand or otherwise alter TI's applicable warranties or warranty disclaimers for TI products.

TI objects to and rejects any additional or different terms you may have proposed.

Mailing Address: Texas Instruments, Post Office Box 655303, Dallas, Texas 75265  
Copyright © 2022, Texas Instruments Incorporated