

TLC227x-Q1 Advanced, Rail-To-Rail, LinCMOS™ Operational Amplifiers

1 Features

- AEC-Q100 qualified for automotive applications
 - Temperature grade 1: -40°C to 125°C , T_A
- **Functional Safety-Capable**
 - [Documentation available to aid functional safety system design \(TLC2272-Q1\)](#)
 - [Documentation available to aid functional safety system design \(TLC2272A-Q1\)](#)
- Output swing includes both supply rails
- Low noise: $9\text{ nV}/\sqrt{\text{Hz}}$ typical at $f = 1\text{ kHz}$
- Low input bias current: 1 pA typical
- Fully specified for both single-supply and split-supply operation
- Common-mode input voltage range includes negative rail
- High-gain bandwidth: 2.2 MHz typical
- High slew rate: $3.6\text{ V}/\mu\text{s}$ typical
- Low input offset voltage: $950\text{ }\mu\text{V}$ maximum at $T_A = 25^{\circ}\text{C}$
- Macromodel included

2 Applications

- [Body control module](#)
- [Battery management system](#)
- [Car audio](#)
- [DC/DC converter](#)
- [Electric power steering](#)
- [Engine control unit](#)
- [Gasoline engine](#)
- [Instrument clusters](#)
- [Inverter and motor control](#)
- [On-board charger](#)
- [Telematics control unit](#)
- [Transmission control](#)
- [White goods \(refrigerators, washing machines\)](#)

3 Description

The TLC227x-Q1 are dual and quad, LinCMOS™ operational amplifiers. Both devices exhibit rail-to-rail output performance for increased dynamic range in single- or split-supply applications. The TLC227x-Q1 family offers 2 MHz of bandwidth and $3\text{ V}/\mu\text{s}$ of slew rate for higher-speed applications. These devices offer comparable ac performance while having better noise, input offset voltage, and power dissipation than existing CMOS op amps. The TLC227x-Q1 has a noise voltage of $9\text{ nV}/\sqrt{\text{Hz}}$ —two times lower than competitive solutions.

The TLC227x-Q1, exhibiting high input impedance and low noise, are excellent for small-signal

conditioning for high-impedance sources, such as piezoelectric transducers. In addition, the rail-to-rail output feature, with single- or split-supplies, makes this family a great choice when interfacing with analog-to-digital converters (ADCs).

For precision applications, the TLC227xA-Q1 family is available with a maximum input offset voltage of $950\text{ }\mu\text{V}$. This family is fully characterized at 5 V and $\pm 5\text{ V}$.

These devices offer increased output dynamic range, lower noise voltage, and lower input offset voltage. This enhanced feature set allows the TLC227x-Q1 to be used in a wider range of applications. For applications that require higher output drive and wider input voltage range, see the [TLV2432-Q1](#) and [TLV2442-Q1](#). All the parameters of the TLC227x-Q1 family enables these devices to be applicable in most automotive applications.

Package Information

PART NUMBER	PACKAGE ⁽¹⁾	BODY SIZE (NOM)
TLC2272-Q1, TLC2272A-Q1	SOIC (8)	4.90 mm x 3.91 mm
	TSSOP (8)	3.00 mm x 4.40 mm
TLC2274-Q1, TLC2274A-Q1	SOIC (14)	8.65 mm x 3.91 mm
	TSSOP (14)	5.00 mm x 4.40 mm

(1) For all available packages, see the orderable addendum at the end of the data sheet.

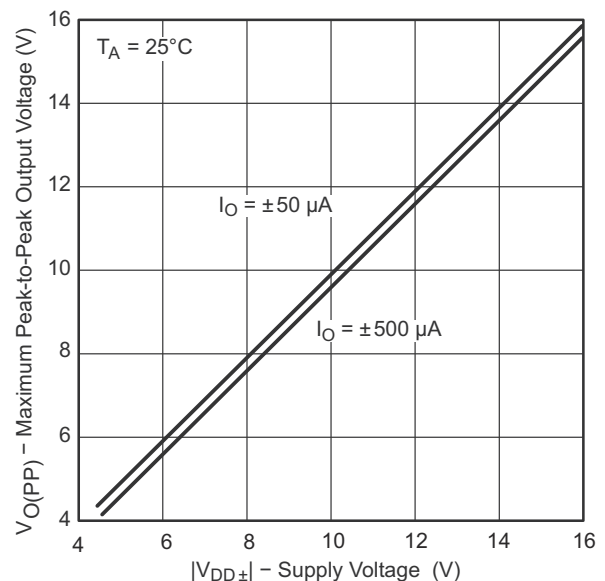

Maximum Peak-To-Peak Output Voltage vs Supply Voltage



Table of Contents

1 Features	1	7.1 Overview.....	22
2 Applications	1	7.2 Functional Block Diagram.....	22
3 Description	1	7.3 Feature Description.....	22
4 Revision History	2	7.4 Device Functional Modes.....	22
5 Pin Configuration and Functions	3	8 Application and Implementation	23
6 Specifications	4	8.1 Application Information.....	23
6.1 Absolute Maximum Ratings.....	4	8.2 Typical Application.....	24
6.2 ESD Ratings.....	4	8.3 Power Supply Recommendations.....	26
6.3 Recommended Operating Conditions.....	4	8.4 Layout.....	26
6.4 Thermal Information.....	5	9 Device and Documentation Support	27
6.5 Electrical Characteristics: $V_{DD} = 5\text{ V}$ (TLC2272-Q1 and TLC2272A-Q1).....	5	9.1 Device Support.....	27
6.6 Electrical Characteristics: $V_{DD\pm} = \pm 5\text{ V}$ (TLC2272-Q1 and TLC2272A-Q1).....	6	9.2 Documentation Support.....	27
6.7 Electrical Characteristics: $V_{DD} = 5\text{ V}$ (TLC2274-Q1 and TLC2274A-Q1).....	8	9.3 Receiving Notification of Documentation Updates.....	27
6.8 Electrical Characteristics: $V_{DD\pm} = \pm 5\text{ V}$ (TLC2274-Q1 and TLC2274A-Q1).....	9	9.4 Support Resources.....	27
6.9 Typical Characteristics.....	11	9.5 Trademarks.....	27
7 Detailed Description	22	9.6 Electrostatic Discharge Caution.....	28
		9.7 Glossary.....	28
		10 Mechanical, Packaging, and Orderable Information	28

4 Revision History

NOTE: Page numbers for previous revisions may differ from page numbers in the current version.

Changes from Revision F (March 2016) to Revision G (August 2022)	Page
• Updated the numbering format for tables, figures, and cross-references throughout the document.....	1
• Added functional safety information to <i>Features</i> bullets.....	1
Changes from Revision E (January 2012) to Revision F (March 2016)	Page
• Added <i>Pin Configuration and Functions</i> section, <i>Feature Description</i> section, <i>Device Functional Modes, Application and Implementation</i> section, <i>Power Supply Recommendations</i> section, <i>Layout</i> section, <i>Device and Documentation Support</i> section, and <i>Mechanical, Packaging, and Orderable Information</i> section.....	1
• Added <i>ESD ratings</i> table.....	4
Changes from Revision D (March 2009) to Revision E (January 2012)	Page
• Deleted <i>ESD ratings</i> table.....	4

5 Pin Configuration and Functions

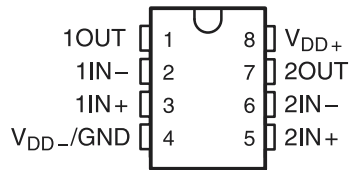

**Figure 5-1. TLC2272-Q1 and TLC2272A-Q1:
D (8-Pin SOIC) or PW (8-Pin TSSOP)
Packages, Top View**

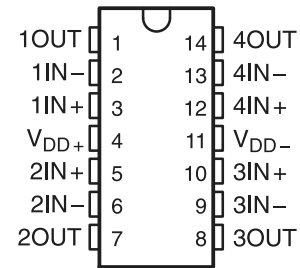

**Figure 5-2. TLC2274-Q1 and TLC2274A-Q1:
D (14-Pin SOIC) or PW (14-Pin TSSOP)
Packages, Top View**

Table 5-1. Pin Functions

NAME	PIN		TYPE	DESCRIPTION
	NO.			
	TLC2272-Q1, TLC2272A-Q1	TLC2274-Q1, TLC2274A-Q1		
1IN+	3	3	Input	Noninverting input, channel 1
1IN-	2	2	Input	Inverting input, channel 1
1OUT	1	1	Output	Output, channel 1
2IN+	5	5	Input	Noninverting input, channel 2
2IN-	6	6	Input	Inverting input, channel 2
2OUT	7	7	Output	Output, channel 2
3IN+	—	10	Input	Noninverting input, channel 3
3IN-	—	9	Input	Inverting input, channel 3
3OUT	—	8	Output	Output, channel 3
4IN+	—	12	Input	Noninverting input, channel 4
4IN-	—	13	Input	Inverting input, channel 4
4OUT	—	14	Output	Output, channel 4
V _{DD+}	8	4	Input	Positive (highest) supply
V _{DD-}	4	11	Input	Negative (lowest) supply

6 Specifications

6.1 Absolute Maximum Ratings

over operating free-air temperature range (unless otherwise noted)⁽¹⁾

	MIN	MAX	UNIT
Supply voltage, V_{DD+} ⁽²⁾		8	V
V_{DD-} ⁽²⁾	-8		V
Differential input voltage, V_{ID} ⁽³⁾		±16	V
Input voltage, V_I (any input) ⁽²⁾	$V_{DD-} - 0.3$	V_{DD+}	V
Input current, I_I (any input)		±5	mA
Output current, I_O		±50	mA
Total current into V_{DD+}		±50	mA
Total current out of V_{DD-}		±50	mA
Duration of short-circuit current at (or below) 25°C ⁽⁴⁾	Unlimited		
Operating free-air temperature range, T_A	-40	125	°C
Lead temperature 1,6 mm (1/16 inch) from case for 10 seconds	D or PW package		260
Storage temperature, T_{stg}	-65	150	°C

- (1) Stresses beyond those listed under *Absolute Maximum Ratings* may cause permanent damage to the device. These are stress ratings only, which do not imply functional operation of the device at these or any other conditions beyond those indicated under [Section 6.3](#). Exposure to absolute-maximum-rated conditions for extended periods may affect device reliability.
- (2) All voltage values, except differential voltages, are with respect to the midpoint between V_{DD+} and V_{DD-} .
- (3) Differential voltages are at $IN+$ with respect to $IN-$. Excessive current will flow if input is brought below $V_{DD-} - 0.3$ V.
- (4) The output can be shorted to either supply. Temperature or supply voltages must be limited so that the maximum dissipation rating is not exceeded.

6.2 ESD Ratings

		VALUE	UNIT
$V_{(ESD)}$	Electrostatic discharge	Human-body model (HBM), per AEC Q100-002 ⁽¹⁾ HBM ESD classification level 2	±2000
		Charged-device model (CDM), per AEC Q100-011 CDM ESD classification level C6	±1000

- (1) AEC Q100-002 indicates that HBM stressing shall be in accordance with the ANSI/ESDA/JEDEC JS-001 specification.

6.3 Recommended Operating Conditions

over operating free-air temperature range (unless otherwise noted)

		MIN	MAX	UNIT
$V_{DD±}$	Supply voltage	±2.2	±8	V
V_I	Input voltage	V_{DD-}	$V_{DD+} - 1.5$	V
V_{IC}	Common-mode input voltage	V_{DD-}	$V_{DD+} - 1.5$	V
T_A	Operating free-air temperature	-40	125	°C

6.4 Thermal Information

THERMAL METRIC ⁽¹⁾		TLC2272-Q1, TLC2272A-Q1		TLC2274-Q1, TLC2274A-Q1		UNIT
		D (SOIC)	PW (TSSOP)	D (SOIC)	PW (TSSOP)	
		8 PINS	8 PINS	14 PINS	14 PINS	
R _{θJA}	Junction-to-ambient thermal resistance	115.6	175.8	83.8	111.6	°C/W
R _{θJC(top)}	Junction-to-case (top) thermal resistance	61.8	58.8	43.2	41.2	°C/W
R _{θJB}	Junction-to-board thermal resistance	55.9	104.3	38.4	54.7	°C/W
ψ _{JT}	Junction-to-top characterization parameter	14.3	5.9	9.4	3.9	°C/W
ψ _{JB}	Junction-to-board characterization parameter	55.4	102.3	38.1	53.9	°C/W
R _{θJC(bot)}	Junction-to-case (bottom) thermal resistance	—	—	—	—	°C/W

(1) For more information about traditional and new thermal metrics, see the [Semiconductor and IC Package Thermal Metrics application report](#).

6.5 Electrical Characteristics: V_{DD} = 5 V (TLC2272-Q1 and TLC2272A-Q1)

at specified free-air temperature, V_{DD} = 5 V; T_A = 25°C, unless otherwise noted.

PARAMETER		TEST CONDITIONS		MIN	TYP	MAX	UNIT
V _{IO}	Input offset voltage	V _{IC} = 0 V, V _{DD±} = ±2.5 V, V _O = 0 V, R _S = 50 Ω	TLC2272-Q1	T _A = 25°C	300	2500	μV
			TLC2272A-Q1		300	950	
			TLC2272-Q1	Full Range ⁽¹⁾		3000	
			TLC2272A-Q1		1500		
α _{VIO}	Temperature coefficient of input offset voltage	V _{IC} = 0 V, V _{DD±} = ±2.5 V, V _O = 0 V, R _S = 50 Ω		2		μV/°C	
	Input offset voltage long-term drift ⁽²⁾	V _{IC} = 0 V, V _{DD±} = ±2.5 V, V _O = 0 V, R _S = 50 Ω		0.002		μV/mo	
I _{IO}	Input offset current	V _{IC} = 0 V, V _{DD±} = ±2.5 V, V _O = 0 V, R _S = 50 Ω	T _A = 25°C	0.5	60	pA	
			Full Range ⁽¹⁾		800		
I _{IB}	Input bias current	V _{IC} = 0 V, V _{DD±} = ±2.5 V, V _O = 0 V, R _S = 50 Ω	T _A = 25°C	1	60	pA	
			Full Range ⁽¹⁾		800		
V _{ICR}	Common-mode input voltage	R _S = 50 Ω; V _{IO} ≤ 5 mV	T _A = 25°C	-0.3	2.5	4	V
			Full Range ⁽¹⁾	0	2.5	3.5	
V _{OH}	High-level output voltage	I _{OH} = -200 μA	I _{OH} = -20 μA		4.99		V
			T _A = 25°C	4.85	4.93		
				Full Range ⁽¹⁾	4.85		
			T _A = 25°C	4.25	4.65		
Full Range ⁽¹⁾	4.25						
V _{OL}	Low-level output voltage	V _{IC} = 2.5 V	I _{OL} = 50 μA		0.01		V
			I _{OL} = 500 μA	T _A = 25°C	0.09	0.15	
				Full Range ⁽¹⁾		0.15	
			I _{OL} = 5 mA	T _A = 25°C	0.9	1.5	
Full Range ⁽¹⁾		1.5					
A _{VD}	Large-signal differential voltage amplification	V _{IC} = 2.5 V, V _O = 1 V to 4 V	R _L = 10 kΩ ⁽³⁾	T _A = 25°C	10	35	V/mV
			R _L = 1 MΩ ⁽³⁾	Full Range ⁽¹⁾	10		
					175		
r _{id}	Differential input resistance			10 ¹²		Ω	
r _i	Common-mode input resistance			10 ¹²		Ω	
c _i	Common-mode input capacitance	f = 10 kHz, P package		8		pF	
z _o	Closed-loop output impedance	f = 1 MHz, A _v = 10		140		Ω	
CMRR	Common-mode rejection ratio	V _{IC} = 0 V to 2.7 V, V _O = 2.5 V, R _S = 50 Ω	T _A = 25°C	70	75	dB	
			Full Range ⁽¹⁾	70			
k _{SVR}	Supply-voltage rejection ratio (ΔV _{DD} / ΔV _{IO})	V _{DD} = 4.4 V to 16 V, V _{IC} = V _{DD} / 2, no load	T _A = 25°C	80	95	dB	
			Full Range ⁽¹⁾	80			

6.5 Electrical Characteristics: $V_{DD} = 5\text{ V}$ (TLC2272-Q1 and TLC2272A-Q1) (continued)

 at specified free-air temperature, $V_{DD} = 5\text{ V}$; $T_A = 25^\circ\text{C}$, unless otherwise noted.

PARAMETER		TEST CONDITIONS		MIN	TYP	MAX	UNIT
I_{DD}	Supply current	$V_O = 2.5\text{ V}$, no load	$T_A = 25^\circ\text{C}$		2.2	3	mA
			Full Range ⁽¹⁾			3	
SR	Slew rate at unity gain	$V_O = 0.5\text{ V}$ to 2.5 V , $R_L = 10\text{ k}\Omega$ ⁽³⁾ , $C_L = 100\text{ pF}$ ⁽³⁾	$T_A = 25^\circ\text{C}$		2.3	3.6	V/ μs
			Full Range ⁽¹⁾		1.7		
V_n	Equivalent input noise voltage	f = 10 Hz			50		nV/ $\sqrt{\text{Hz}}$
			f = 1 kHz			9	
V_{NPP}	Peak-to-peak equivalent input noise voltage	f = 0.1 Hz to 1 Hz			1		μV
			f = 0.1 Hz to 10 Hz			1.4	
I_n	Equivalent input noise current				0.6		fA/ $\sqrt{\text{Hz}}$
THD+N	Total harmonic distortion + noise	$V_O = 0.5\text{ V}$ to 2.5 V , f = 20 kHz, $R_L = 10\text{ k}\Omega$ ⁽³⁾	$A_V = 1$		0.0013%		
			$A_V = 10$		0.004%		
			$A_V = 100$		0.03%		
	Gain-bandwidth product	f = 10 kHz, $R_L = 10\text{ k}\Omega$ ⁽³⁾ , $C_L = 100\text{ pF}$ ⁽³⁾			2.18		MHz
B_{OM}	Maximum output-swing bandwidth	$V_{O(PP)} = 2\text{ V}$, $A_V = 1$, $R_L = 10\text{ k}\Omega$ ⁽³⁾ , $C_L = 100\text{ pF}$ ⁽³⁾			1		MHz
t_s	Settling time	$A_V = -1$, $R_L = 10\text{ k}\Omega$ ⁽³⁾ , Step = 0.5 V to 2.5 V, $C_L = 100\text{ pF}$ ⁽³⁾	To 0.1%		1.5		μs
			To 0.01%		2.6		
ϕ_m	Phase margin at unity gain	$R_L = 10\text{ k}\Omega$ ⁽³⁾ , $C_L = 100\text{ pF}$ ⁽³⁾			50°		
	Gain margin	$R_L = 10\text{ k}\Omega$ ⁽³⁾ , $C_L = 100\text{ pF}$ ⁽³⁾			10		dB

 (1) $T_A = -40^\circ\text{C}$ to 125°C .

 (2) Typical values are based on the input offset voltage shift observed through 168 hours of operating life test at $T_A = 150^\circ\text{C}$ extrapolated to $T_A = 25^\circ\text{C}$ using the Arrhenius equation and assuming an activation energy of 0.96 eV.

(3) Referenced to 0 V.

6.6 Electrical Characteristics: $V_{DD\pm} = \pm 5\text{ V}$ (TLC2272-Q1 and TLC2272A-Q1)

 at specified free-air temperature, $V_{DD\pm} = \pm 5\text{ V}$; $T_A = 25^\circ\text{C}$, unless otherwise noted.

PARAMETER		TEST CONDITIONS		MIN	TYP	MAX	UNIT	
V_{IO}	Input offset voltage	$V_{IC} = 0\text{ V}$, $V_O = 0\text{ V}$, $R_S = 50\ \Omega$	TLC2272-Q1	$T_A = 25^\circ\text{C}$	300	2500	μV	
			TLC2272A-Q1		300	950		
			TLC2272-Q1	Full Range ⁽¹⁾		3000		
			TLC2272A-Q1			1500		
α_{VIO}	Temperature coefficient of input offset voltage	$V_{IC} = 0\text{ V}$, $V_O = 0\text{ V}$, $R_S = 50\ \Omega$			2		$\mu\text{V}/^\circ\text{C}$	
	Input offset voltage long-term drift ⁽²⁾	$V_{IC} = 0\text{ V}$, $V_O = 0\text{ V}$, $R_S = 50\ \Omega$			0.002		$\mu\text{V}/\text{mo}$	
I_{IO}	Input offset current	$V_{IC} = 0\text{ V}$, $V_O = 0\text{ V}$, $R_S = 50\ \Omega$	$T_A = 25^\circ\text{C}$		0.5	60	pA	
			Full Range ⁽¹⁾			800		
I_{IB}	Input bias current	$V_{IC} = 0\text{ V}$, $V_O = 0\text{ V}$, $R_S = 50\ \Omega$	$T_A = 25^\circ\text{C}$		1	60	pA	
			Full Range ⁽¹⁾			800		
V_{ICR}	Common-mode input voltage	$R_S = 50\ \Omega$; $ V_{IO} \leq 5\text{ mV}$	$T_A = 25^\circ\text{C}$		-5.3	0	4	V
			Full Range ⁽¹⁾		-5	0	3.5	
V_{OM+}	Maximum positive peak output voltage	$I_O = -20\ \mu\text{A}$	$T_A = 25^\circ\text{C}$		4.85	4.93	V	
			Full Range ⁽¹⁾		4.85			
			$T_A = 25^\circ\text{C}$		4.25	4.65		
			Full Range ⁽¹⁾		4.25			
V_{OM-}	Maximum negative peak output voltage	$V_{IC} = 0\text{ V}$	$I_O = 50\ \mu\text{A}$		-4.99		V	
			$I_O = 500\ \mu\text{A}$	$T_A = 25^\circ\text{C}$		-4.85		-4.91
				Full Range ⁽¹⁾		-4.85		
			$I_O = 5\text{ mA}$	$T_A = 25^\circ\text{C}$		-3.5		-4.1
Full Range ⁽¹⁾		-3.5						

6.6 Electrical Characteristics: $V_{DD\pm} = \pm 5\text{ V}$ (TLC2272-Q1 and TLC2272A-Q1) (continued)

at specified free-air temperature, $V_{DD\pm} = \pm 5\text{ V}$; $T_A = 25^\circ\text{C}$, unless otherwise noted.

PARAMETER		TEST CONDITIONS		MIN	TYP	MAX	UNIT
A_{VD}	Large-signal differential voltage amplification	$V_O = \pm 4\text{ V}$	$R_L = 10\text{ k}\Omega$	$T_A = 25^\circ\text{C}$	20	50	V/mV
				Full Range ⁽¹⁾	20		
			$R_L = 1\text{ M}\Omega$			300	
r_{id}	Differential input resistance				10^{12}		Ω
r_i	Common-mode input resistance				10^{12}		Ω
c_i	Common-mode input capacitance	$f = 10\text{ kHz}$, P package			8		pF
z_o	Closed-loop output impedance	$f = 1\text{ MHz}$, $A_V = 10$			130		Ω
CMRR	Common-mode rejection ratio	$V_{IC} = -5\text{ V to } 2.7\text{ V}$, $V_O = 0\text{ V}$, $R_S = 50\ \Omega$	$T_A = 25^\circ\text{C}$	75	80		dB
			Full Range ⁽¹⁾	75			
k_{SVR}	Supply-voltage rejection ratio ($\Delta V_{DD} / \Delta V_{IO}$)	$V_{DD+} = 2.2\text{ V to } \pm 8\text{ V}$, $V_{IC} = 0\text{ V}$, no load	$T_A = 25^\circ\text{C}$	80	95		dB
			Full Range ⁽¹⁾	80			
I_{DD}	Supply current	$V_O = 0\text{ V}$, no load	$T_A = 25^\circ\text{C}$		2.4	3	mA
			Full Range ⁽¹⁾			3	
SR	Slew rate at unity gain	$V_O = \pm 2.3\text{ V}$, $R_L = 10\text{ k}\Omega$, $C_L = 100\text{ pF}$	$T_A = 25^\circ\text{C}$	2.3	3.6		V/ μs
			Full Range ⁽¹⁾	1.7			
V_n	Equivalent input noise voltage	$f = 10\text{ Hz}$			50		nV/ $\sqrt{\text{Hz}}$
		$f = 1\text{ kHz}$			9		
V_{NPP}	Peak-to-peak equivalent input noise voltage	$f = 0.1\text{ Hz to } 1\text{ Hz}$			1		μV
		$f = 0.1\text{ Hz to } 10\text{ Hz}$			1.4		
I_n	Equivalent input noise current				0.6		fA/ $\sqrt{\text{Hz}}$
THD+N	Total harmonic distortion + noise	$V_O = \pm 2.3$, $f = 20\text{ kHz}$, $R_L = 10\text{ k}\Omega$	$A_V = 1$		0.0011%		
			$A_V = 10$		0.004%		
			$A_V = 100$		0.03%		
	Gain-bandwidth product	$f = 10\text{ kHz}$, $R_L = 10\text{ k}\Omega$, $C_L = 100\text{ pF}$			2.25		MHz
B_{OM}	Maximum output-swing bandwidth	$V_{O(PP)} = 4.6\text{ V}$, $A_V = 1$, $R_L = 10\text{ k}\Omega$, $C_L = 100\text{ pF}$			0.54		MHz
t_s	Settling time	$A_V = -1$, $R_L = 10\text{ k}\Omega$, Step = $-2.3\text{ V to } 2.3\text{ V}$, $C_L = 100\text{ pF}$	To 0.1%		1.5		μs
			To 0.01%		3.2		
ϕ_m	Phase margin at unity gain	$R_L = 10\text{ k}\Omega$, $C_L = 100\text{ pF}$			52°		
	Gain margin	$R_L = 10\text{ k}\Omega$, $C_L = 100\text{ pF}$			10		dB

(1) $T_A = -40^\circ\text{C to } 125^\circ\text{C}$.

(2) Typical values are based on the input offset voltage shift observed through 168 hours of operating life test at $T_A = 150^\circ\text{C}$ extrapolated to $T_A = 25^\circ\text{C}$ using the Arrhenius equation and assuming an activation energy of 0.96 eV.

6.7 Electrical Characteristics: $V_{DD} = 5\text{ V}$ (TLC2274-Q1 and TLC2274A-Q1)

at specified free-air temperature, $V_{DD} = 5\text{ V}$; $T_A = 25^\circ\text{C}$, unless otherwise noted.

PARAMETER		TEST CONDITIONS		MIN	TYP	MAX	UNIT	
V_{IO}	Input offset voltage	$V_{IC} = 0\text{ V}$, $V_{DD\pm} = \pm 2.5\text{ V}$, $V_O = 0\text{ V}$, $R_S = 50\ \Omega$	TLC2274-Q1	$T_A = 25^\circ\text{C}$	300	2500	μV	
			TLC2274A-Q1		300	950		
			TLC2274-Q1	Full Range ⁽¹⁾				3000
			TLC2274A-Q1					1500
α_{VIO}	Temperature coefficient of input offset voltage	$V_{IC} = 0\text{ V}$, $V_{DD\pm} = \pm 2.5\text{ V}$, $V_O = 0\text{ V}$, $R_S = 50\ \Omega$			2		$\mu\text{V}/^\circ\text{C}$	
	Input offset voltage long-term drift ⁽²⁾	$V_{IC} = 0\text{ V}$, $V_{DD\pm} = \pm 2.5\text{ V}$, $V_O = 0\text{ V}$, $R_S = 50\ \Omega$			0.002		$\mu\text{V}/\text{mo}$	
I_{IO}	Input offset current	$V_{IC} = 0\text{ V}$, $V_{DD\pm} = \pm 2.5\text{ V}$, $V_O = 0\text{ V}$, $R_S = 50\ \Omega$	$T_A = 25^\circ\text{C}$	0.5	60	pA		
			Full Range ⁽¹⁾				800	
I_{IB}	Input bias current	$V_{IC} = 0\text{ V}$, $V_{DD\pm} = \pm 2.5\text{ V}$, $V_O = 0\text{ V}$, $R_S = 50\ \Omega$	$T_A = 25^\circ\text{C}$	1	60	pA		
			Full Range ⁽¹⁾				800	
V_{ICR}	Common-mode input voltage	$R_S = 50\ \Omega$; $ V_{IO} \leq 5\text{ mV}$	$T_A = 25^\circ\text{C}$	-0.3	2.5	4	V	
			Full Range ⁽¹⁾	0	2.5	3.5		
V_{OH}	High-level output voltage	$I_{OH} = -20\ \mu\text{A}$			4.99	V		
			$T_A = 25^\circ\text{C}$	4.85	4.93			
			Full Range ⁽¹⁾	4.85				
			$T_A = 25^\circ\text{C}$	4.25	4.65			
V_{OL}	Low-level output voltage	$V_{IC} = 2.5\text{ V}$	$I_{OL} = 50\ \mu\text{A}$		0.01	V		
			$I_{OL} = 500\ \mu\text{A}$	$T_A = 25^\circ\text{C}$	0.09		0.15	
				Full Range ⁽¹⁾			0.15	
			$I_{OL} = 5\text{ mA}$	$T_A = 25^\circ\text{C}$	0.9		1.5	
Full Range ⁽¹⁾		1.5						
A_{VD}	Large-signal differential voltage amplification	$V_{IC} = 2.5\text{ V}$, $V_O = 1\text{ V to }4\text{ V}$	$R_L = 10\ \text{k}\Omega^{(3)}$	$T_A = 25^\circ\text{C}$	10	35	V/mV	
			$R_L = 1\ \text{M}\Omega^{(3)}$	Full Range ⁽¹⁾	10			
						175		
r_{id}	Differential input resistance				10^{12}	Ω		
r_i	Common-mode input resistance				10^{12}	Ω		
c_i	Common-mode input capacitance	$f = 10\ \text{kHz}$, P package			8	pF		
z_o	Closed-loop output impedance	$f = 1\ \text{MHz}$, $A_V = 10$			140	Ω		
CMRR	Common-mode rejection ratio	$V_{IC} = 0\text{ V to }2.7\text{ V}$, $V_O = 2.5\text{ V}$, $R_S = 50\ \Omega$	$T_A = 25^\circ\text{C}$	70	75	dB		
			Full Range ⁽¹⁾	70				
k_{SVR}	Supply-voltage rejection ratio ($\Delta V_{DD} / \Delta V_{IO}$)	$V_{DD} = 4.4\text{ V to }16\text{ V}$, $V_{IC} = V_{DD} / 2$, no load	$T_A = 25^\circ\text{C}$	80	95	dB		
			Full Range ⁽¹⁾	80				
I_{DD}	Supply current	$V_O = 2.5\text{ V}$, no load	$T_A = 25^\circ\text{C}$	4.4	6	mA		
			Full Range ⁽¹⁾		6			
SR	Slew rate at unity gain	$V_O = 0.5\text{ V to }2.5\text{ V}$, $R_L = 10\ \text{k}\Omega^{(3)}$, $C_L = 100\ \text{pF}^{(3)}$	$T_A = 25^\circ\text{C}$	2.3	3.6	V/ μs		
			Full Range ⁽¹⁾	1.7				
V_n	Equivalent input noise voltage	$f = 10\ \text{Hz}$		50	nV/ $\sqrt{\text{Hz}}$			
		$f = 1\ \text{kHz}$		9				
V_{NPP}	Peak-to-peak equivalent input noise voltage	$f = 0.1\ \text{Hz to }1\ \text{Hz}$		1	μV			
		$f = 0.1\ \text{Hz to }10\ \text{Hz}$		1.4				
I_n	Equivalent input noise current			0.6	fA/ $\sqrt{\text{Hz}}$			
THD+N	Total harmonic distortion + noise	$V_O = 0.5\text{ V to }2.5\text{ V}$, $f = 20\ \text{kHz}$, $R_L = 10\ \text{k}\Omega^{(3)}$	$A_V = 1$	0.0013%				
			$A_V = 10$	0.004%				
			$A_V = 100$	0.03%				
	Gain-bandwidth product	$f = 10\ \text{kHz}$, $R_L = 10\ \text{k}\Omega^{(3)}$, $C_L = 100\ \text{pF}^{(3)}$			2.18	MHz		
B_{OM}	Maximum output-swing bandwidth	$V_{O(PP)} = 2\text{ V}$, $A_V = 1$, $R_L = 10\ \text{k}\Omega^{(3)}$, $C_L = 100\ \text{pF}^{(3)}$			1	MHz		

6.7 Electrical Characteristics: $V_{DD} = 5\text{ V}$ (TLC2274-Q1 and TLC2274A-Q1) (continued)

at specified free-air temperature, $V_{DD} = 5\text{ V}$; $T_A = 25^\circ\text{C}$, unless otherwise noted.

PARAMETER		TEST CONDITIONS		MIN	TYP	MAX	UNIT
t_s	Settling time	$A_V = -1$, $R_L = 10\text{ k}\Omega^{(3)}$, Step = 0.5 V to 2.5 V, $C_L = 100\text{ pF}^{(3)}$	To 0.1%		1.5		μs
			To 0.01%		2.6		
ϕ_m	Phase margin at unity gain	$R_L = 10\text{ k}\Omega^{(3)}$, $C_L = 100\text{ pF}^{(3)}$			50°		
	Gain margin	$R_L = 10\text{ k}\Omega^{(3)}$, $C_L = 100\text{ pF}^{(3)}$			10		dB

- $T_A = -40^\circ\text{C}$ to 125°C .
- Typical values are based on the input offset voltage shift observed through 168 hours of operating life test at $T_A = 150^\circ\text{C}$ extrapolated to $T_A = 25^\circ\text{C}$ using the Arrhenius equation and assuming an activation energy of 0.96 eV.
- Referenced to 0 V.

6.8 Electrical Characteristics: $V_{DD\pm} = \pm 5\text{ V}$ (TLC2274-Q1 and TLC2274A-Q1)

at specified free-air temperature, $V_{DD\pm} = \pm 5\text{ V}$; $T_A = 25^\circ\text{C}$, unless otherwise noted.

PARAMETER		TEST CONDITIONS		MIN	TYP	MAX	UNIT	
V_{IO}	Input offset voltage	$V_{IC} = 0\text{ V}$, $V_O = 0\text{ V}$, $R_S = 50\ \Omega$	TLC2274-Q1	$T_A = 25^\circ\text{C}$	300	2500	μV	
			TLC2274A-Q1		300	950		
			TLC2274-Q1	Full Range ⁽¹⁾		3000		
			TLC2274A-Q1			1500		
α_{VIO}	Temperature coefficient of input offset voltage	$V_{IC} = 0\text{ V}$, $V_O = 0\text{ V}$, $R_S = 50\ \Omega$			2		$\mu\text{V}/^\circ\text{C}$	
	Input offset voltage long-term drift ⁽²⁾	$V_{IC} = 0\text{ V}$, $V_O = 0\text{ V}$, $R_S = 50\ \Omega$			0.002		$\mu\text{V}/\text{mo}$	
I_{IO}	Input offset current	$V_{IC} = 0\text{ V}$, $V_O = 0\text{ V}$, $R_S = 50\ \Omega$	$T_A = 25^\circ\text{C}$		0.5	60	pA	
			Full Range ⁽¹⁾			800		
I_{IB}	Input bias current	$V_{IC} = 0\text{ V}$, $V_O = 0\text{ V}$, $R_S = 50\ \Omega$	$T_A = 25^\circ\text{C}$		1	60	pA	
			Full Range ⁽¹⁾			800		
V_{ICR}	Common-mode input voltage	$R_S = 50\ \Omega$; $ V_{IO} \leq 5\text{ mV}$	$T_A = 25^\circ\text{C}$		-5.3	0	4	V
			Full Range ⁽¹⁾		-5	0	3.5	
V_{OM+}	Maximum positive peak output voltage	$I_O = -20\ \mu\text{A}$	$T_A = 25^\circ\text{C}$		4.85	4.93	V	
			Full Range ⁽¹⁾		4.85			
			$T_A = 25^\circ\text{C}$		4.25	4.65		
			Full Range ⁽¹⁾		4.25			
V_{OM-}	Maximum negative peak output voltage	$V_{IC} = 0\text{ V}$	$I_O = 50\ \mu\text{A}$			-4.99	V	
			$I_O = 500\ \mu\text{A}$	$T_A = 25^\circ\text{C}$		-4.85		-4.91
				Full Range ⁽¹⁾		-4.85		
			$I_O = 5\text{ mA}$	$T_A = 25^\circ\text{C}$		-3.5		-4.1
Full Range ⁽¹⁾		-3.5						
A_{VD}	Large-signal differential voltage amplification	$V_O = \pm 4\text{ V}$	$R_L = 10\text{ k}\Omega$	$T_A = 25^\circ\text{C}$	20	50	V/mV	
				Full Range ⁽¹⁾	20			
			$R_L = 1\text{ M}\Omega$		300			
r_{id}	Differential input resistance				10^{12}		Ω	
r_i	Common-mode input resistance				10^{12}		Ω	
c_i	Common-mode input capacitance	$f = 10\text{ kHz}$, P package			8		pF	
z_o	Closed-loop output impedance	$f = 1\text{ MHz}$, $A_V = 10$			130		Ω	
CMRR	Common-mode rejection ratio	$V_{IC} = -5\text{ V}$ to 2.7 V , $V_O = 0\text{ V}$, $R_S = 50\ \Omega$	$T_A = 25^\circ\text{C}$		75	80	dB	
			Full Range ⁽¹⁾		75			
k_{SVR}	Supply-voltage rejection ratio ($\Delta V_{DD} / \Delta V_{IO}$)	$V_{DD+} = 2.2\text{ V}$ to $\pm 8\text{ V}$, $V_{IC} = 0\text{ V}$, no load	$T_A = 25^\circ\text{C}$		80	95	dB	
			Full Range ⁽¹⁾		80			
I_{DD}	Supply current	$V_O = 0\text{ V}$, no load	$T_A = 25^\circ\text{C}$		4.8	6	mA	
			Full Range ⁽¹⁾			6		

6.8 Electrical Characteristics: $V_{DD\pm} = \pm 5\text{ V}$ (TLC2274-Q1 and TLC2274A-Q1) (continued)

at specified free-air temperature, $V_{DD\pm} = \pm 5\text{ V}$; $T_A = 25^\circ\text{C}$, unless otherwise noted.

PARAMETER		TEST CONDITIONS		MIN	TYP	MAX	UNIT
SR	Slew rate at unity gain	$V_O = \pm 2.3\text{ V}$, $R_L = 10\text{ k}\Omega$, $C_L = 100\text{ pF}$	$T_A = 25^\circ\text{C}$	2.3	3.6		V/ μs
			Full Range ⁽¹⁾	1.7			
V_n	Equivalent input noise voltage		f = 10 Hz		50		nV/ $\sqrt{\text{Hz}}$
			f = 1 kHz		9		
V_{NPP}	Peak-to-peak equivalent input noise voltage		f = 0.1 Hz to 1 Hz		1		μV
			f = 0.1 Hz to 10 Hz		1.4		
I_n	Equivalent input noise current				0.6		fA/ $\sqrt{\text{Hz}}$
THD+N	Total harmonic distortion + noise	$V_O = \pm 2.3$, f = 20 kHz, $R_L = 10\text{ k}\Omega$	$A_V = 1$		0.0011%		
			$A_V = 10$		0.004%		
			$A_V = 100$		0.03%		
	Gain-bandwidth product	f = 10 kHz, $R_L = 10\text{ k}\Omega$, $C_L = 100\text{ pF}$			2.25		MHz
B_{OM}	Maximum output-swing bandwidth	$V_{O(PP)} = 4.6\text{ V}$, $A_V = 1$, $R_L = 10\text{ k}\Omega$, $C_L = 100\text{ pF}$			0.54		MHz
t_s	Settling time	$A_V = -1$, $R_L = 10\text{ k}\Omega$, Step = -2.3 V to 2.3 V , $C_L = 100\text{ pF}$	To 0.1%		1.5		μs
			To 0.01%		3.2		
ϕ_m	Phase margin at unity gain	$R_L = 10\text{ k}\Omega$, $C_L = 100\text{ pF}$			52°		
	Gain margin	$R_L = 10\text{ k}\Omega$, $C_L = 100\text{ pF}$			10		dB

(1) $T_A = -40^\circ\text{C}$ to 125°C .

(2) Typical values are based on the input offset voltage shift observed through 168 hours of operating life test at $T_A = 150^\circ\text{C}$ extrapolated to $T_A = 25^\circ\text{C}$ using the Arrhenius equation and assuming an activation energy of 0.96 eV.

6.9 Typical Characteristics

Table 6-1. Table of Graphs

			FIGURE ⁽¹⁾
V_{IO}	Input offset voltage	Distribution	1, 2, 3, 4
		vs Common-mode voltage	5, 6
α_{VIO}	Input offset voltage temperature coefficient	Distribution	7, 8, 9, 10 ⁽²⁾
I_B / I_{IO}	Input bias and input offset current	vs Free-air temperature	11 ⁽²⁾
V_I	Input voltage	vs Supply voltage	12
		vs Free-air temperature	13 ⁽²⁾
V_{OH}	High-level output voltage	vs High-level output current	14 ⁽²⁾
V_{OL}	Low-level output voltage	vs Low-level output current	15, 16 ⁽²⁾
V_{OM+}	Maximum positive peak output voltage	vs Output current	17 ⁽²⁾
V_{OM-}	Maximum negative peak output voltage	vs Output current	18 ⁽²⁾
$V_{O(PP)}$	Maximum peak-to-peak output voltage	vs Frequency	19
I_{OS}	Short-circuit output current	vs Supply voltage	20
		vs Free-air temperature	21 ⁽²⁾
V_O	Output voltage	vs Differential input voltage	22, 23
A_{VD}	Large-signal differential voltage amplification	vs Load resistance	24
	Large-signal differential voltage amplification and phase margin	vs Frequency	25, 26
	Large-signal differential voltage amplification	vs Free-air temperature	27 ⁽²⁾ , 28 ⁽²⁾
Z_0	Output impedance	vs Frequency	29, 30
CMRR	Common-mode rejection ratio	vs Frequency	31
		vs Free-air temperature	32
k_{SVR}	Supply-voltage rejection ratio	vs Frequency	33, 34
		vs Free-air temperature	35 ⁽²⁾
I_{DD}	Supply current	vs Supply voltage	36 ⁽²⁾ , 37 ⁽²⁾
		vs Free-air temperature	38 ⁽²⁾ , 39 ⁽²⁾
SR	Slew rate	vs Load Capacitance	40
		vs Free-air temperature	41 ⁽²⁾
V_O	Inverting large-signal pulse response		42, 43
	Voltage-follower large-signal pulse response		44, 45
	Inverting small-signal pulse response		46, 47
	Voltage-follower small-signal pulse response		48, 49
V_n	Equivalent input noise voltage	vs Frequency	50, 51
	Noise voltage over a 10-second period		52
	Integrated noise voltage	vs Frequency	53
THD+N	Total harmonic distortion + noise	vs Frequency	54
	Gain-bandwidth product	vs Supply voltage	55
		vs Free-air temperature	56 ⁽²⁾
Φ_m	Phase margin	vs Load capacitance	57
	Gain margin	vs Load capacitance	58

(1) For all graphs where $V_{DD} = 5$ V, all loads are referenced to 2.5 V.

(2) Data at high and low temperatures are applicable only within the rated operating free-air temperature ranges of the various devices.

6.9 Typical Characteristics (continued)

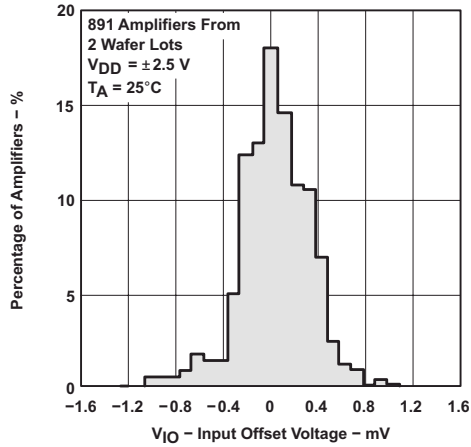

Figure 6-1. Distribution of TLC2272-Q1 Input Offset Voltage

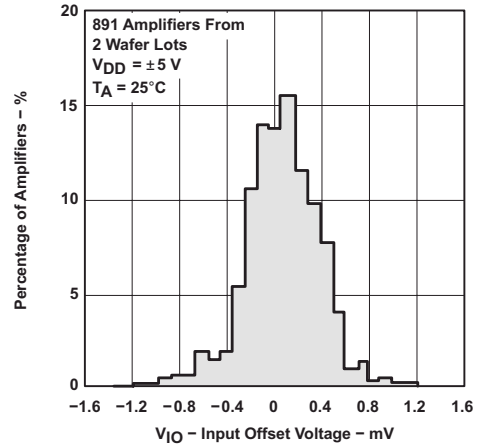

Figure 6-2. Distribution of TLC2272-Q1 Input Offset Voltage

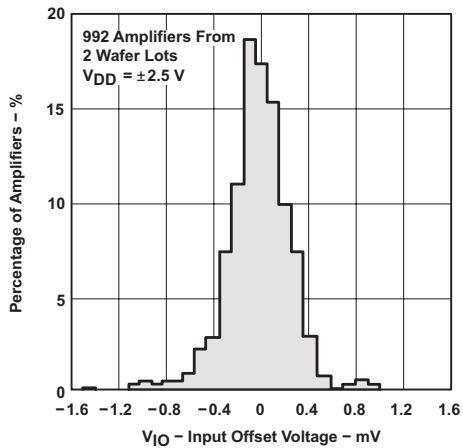

Figure 6-3. Distribution of TLC2274-Q1 Input Offset Voltage

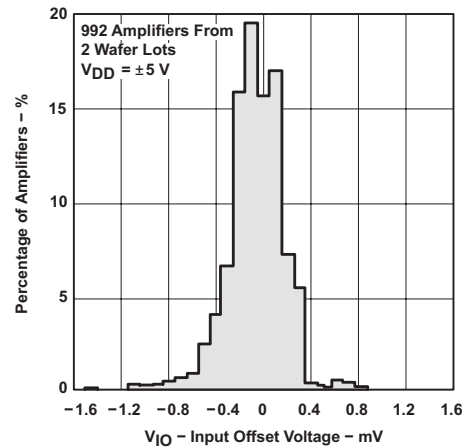

Figure 6-4. Distribution of TLC2274-Q1 Input Offset Voltage

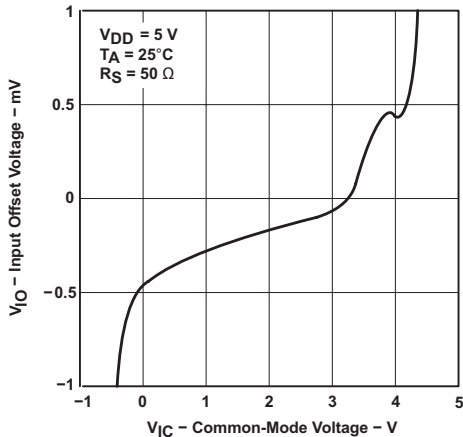

Figure 6-5. Input Offset Voltage vs Common-Mode Voltage

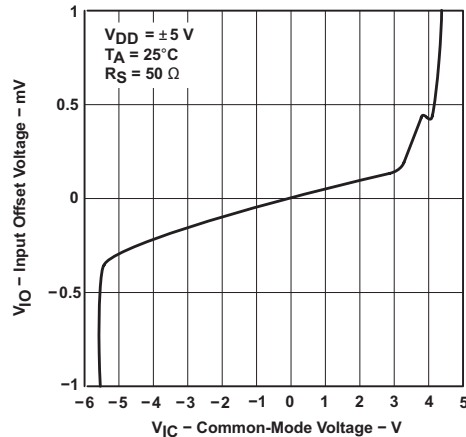

Figure 6-6. Input Offset Voltage vs Common-Mode Voltage

6.9 Typical Characteristics (continued)

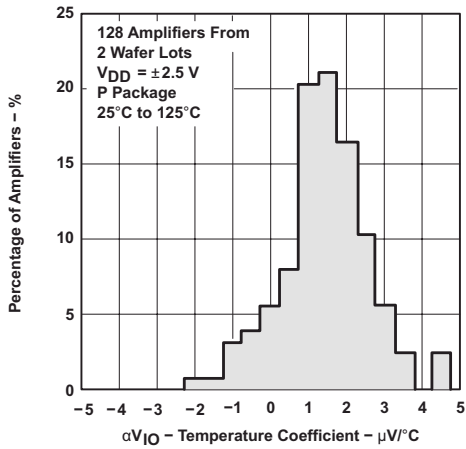

Figure 6-7. Distribution of TLC2272-Q1 vs Input Offset Voltage Temperature Coefficient

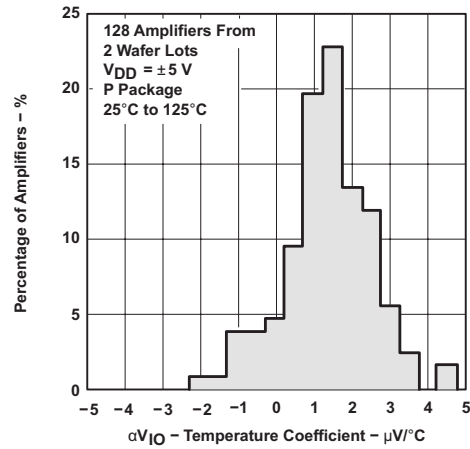

Figure 6-8. Distribution of TLC2272-Q1 vs Input Offset Voltage Temperature Coefficient

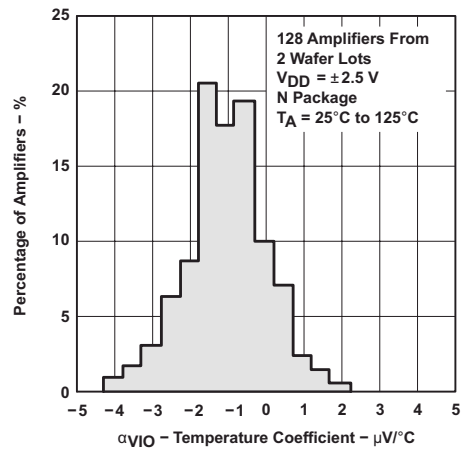

Figure 6-9. Distribution of TLC2274-Q1 vs Input Offset Voltage Temperature Coefficient

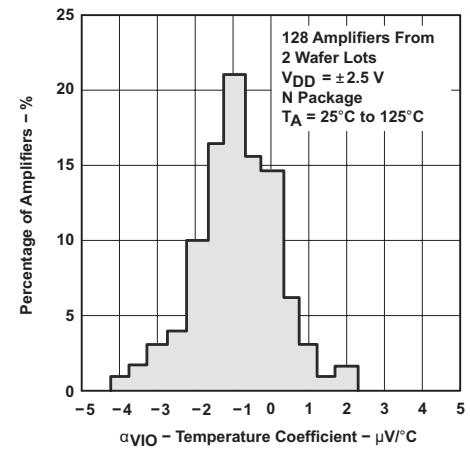

Figure 6-10. Distribution of TLC2274-Q1 vs Input Offset Voltage Temperature Coefficient

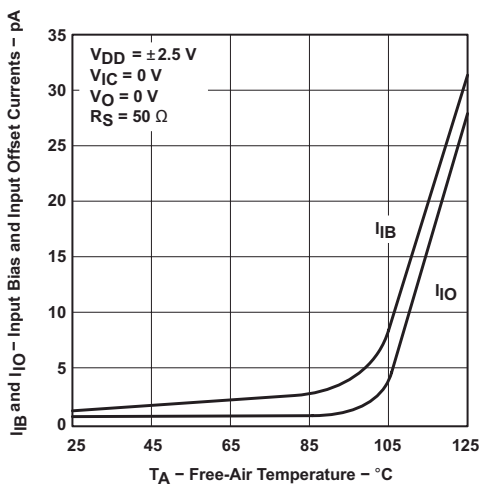

Figure 6-11. Input Bias and Input Offset Current vs Free-Air Temperature

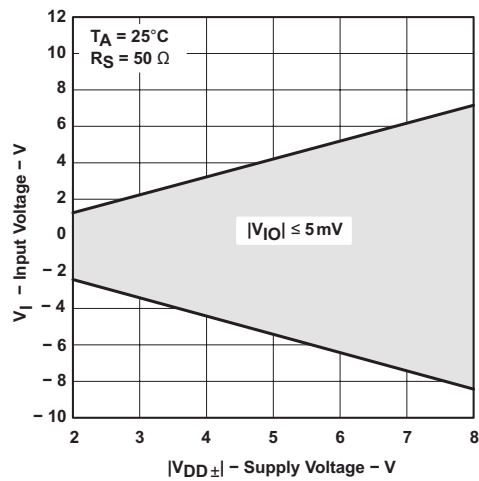

Figure 6-12. Input Voltage vs Supply Voltage

6.9 Typical Characteristics (continued)

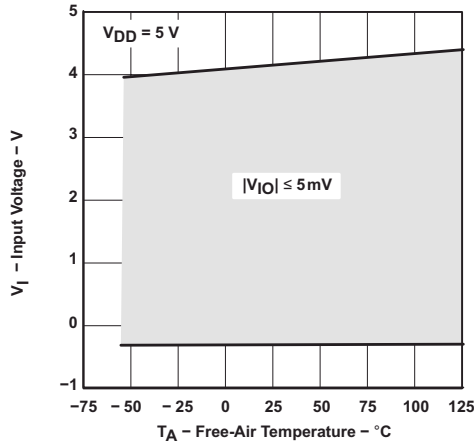

Figure 6-13. Input Voltage vs Free-Air Temperature

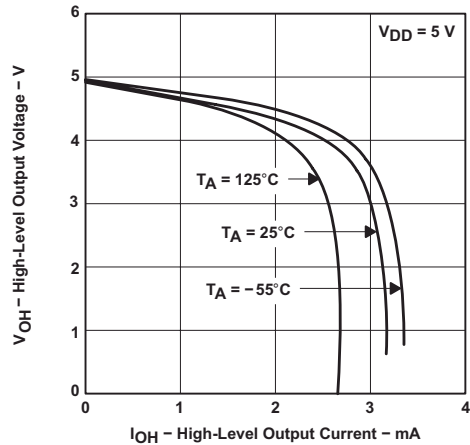

Figure 6-14. High-Level Output Voltage vs High-Level Output Current

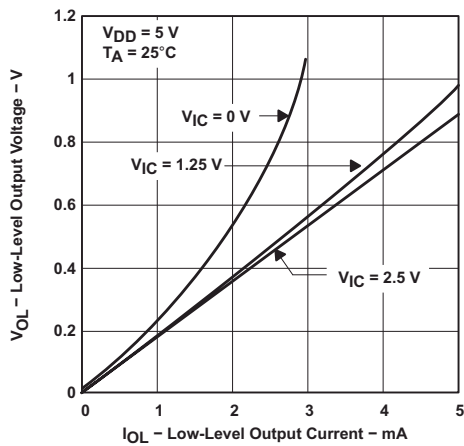

Figure 6-15. Low-Level Output Voltage vs Low-Level Output Current

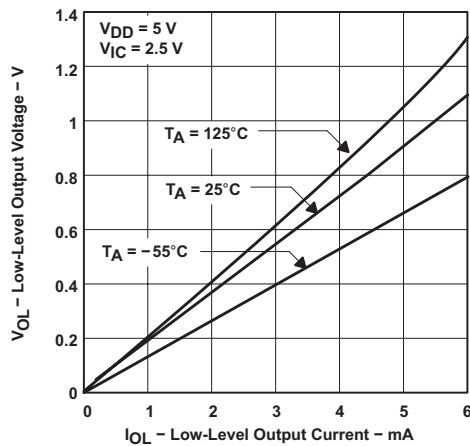

Figure 6-16. Low-Level Output Voltage vs Low-Level Output Current

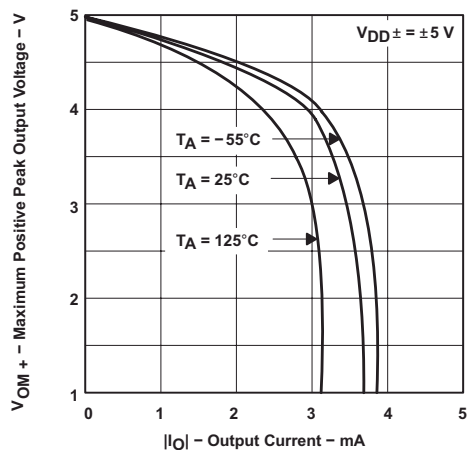

Figure 6-17. Maximum Positive Peak Output Voltage vs Output Current

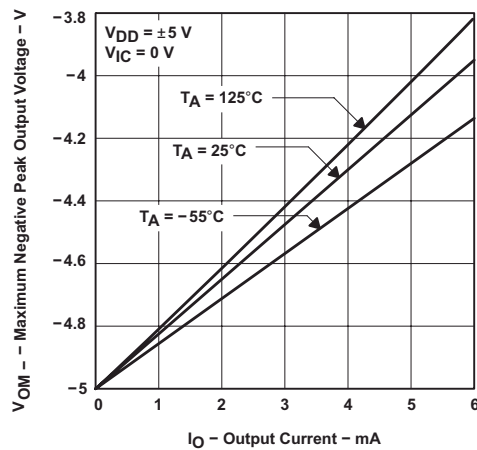

Figure 6-18. Maximum Positive Peak Output Voltage vs Output Current

6.9 Typical Characteristics (continued)

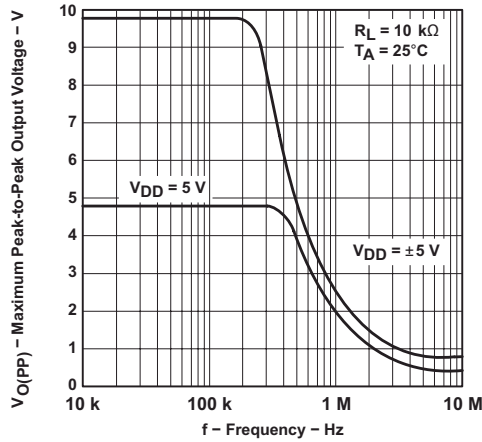

Figure 6-19. Maximum Peak-to-Peak Output Voltage vs Frequency

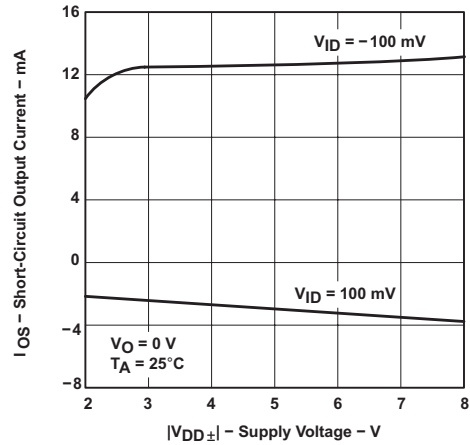

Figure 6-20. Short-Circuit Output Current vs Supply Voltage

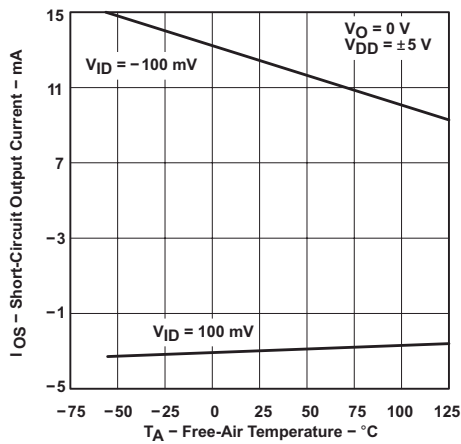

Figure 6-21. Short-Circuit Output Current vs Free-Air Temperature

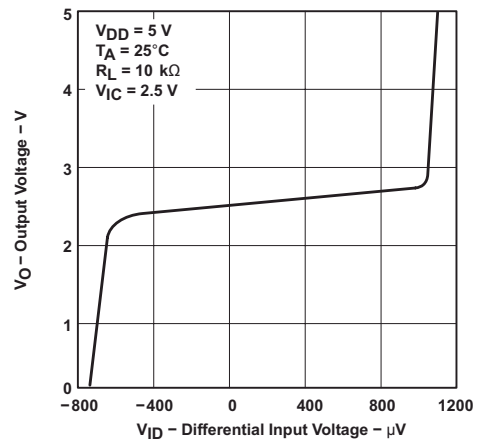

Figure 6-22. Output Voltage vs Differential Input Voltage

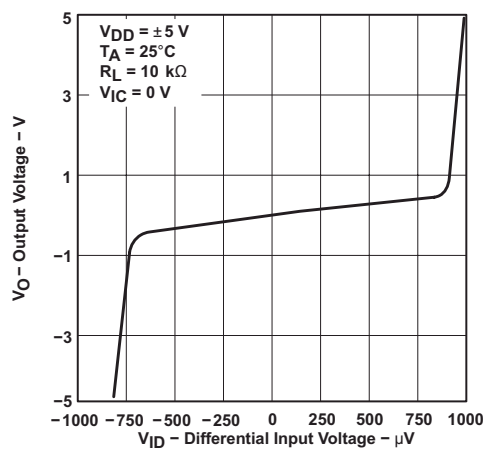

Figure 6-23. Output Voltage vs Differential Input Voltage

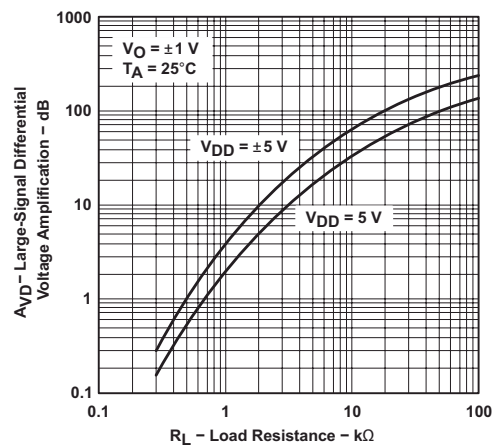

Figure 6-24. Large-Signal Differential Voltage Amplification vs Load Resistance

6.9 Typical Characteristics (continued)

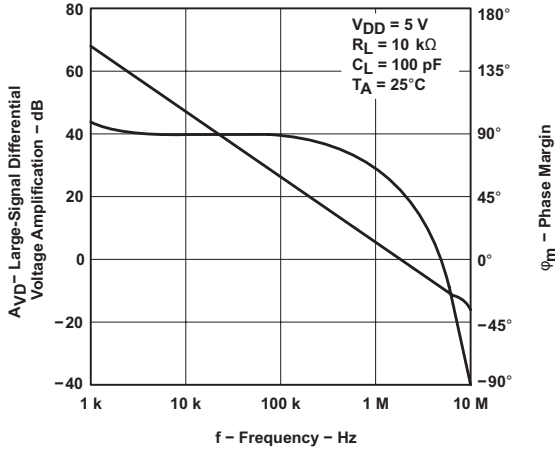

Figure 6-25. Large-Signal Differential Voltage Amplification and Phase Margin vs Frequency

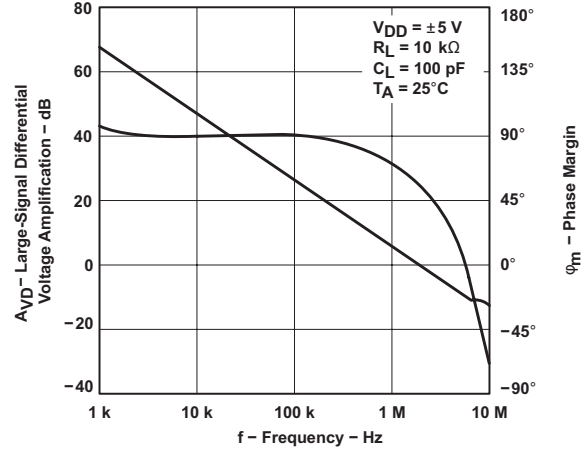

Figure 6-26. Large-Signal Differential Voltage Amplification and Phase Margin vs Frequency

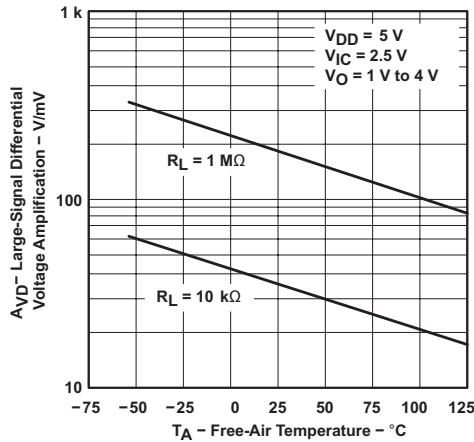

Figure 6-27. Large-Signal Differential Voltage Amplification vs Free-Air Temperature

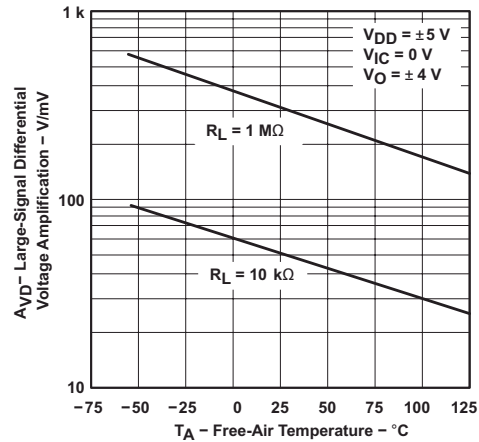

Figure 6-28. Large-Signal Differential Voltage Amplification vs Free-Air Temperature

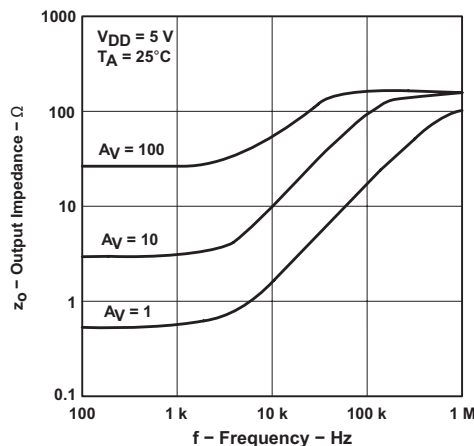

Figure 6-29. Output Impedance vs Frequency

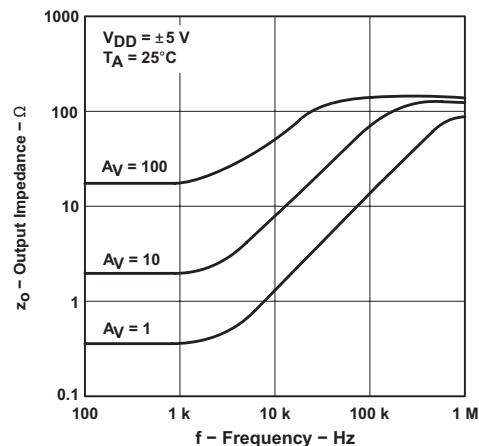

Figure 6-30. Output Impedance vs Frequency

6.9 Typical Characteristics (continued)

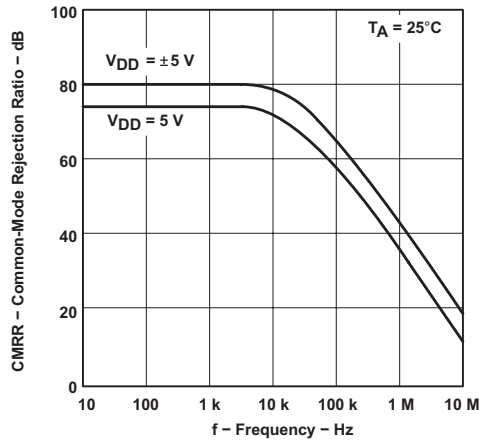

Figure 6-31. Common-Mode Rejection Ratio vs Frequency

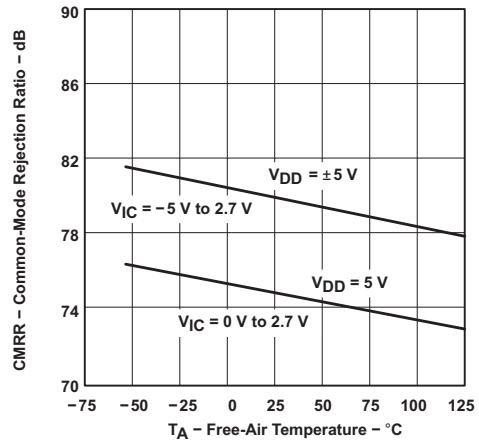

Figure 6-32. Common-Mode Rejection Ratio vs Free-Air Temperature

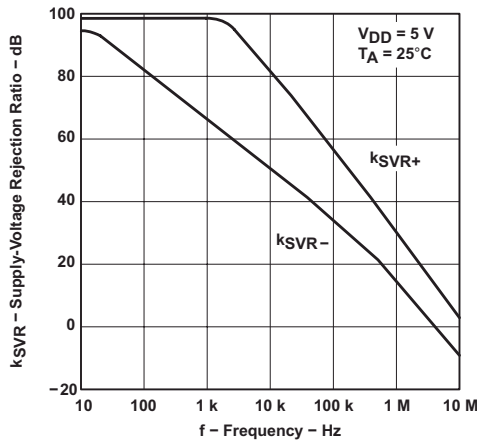

Figure 6-33. Supply-Voltage Rejection Ratio vs Frequency

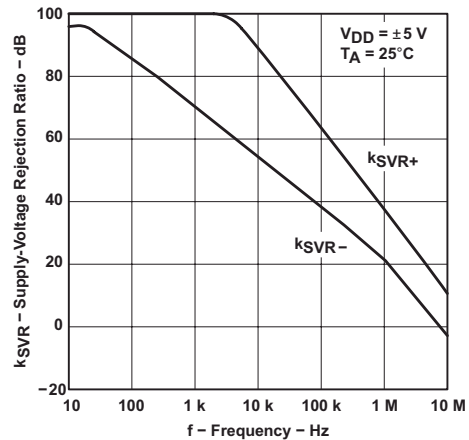

Figure 6-34. Supply-Voltage Rejection Ratio vs Frequency

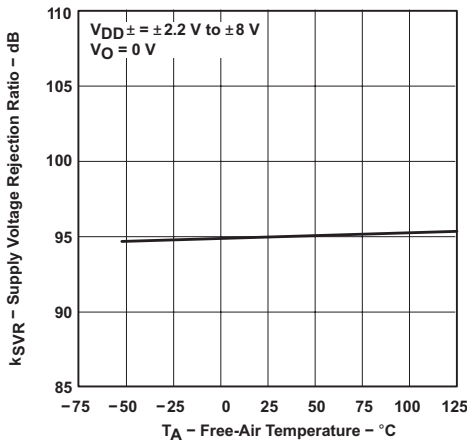

Figure 6-35. Supply-Voltage Rejection Ratio vs Free-Air Temperature

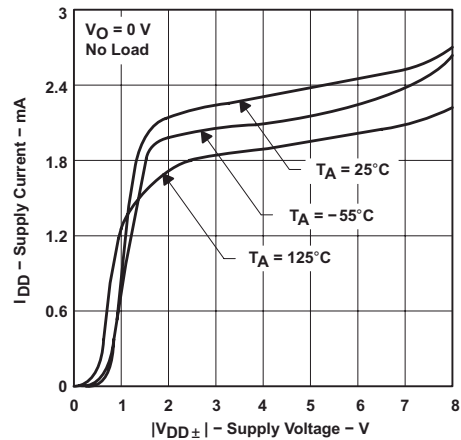

Figure 6-36. TLC2272-Q1 Supply Current vs Supply Voltage

6.9 Typical Characteristics (continued)

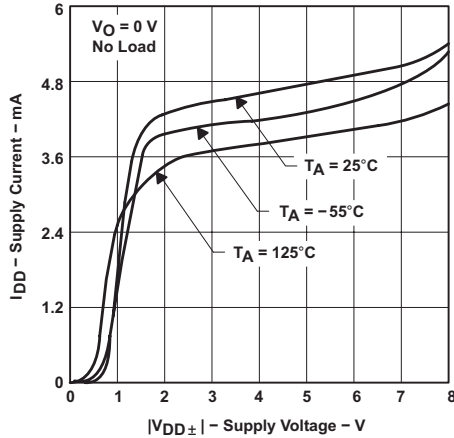

Figure 6-37. TLC2274-Q1 Supply Current vs Supply Voltage

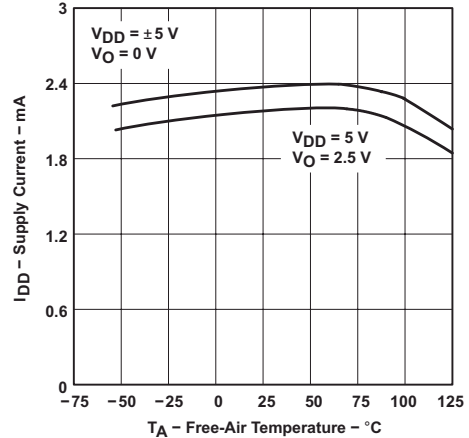

Figure 6-38. TLC2272-Q1 Supply Current vs Free-Air Temperature

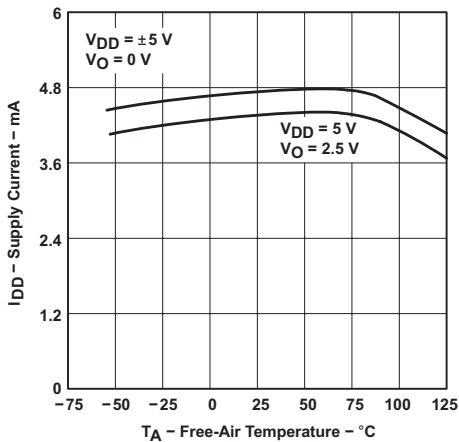

Figure 6-39. TLC2274-Q1 Supply Current vs Free-Air Temperature

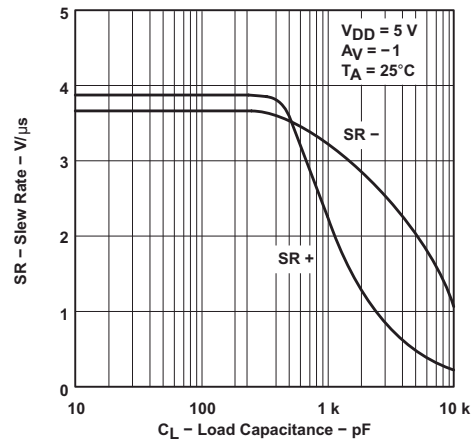

Figure 6-40. Slew Rate vs Load Capacitance

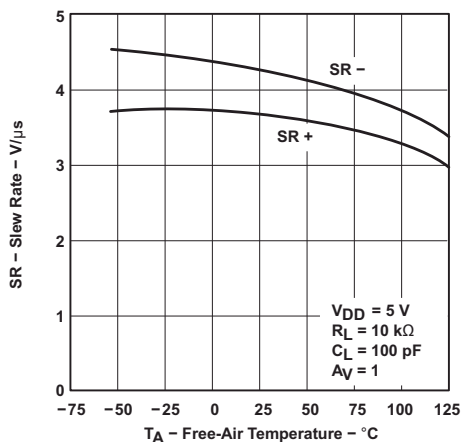

Figure 6-41. Slew Rate vs Free-Air Temperature

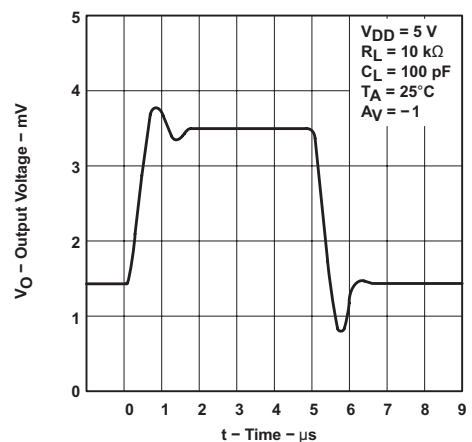

Figure 6-42. Inverting Large-Signal Pulse Response

6.9 Typical Characteristics (continued)

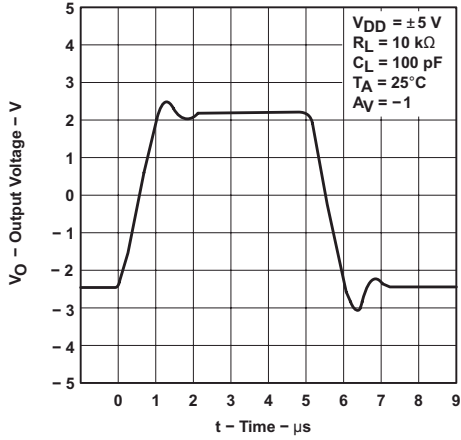

Figure 6-43. Inverting Large-Signal Pulse Response

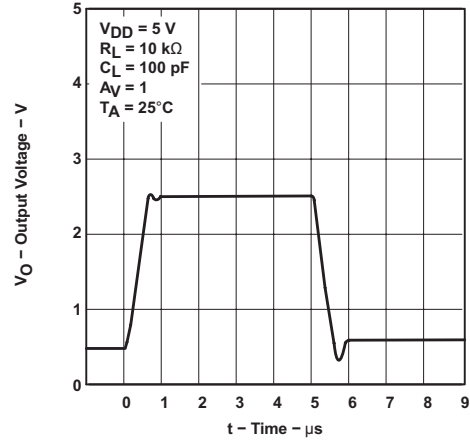

Figure 6-44. Voltage-Follower Large-Signal Pulse Response

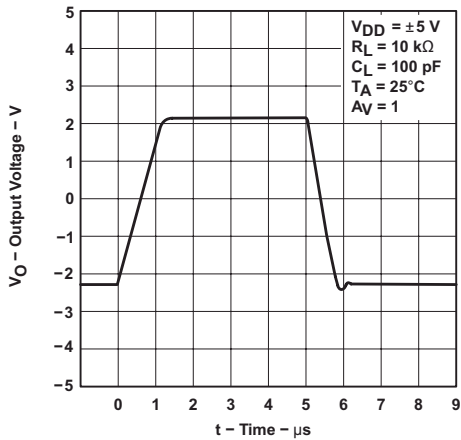

Figure 6-45. Voltage-Follower Large-Signal Pulse Response

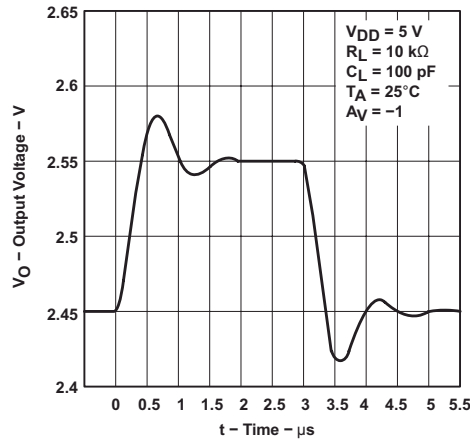

Figure 6-46. Inverting Small-Signal Pulse Response

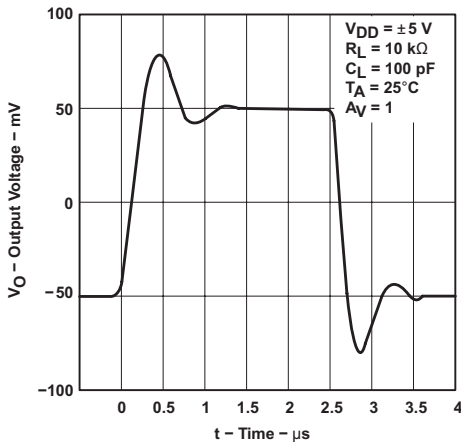

Figure 6-47. Inverting Small-Signal Pulse Response

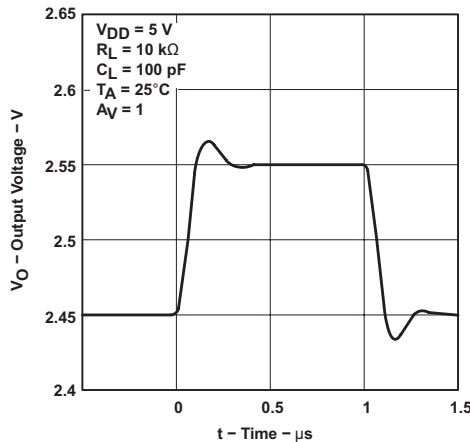

Figure 6-48. Voltage-Follower Small-Signal Pulse Response

6.9 Typical Characteristics (continued)

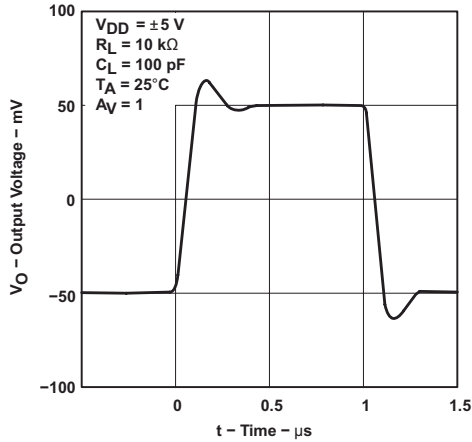

Figure 6-49. Voltage-Follower Small-Signal Pulse Response

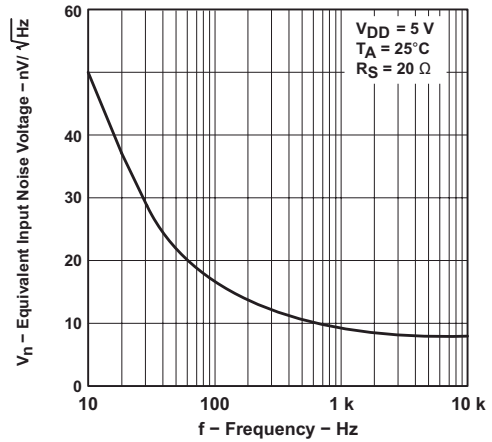

Figure 6-50. Equivalent Input Noise Voltage vs Frequency

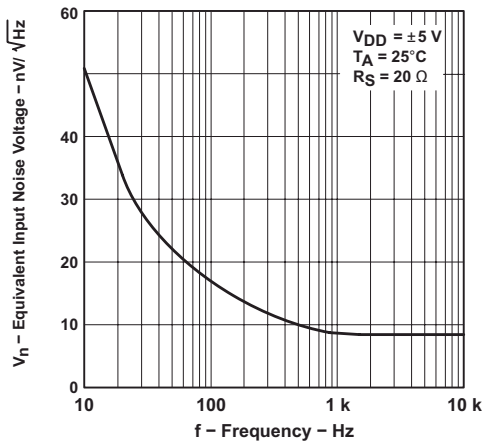

Figure 6-51. Equivalent Input Noise Voltage vs Frequency

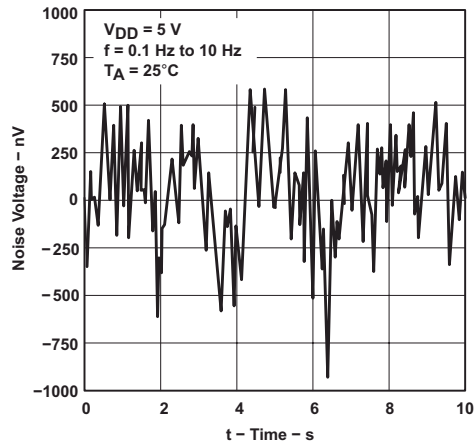

Figure 6-52. Noise Voltage Over a 10 Second Period

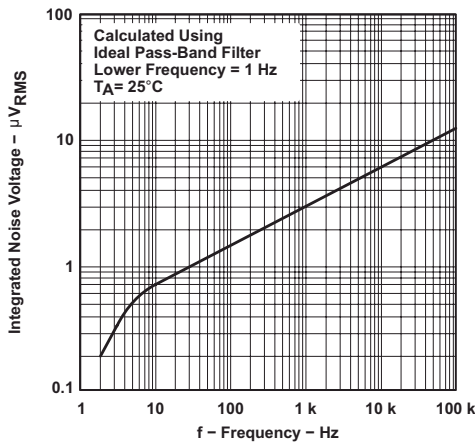

Figure 6-53. Integrated Noise Voltage vs Frequency

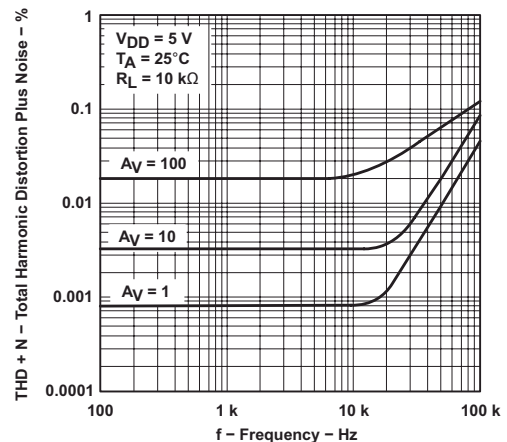

Figure 6-54. Total Harmonic Distortion + Noise vs Frequency

6.9 Typical Characteristics (continued)

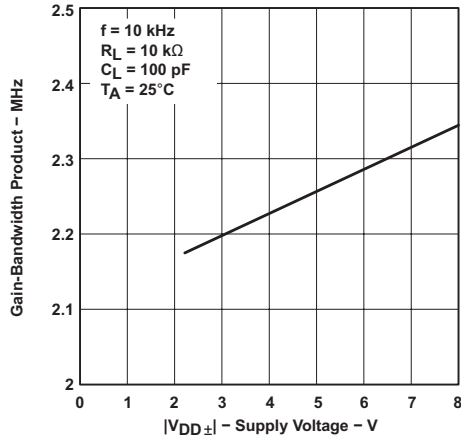

Figure 6-55. Gain-Bandwidth Product vs Supply Voltage

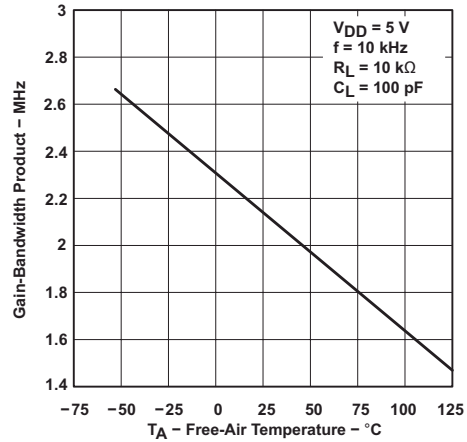

Figure 6-56. Gain-Bandwidth Product vs Free-Air Temperature

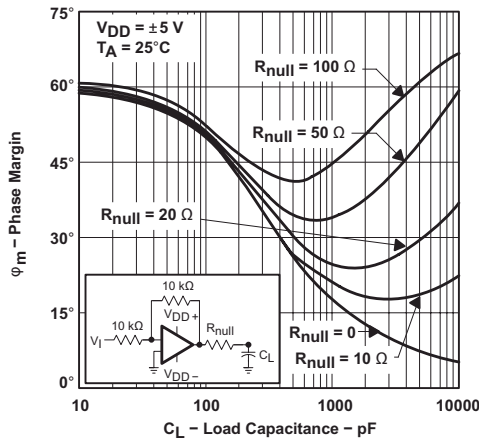

Figure 6-57. Phase Margin vs Load Capacitance

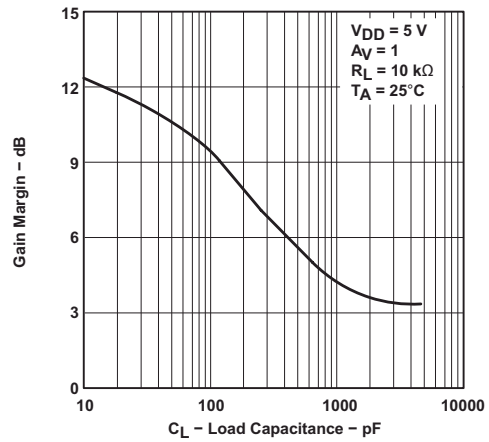

Figure 6-58. Gain Margin vs Load Capacitance

7 Detailed Description

7.1 Overview

The TLC227x-Q1 devices are a rail-to-rail output operational amplifiers. These devices operate from a 4.4-V to 16-V single supply and a ± 2.2 -V ± 8 -V dual supply, are unity-gain stable, and are an excellent choice for a wide range of general-purpose applications.

7.2 Functional Block Diagram

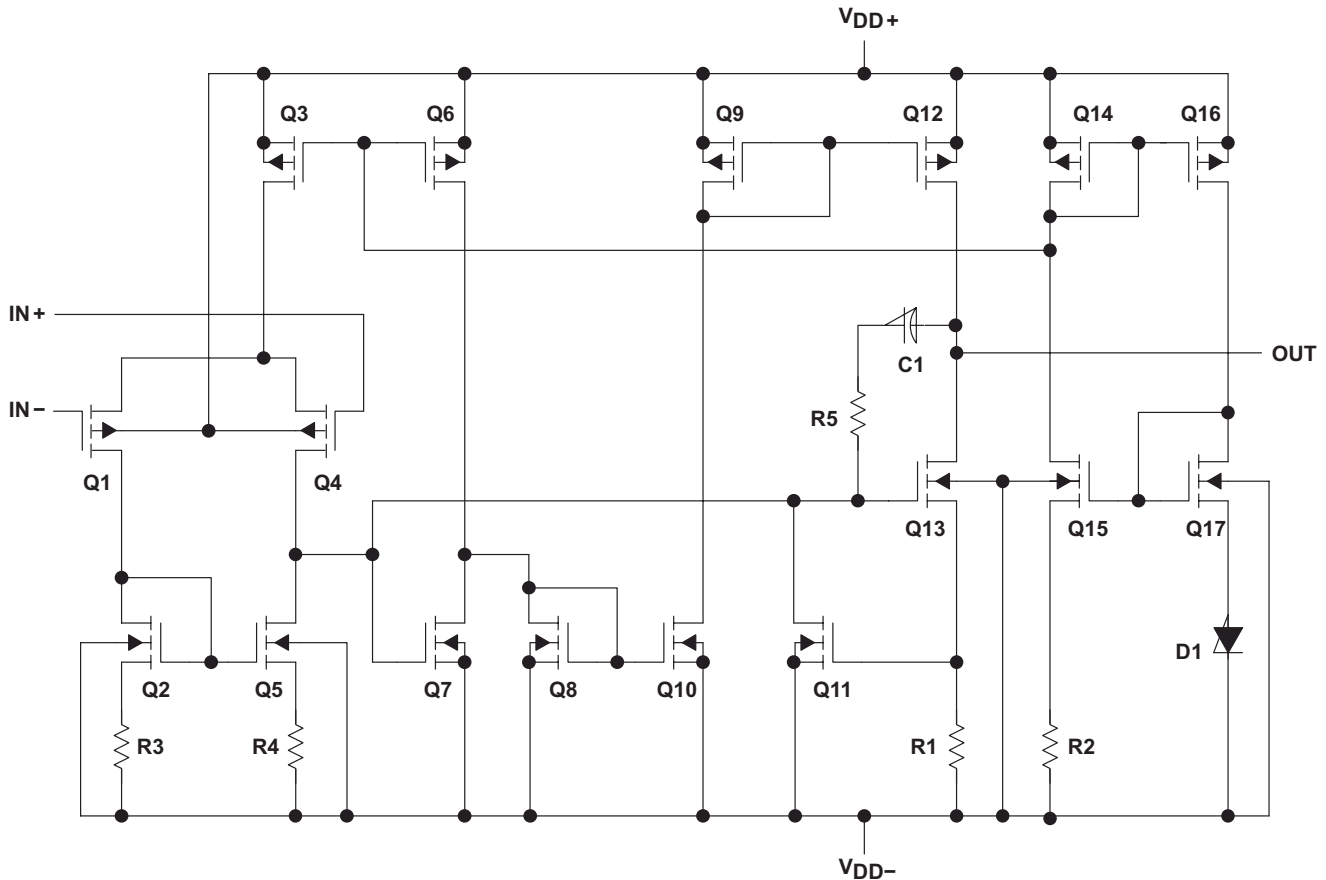

Table 7-1. Actual Device Component Count⁽¹⁾

COMPONENT	TLC2272-Q1	TLC2274-Q1
Transistors	38	76
Resistors	26	52
Diodes	9	18
Capacitors	3	6

(1) Includes both amplifiers and all ESD, bias, and trim circuitry.

7.3 Feature Description

The TLC227x-Q1 family features 2-MHz bandwidth and voltage noise of $9 \text{ nV}/\sqrt{\text{Hz}}$ with performance rated from 4.4 V to 16 V across an automotive temperature range (-40°C to $+125^\circ\text{C}$). LinMOS is a great choice for a wide range of audio, automotive, industrial, and instrumentation applications.

7.4 Device Functional Modes

The TLC227x-Q1 family of devices is powered on when the supply is connected. The device can operate with single or dual supply, depending on the application. The device is in full performance after the supply is greater than the recommended value.

8 Application and Implementation

Note

Information in the following applications sections is not part of the TI component specification, and TI does not warrant its accuracy or completeness. TI's customers are responsible for determining suitability of components for their purposes, as well as validating and testing their design implementation to confirm system functionality.

8.1 Application Information

8.1.1 Macromodel Information

Macromodel information provided was derived using MicroSim Parts, the model generation software used with PSpice®. The Boyle macromodel (see also [Section 9.2.1](#)) and subcircuit in [Figure 8-1](#) were generated using the TLC227x typical electrical and operating characteristics at $T_A = 25^\circ\text{C}$. Using this information, output simulations of the following key parameters can be generated to a tolerance of 20% (in most cases):

- Maximum positive output voltage swing
- Maximum negative output voltage swing
- Slew rate
- Quiescent power dissipation
- Input bias current
- Open-loop voltage amplification
- Unity gain frequency
- Common-mode rejection ratio
- Phase margin
- DC output resistance
- AC output resistance
- Short-circuit output current limit

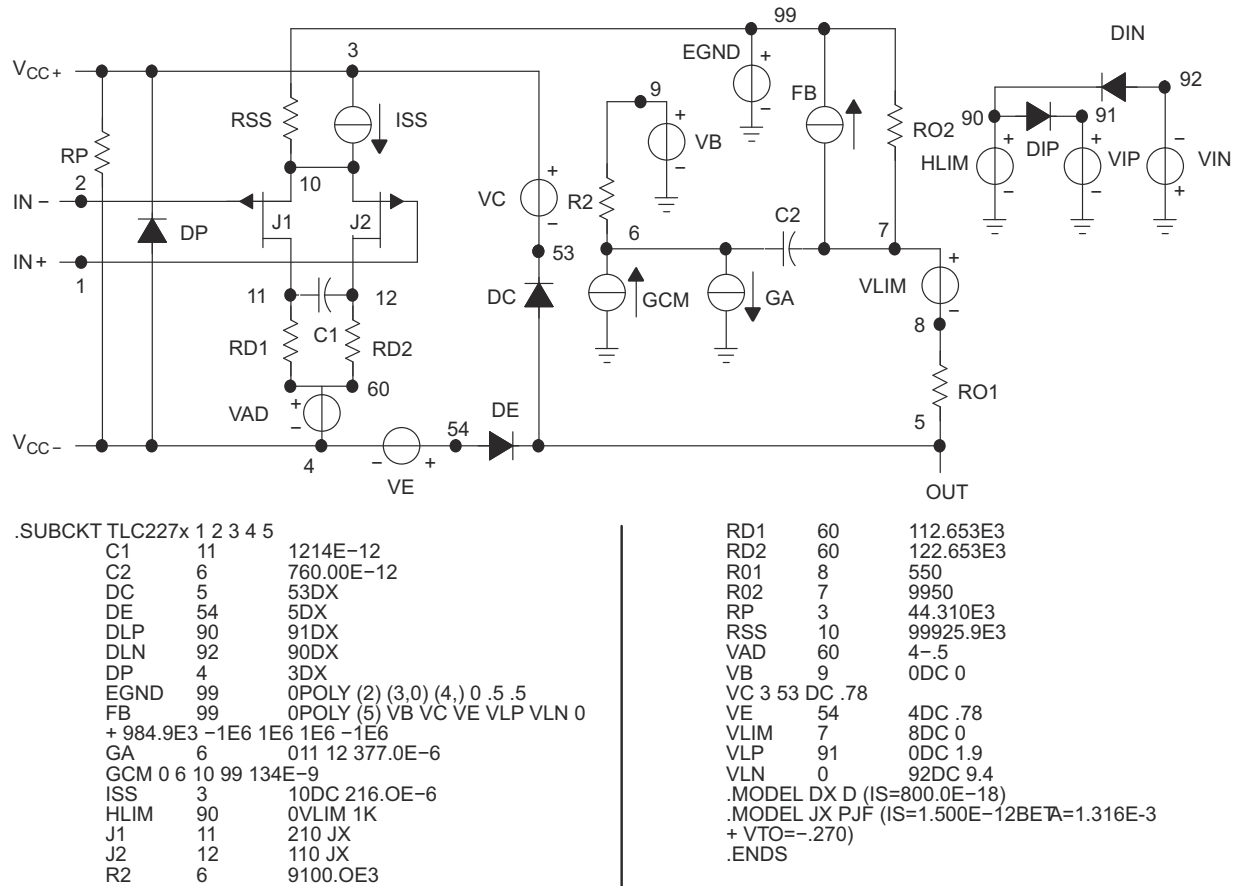

Figure 8-1. Boyle Macromodels and Subcircuit

8.2 Typical Application

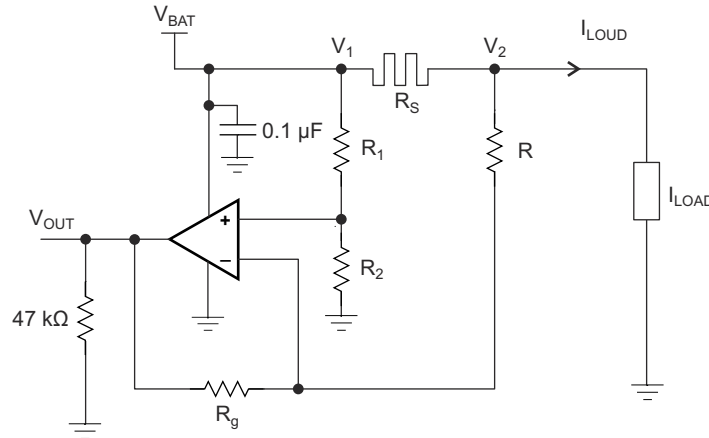

Figure 8-2. High-Side Current Monitor Equivalent Schematic (Each Amplifier)

8.2.1 Design Requirements

For this design example, use these parameters listed in [Table 8-1](#) as the input parameters.

Table 8-1. Design Parameters

PARAMETER		VALUE
V _{BAT}	Battery voltage	12 V
R _{SENSE}	Sense resistor	0.1 Ω
I _{LOAD}	Load current	0 A to 10 A
	Operational amplifier	Set in differential configuration with gain = 10

8.2.2 Detailed Design Procedure

This circuit is designed for measuring the high-side current in automotive body control modules with a 12-V battery or similar applications. The operational amplifier is set as differential with an external resistor network.

8.2.2.1 Differential Amplifier Equations

[Equation 1](#) and [Equation 2](#) are used to calculate V_{OUT}.

$$V_{OUT} = \frac{R_g}{R} \left(\frac{\frac{R}{R_g} - \frac{R_1}{R_2}}{1 + \frac{R_1}{R_2}} \times \frac{V_1 + V_2}{2} + \frac{1 + \frac{1}{2} \left(\frac{R_1}{R_2} + \frac{R}{R_g} \right)}{1 + \frac{R_1}{R_2}} (V_1 - V_2) \right) \quad (1)$$

$$V_{OUT} = \frac{R_g}{R} \left(\frac{\frac{R}{R_g} - \frac{R_1}{R_2}}{1 + \frac{R_1}{R_2}} \times V_{BAT} + \frac{1 + \frac{1}{2} \left(\frac{R_1}{R_2} + \frac{R}{R_g} \right)}{1 + \frac{R_1}{R_2}} \times R_S \times I_{Load} \right) \quad (2)$$

In an ideal case, [Equation 3](#) then calculates R₁ = R and R₂ = R_g, and V_{OUT}:

$$V_{OUT} = \frac{R_g}{R} \times R_S \times I_{Load} \quad (3)$$

However, the resistors have tolerances; therefore, the resistors cannot be perfectly matched.

$$R_1 = R \pm \Delta R_1$$

$$R_2 = R_2 \pm \Delta R_2$$

$$R = R \pm \Delta R$$

$$R_g = R_g \pm \Delta R_g$$

$$\text{Tol} = \frac{\Delta R}{R} \tag{4}$$

Equation 5 shows that by developing the equations and neglecting the second order, the worst case is when the tolerances add up:

$$V_{\text{OUT}} = \pm (4 \text{ Tol}) \frac{R_g}{R + R_g} \times V_{\text{BAT}} + \left(1 \pm 2 \text{ Tol} \left(1 + \frac{2R}{R + R_g} \right) \right) \frac{R_g}{R} \times R_S \times I_{\text{LOAD}} \tag{5}$$

where

- Tol = 0.01 for 1%
- Tol = 0.001 for 0.1%

If the resistors are perfectly matched, then Tol = 0 and Equation 6 calculates V_{OUT} :

$$V_{\text{OUT}} = \frac{R_g}{R} \times R_S \times I_{\text{LOAD}} \tag{6}$$

The highest error is from the common mode:

$$4 (\text{Tol}) \frac{R_g}{R + R_g} \times V_{\text{BAT}} \tag{7}$$

Gain of 10, $R_g / R = 10$, and Tol = 1%:

$$\text{Common mode error} = ((4 \times 0.01) / 1.1) \times 12 \text{ V} = 0.436 \text{ V}$$

Gain of 10 and Tol = 0.1%:

$$\text{Common mode error} = 43.6 \text{ mV}$$

The resistors were chosen from 2% batches.

R_1 and R 12 k Ω

R_2 and R_g 120 k Ω

$$\text{Ideal Gain} = 120 / 12 = 10$$

The measured value of the resistors:

$$R_1 = 11.835 \text{ k}\Omega$$

$$R = 11.85 \text{ k}\Omega$$

$$R_2 = 117.92 \text{ k}\Omega$$

$$R_g = 118.07 \text{ k}\Omega$$

8.2.3 Application Curves

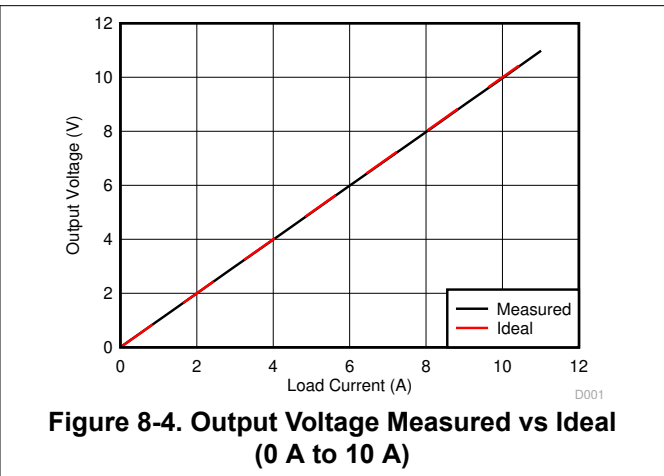
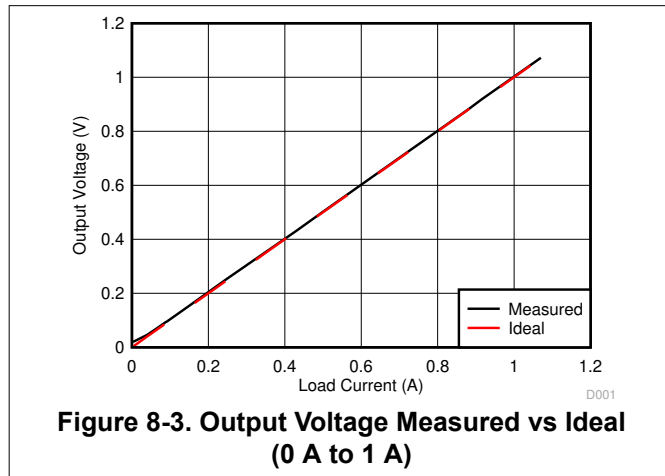

8.3 Power Supply Recommendations

Supply voltage is 4.4 V to 16 V for single supply and ± 2.2 V to ± 8 V for dual. In the high-side sensing application, the supply is connected to a 12-V battery.

8.4 Layout

8.4.1 Layout Guidelines

The TLC227x-Q1 is a wideband amplifier. To realize the full operational performance of the device, good high frequency printed-circuit-board (PCB) layout practices are required. Low-loss 0.1- μ F bypass capacitors must be connected between each supply pin and ground as close to the device as possible. The bypass capacitor traces must be designed for minimum inductance.

8.4.2 Layout Example

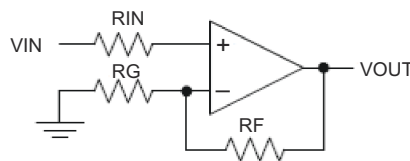

Figure 8-5. Schematic Representation

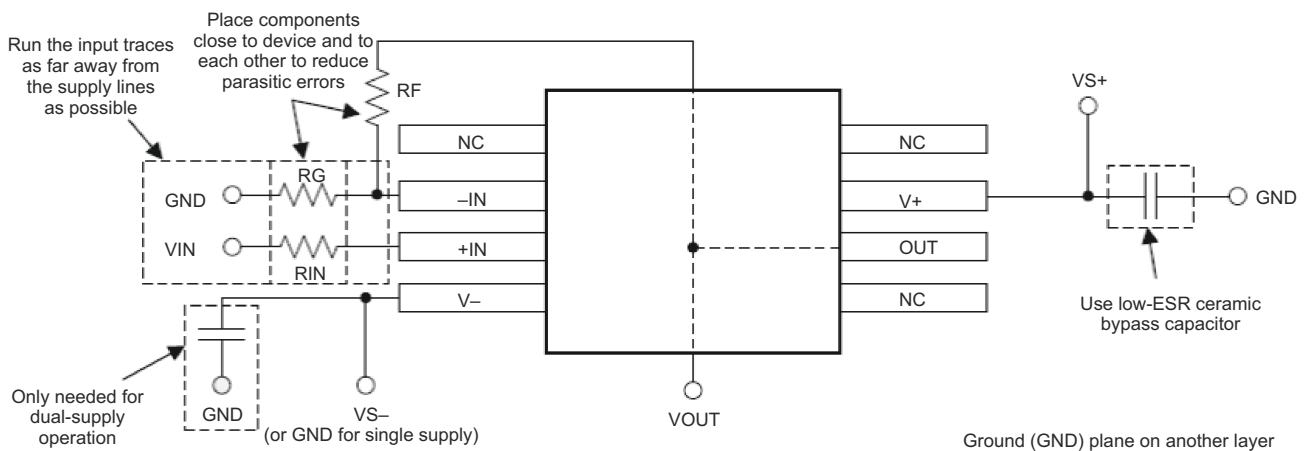

Figure 8-6. Operational Amplifier Board Layout for Noninverting Configuration

9 Device and Documentation Support

9.1 Device Support

9.1.1 Development Support

9.1.1.1 PSpice® for TI

PSpice® for TI is a design and simulation environment that helps evaluate performance of analog circuits. Create subsystem designs and prototype solutions before committing to layout and fabrication, reducing development cost and time to market.

9.1.1.2 TINA-TI™ Simulation Software (Free Download)

TINA-TI™ simulation software is a simple, powerful, and easy-to-use circuit simulation program based on a SPICE engine. TINA-TI simulation software is a free, fully-functional version of the TINA™ software, preloaded with a library of macromodels, in addition to a range of both passive and active models. TINA-TI simulation software provides all the conventional dc, transient, and frequency domain analysis of SPICE, as well as additional design capabilities.

Available as a [free download](#) from the [Design tools and simulation](#) web page, TINA-TI simulation software offers extensive post-processing capability that allows users to format results in a variety of ways. Virtual instruments offer the ability to select input waveforms and probe circuit nodes, voltages, and waveforms, creating a dynamic quick-start tool.

Note

These files require that either the TINA software or TINA-TI software be installed. Download the free TINA-TI simulation software from the [TINA-TI™ software folder](#).

9.2 Documentation Support

9.2.1 Related Documentation

For related documentation see the following:

- G.R. Boyle, D.O. Pederson, B.M. Cohn, J.E. Solomon (Dec. 1974). *Macromodeling of Integrated Circuit Operational Amplifiers*. IEEE Journal of Solid-State Circuits, Volume 9, Issue 6, pages 353–364. Retrieved from <https://ieeexplore.ieee.org/document/1050528>

9.3 Receiving Notification of Documentation Updates

To receive notification of documentation updates, navigate to the device product folder on [ti.com](#). Click on *Subscribe to updates* to register and receive a weekly digest of any product information that has changed. For change details, review the revision history included in any revised document.

9.4 Support Resources

[TI E2E™ support forums](#) are an engineer's go-to source for fast, verified answers and design help — straight from the experts. Search existing answers or ask your own question to get the quick design help you need.

Linked content is provided "AS IS" by the respective contributors. They do not constitute TI specifications and do not necessarily reflect TI's views; see TI's [Terms of Use](#).

9.5 Trademarks

LinCMOS™, TINA-TI™, and TI E2E™ are trademarks of Texas Instruments.

TINA™ is a trademark of DesignSoft, Inc.

PSpice® is a registered trademark of Cadence Design Systems, Inc.

All trademarks are the property of their respective owners.

9.6 Electrostatic Discharge Caution



This integrated circuit can be damaged by ESD. Texas Instruments recommends that all integrated circuits be handled with appropriate precautions. Failure to observe proper handling and installation procedures can cause damage.

ESD damage can range from subtle performance degradation to complete device failure. Precision integrated circuits may be more susceptible to damage because very small parametric changes could cause the device not to meet its published specifications.

9.7 Glossary

[TI Glossary](#) This glossary lists and explains terms, acronyms, and definitions.

10 Mechanical, Packaging, and Orderable Information

The following pages include mechanical, packaging, and orderable information. This information is the most current data available for the designated devices. This data is subject to change without notice and revision of this document. For browser-based versions of this data sheet, refer to the left-hand navigation.

PACKAGING INFORMATION

Orderable Device	Status (1)	Package Type	Package Drawing	Pins	Package Qty	Eco Plan (2)	Lead finish/ Ball material (6)	MSL Peak Temp (3)	Op Temp (°C)	Device Marking (4/5)	Samples
TLC2272AQDRG4Q1	ACTIVE	SOIC	D	8	2500	RoHS & Green	NIPDAU	Level-1-260C-UNLIM	-40 to 125	2272AQ	Samples
TLC2272AQDRQ1	ACTIVE	SOIC	D	8	2500	RoHS & Green	NIPDAU	Level-1-260C-UNLIM	-40 to 125	2272AQ	Samples
TLC2272AQPWRG4Q1	ACTIVE	TSSOP	PW	8	2000	RoHS & Green	NIPDAU	Level-1-260C-UNLIM	-40 to 125	2272AQ	Samples
TLC2272AQPWRQ1	ACTIVE	TSSOP	PW	8	2000	RoHS & Green	NIPDAU	Level-1-260C-UNLIM	-40 to 125	2272AQ	Samples
TLC2272QDRG4Q1	ACTIVE	SOIC	D	8	2500	RoHS & Green	NIPDAU	Level-1-260C-UNLIM	-40 to 125	2272Q1	Samples
TLC2272QDRQ1	ACTIVE	SOIC	D	8	2500	RoHS & Green	NIPDAU	Level-1-260C-UNLIM	-40 to 125	2272Q1	Samples
TLC2272QPWRG4Q1	ACTIVE	TSSOP	PW	8	2000	RoHS & Green	NIPDAU	Level-1-260C-UNLIM	-40 to 125	2272Q1	Samples
TLC2272QPWRQ1	ACTIVE	TSSOP	PW	8	2000	RoHS & Green	NIPDAU	Level-1-260C-UNLIM	-40 to 125	2272Q1	Samples
TLC2274AQDRG4Q1	ACTIVE	SOIC	D	14	2500	RoHS & Green	NIPDAU	Level-1-260C-UNLIM	-40 to 125	2274AQ1	Samples
TLC2274AQDRQ1	ACTIVE	SOIC	D	14	2500	RoHS & Green	NIPDAU	Level-1-260C-UNLIM	-40 to 125	2274AQ1	Samples
TLC2274AQPWRG4Q1	ACTIVE	TSSOP	PW	14	2000	RoHS & Green	NIPDAU	Level-1-260C-UNLIM	-40 to 125	2274AQ1	Samples
TLC2274AQPWRQ1	ACTIVE	TSSOP	PW	14	2000	RoHS & Green	NIPDAU	Level-1-260C-UNLIM	-40 to 125	2274AQ1	Samples
TLC2274QDRG4Q1	ACTIVE	SOIC	D	14	2500	RoHS & Green	NIPDAU	Level-1-260C-UNLIM	-40 to 125	2274Q1	Samples
TLC2274QDRQ1	ACTIVE	SOIC	D	14	2500	RoHS & Green	NIPDAU	Level-1-260C-UNLIM	-40 to 125	2274Q1	Samples
TLC2274QPWRG4Q1	ACTIVE	TSSOP	PW	14	2000	RoHS & Green	NIPDAU	Level-1-260C-UNLIM	-40 to 125	2274Q1	Samples
TLC2274QPWRQ1	ACTIVE	TSSOP	PW	14	2000	RoHS & Green	NIPDAU	Level-1-260C-UNLIM	-40 to 125	2274Q1	Samples

(1) The marketing status values are defined as follows:

ACTIVE: Product device recommended for new designs.

LIFEBUY: TI has announced that the device will be discontinued, and a lifetime-buy period is in effect.

NRND: Not recommended for new designs. Device is in production to support existing customers, but TI does not recommend using this part in a new design.

PREVIEW: Device has been announced but is not in production. Samples may or may not be available.

OBSELETE: TI has discontinued the production of the device.

(2) **RoHS:** TI defines "RoHS" to mean semiconductor products that are compliant with the current EU RoHS requirements for all 10 RoHS substances, including the requirement that RoHS substance do not exceed 0.1% by weight in homogeneous materials. Where designed to be soldered at high temperatures, "RoHS" products are suitable for use in specified lead-free processes. TI may reference these types of products as "Pb-Free".

RoHS Exempt: TI defines "RoHS Exempt" to mean products that contain lead but are compliant with EU RoHS pursuant to a specific EU RoHS exemption.

Green: TI defines "Green" to mean the content of Chlorine (Cl) and Bromine (Br) based flame retardants meet JS709B low halogen requirements of ≤ 1000 ppm threshold. Antimony trioxide based flame retardants must also meet the ≤ 1000 ppm threshold requirement.

(3) MSL, Peak Temp. - The Moisture Sensitivity Level rating according to the JEDEC industry standard classifications, and peak solder temperature.

(4) There may be additional marking, which relates to the logo, the lot trace code information, or the environmental category on the device.

(5) Multiple Device Markings will be inside parentheses. Only one Device Marking contained in parentheses and separated by a "~" will appear on a device. If a line is indented then it is a continuation of the previous line and the two combined represent the entire Device Marking for that device.

(6) Lead finish/Ball material - Orderable Devices may have multiple material finish options. Finish options are separated by a vertical ruled line. Lead finish/Ball material values may wrap to two lines if the finish value exceeds the maximum column width.

Important Information and Disclaimer: The information provided on this page represents TI's knowledge and belief as of the date that it is provided. TI bases its knowledge and belief on information provided by third parties, and makes no representation or warranty as to the accuracy of such information. Efforts are underway to better integrate information from third parties. TI has taken and continues to take reasonable steps to provide representative and accurate information but may not have conducted destructive testing or chemical analysis on incoming materials and chemicals. TI and TI suppliers consider certain information to be proprietary, and thus CAS numbers and other limited information may not be available for release.

In no event shall TI's liability arising out of such information exceed the total purchase price of the TI part(s) at issue in this document sold by TI to Customer on an annual basis.

OTHER QUALIFIED VERSIONS OF TLC2272-Q1, TLC2272A-Q1, TLC2274-Q1, TLC2274A-Q1 :

- Catalog : [TLC2272](#), [TLC2272A](#), [TLC2274](#), [TLC2274A](#)
- Enhanced Product : [TLC2272A-EP](#), [TLC2274-EP](#), [TLC2274A-EP](#)
- Military : [TLC2272M](#), [TLC2272AM](#), [TLC2274M](#), [TLC2274AM](#)

NOTE: Qualified Version Definitions:

- Catalog - TI's standard catalog product
- Enhanced Product - Supports Defense, Aerospace and Medical Applications

- Military - QML certified for Military and Defense Applications

TAPE AND REEL INFORMATION

QUADRANT ASSIGNMENTS FOR PIN 1 ORIENTATION IN TAPE

*All dimensions are nominal

Device	Package Type	Package Drawing	Pins	SPQ	Reel Diameter (mm)	Reel Width W1 (mm)	A0 (mm)	B0 (mm)	K0 (mm)	P1 (mm)	W (mm)	Pin1 Quadrant
TLC2272AQPWRG4Q1	TSSOP	PW	8	2000	330.0	12.4	7.0	3.6	1.6	8.0	12.0	Q1
TLC2272AQPWRQ1	TSSOP	PW	8	2000	330.0	12.4	7.0	3.6	1.6	8.0	12.0	Q1
TLC2272QPWRG4Q1	TSSOP	PW	8	2000	330.0	12.4	7.0	3.6	1.6	8.0	12.0	Q1
TLC2272QPWRQ1	TSSOP	PW	8	2000	330.0	12.4	7.0	3.6	1.6	8.0	12.0	Q1
TLC2274AQPWRG4Q1	TSSOP	PW	14	2000	330.0	12.4	6.9	5.6	1.6	8.0	12.0	Q1
TLC2274AQPWRQ1	TSSOP	PW	14	2000	330.0	12.4	6.9	5.6	1.6	8.0	12.0	Q1
TLC2274QPWRG4Q1	TSSOP	PW	14	2000	330.0	12.4	6.9	5.6	1.6	8.0	12.0	Q1
TLC2274QPWRQ1	TSSOP	PW	14	2000	330.0	12.4	6.9	5.6	1.6	8.0	12.0	Q1

TAPE AND REEL BOX DIMENSIONS

*All dimensions are nominal

Device	Package Type	Package Drawing	Pins	SPQ	Length (mm)	Width (mm)	Height (mm)
TLC2272AQPWRG4Q1	TSSOP	PW	8	2000	356.0	356.0	35.0
TLC2272AQPWRQ1	TSSOP	PW	8	2000	356.0	356.0	35.0
TLC2272QPWRG4Q1	TSSOP	PW	8	2000	356.0	356.0	35.0
TLC2272QPWRQ1	TSSOP	PW	8	2000	356.0	356.0	35.0
TLC2274AQPWRG4Q1	TSSOP	PW	14	2000	356.0	356.0	35.0
TLC2274AQPWRQ1	TSSOP	PW	14	2000	356.0	356.0	35.0
TLC2274QPWRG4Q1	TSSOP	PW	14	2000	356.0	356.0	35.0
TLC2274QPWRQ1	TSSOP	PW	14	2000	356.0	356.0	35.0

D (R-PDSO-G14)

PLASTIC SMALL OUTLINE

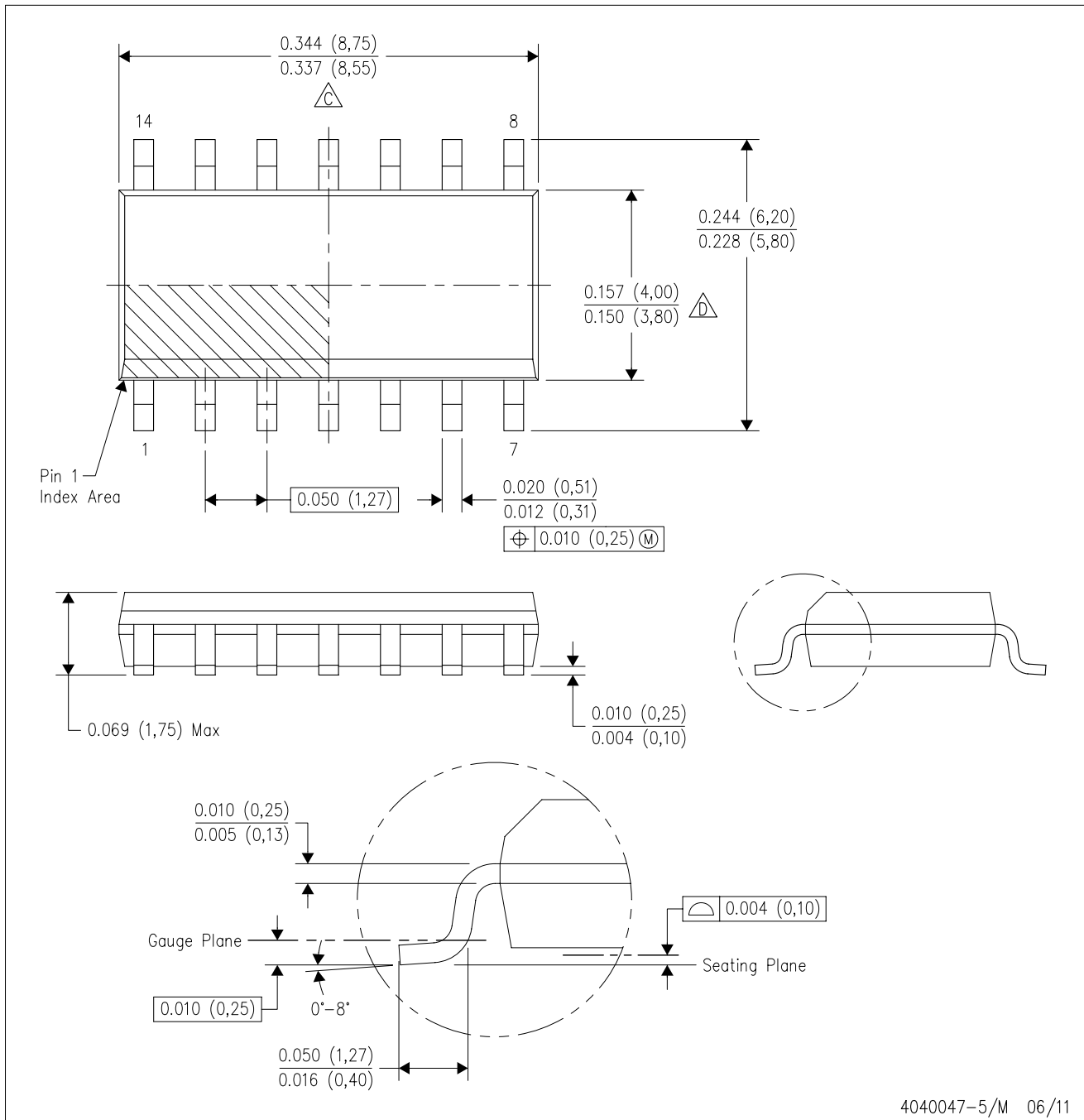

- NOTES:
- A. All linear dimensions are in inches (millimeters).
 - B. This drawing is subject to change without notice.
 - $\triangle C$ Body length does not include mold flash, protrusions, or gate burrs. Mold flash, protrusions, or gate burrs shall not exceed 0.006 (0,15) each side.
 - $\triangle D$ Body width does not include interlead flash. Interlead flash shall not exceed 0.017 (0,43) each side.
 - E. Reference JEDEC MS-012 variation AB.

D (R-PDSO-G14)

PLASTIC SMALL OUTLINE





- NOTES:
- All linear dimensions are in millimeters.
 - This drawing is subject to change without notice.
 - Publication IPC-7351 is recommended for alternate designs.
 - Laser cutting apertures with trapezoidal walls and also rounding corners will offer better paste release. Customers should contact their board assembly site for stencil design recommendations. Refer to IPC-7525 for other stencil recommendations.
 - Customers should contact their board fabrication site for solder mask tolerances between and around signal pads.

PW (R-PDSO-G14)

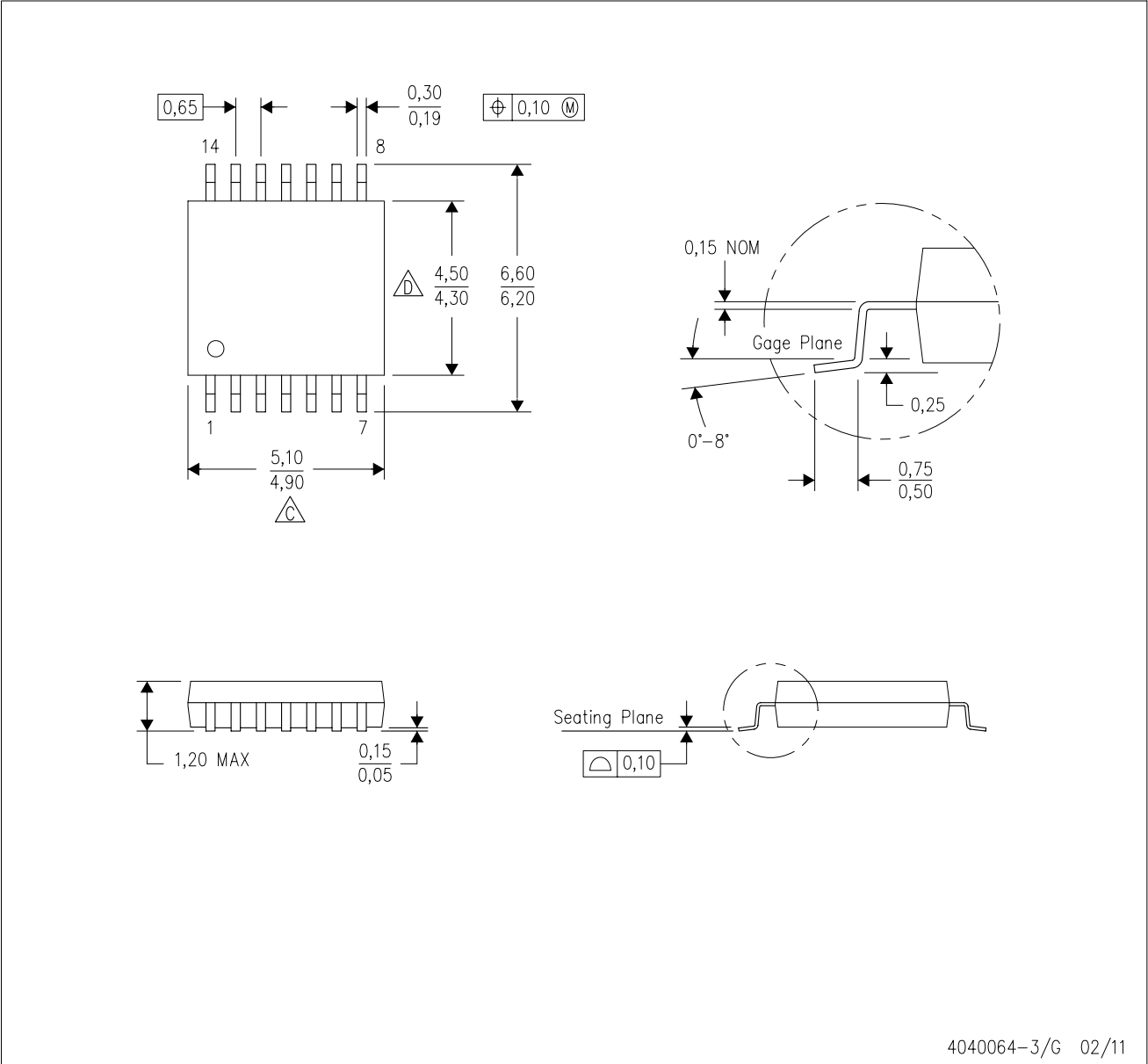
PLASTIC SMALL OUTLINE



4040064-3/G 02/11

- NOTES:
- A. All linear dimensions are in millimeters. Dimensioning and tolerancing per ASME Y14.5M-1994.
 - B. This drawing is subject to change without notice.
 -  Body length does not include mold flash, protrusions, or gate burrs. Mold flash, protrusions, or gate burrs shall not exceed 0,15 each side.
 -  Body width does not include interlead flash. Interlead flash shall not exceed 0,25 each side.
 - E. Falls within JEDEC MO-153

PW (R-PDSO-G14)

PLASTIC SMALL OUTLINE

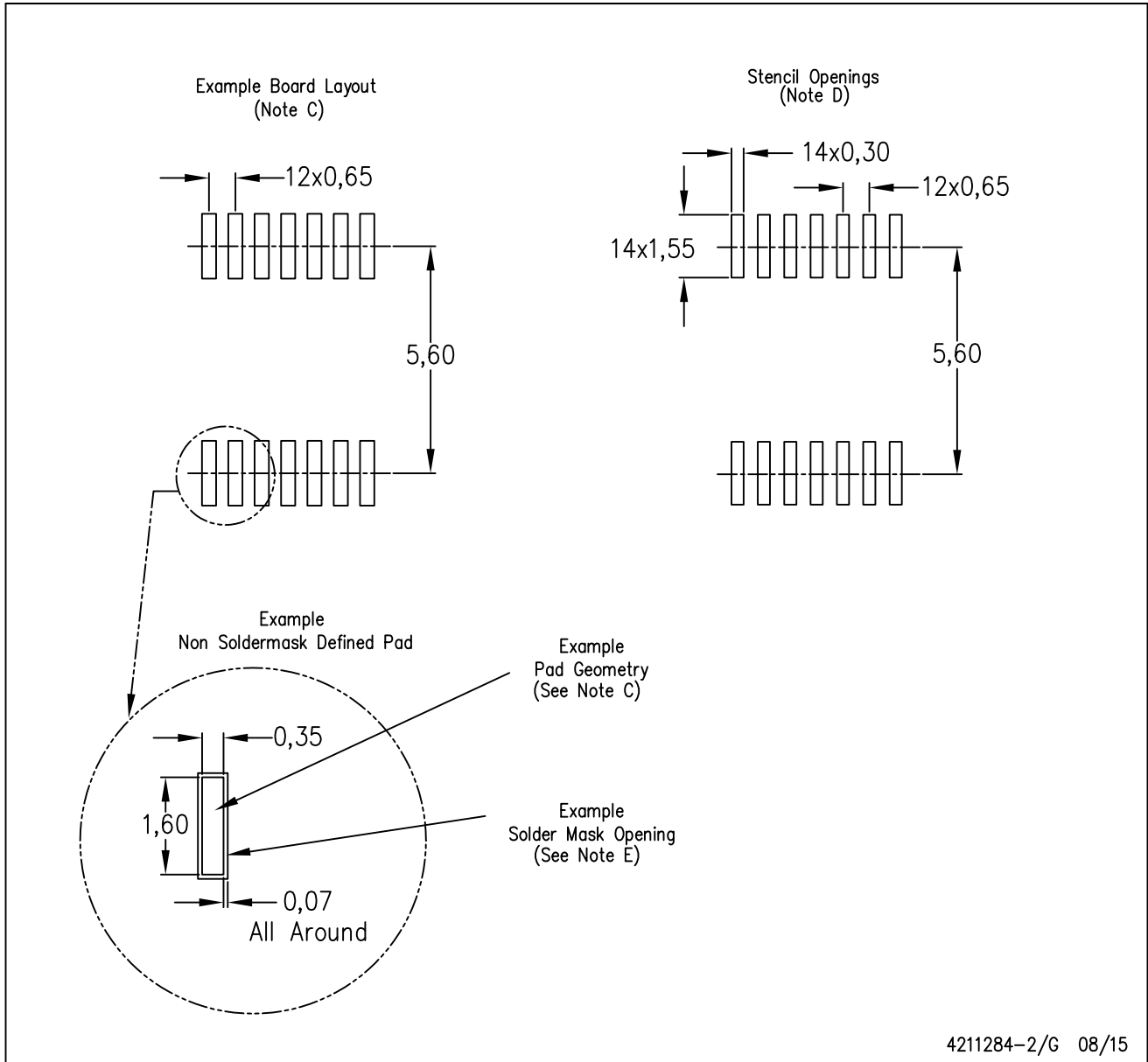

4211284-2/G 08/15

- NOTES:
- A. All linear dimensions are in millimeters.
 - B. This drawing is subject to change without notice.
 - C. Publication IPC-7351 is recommended for alternate designs.
 - D. Laser cutting apertures with trapezoidal walls and also rounding corners will offer better paste release. Customers should contact their board assembly site for stencil design recommendations. Refer to IPC-7525 for other stencil recommendations.
 - E. Customers should contact their board fabrication site for solder mask tolerances between and around signal pads.



D0008A

PACKAGE OUTLINE

SOIC - 1.75 mm max height

SMALL OUTLINE INTEGRATED CIRCUIT



4214825/C 02/2019

NOTES:

- Linear dimensions are in inches [millimeters]. Dimensions in parenthesis are for reference only. Controlling dimensions are in inches. Dimensioning and tolerancing per ASME Y14.5M.
- This drawing is subject to change without notice.
- This dimension does not include mold flash, protrusions, or gate burrs. Mold flash, protrusions, or gate burrs shall not exceed $.006$ [0.15] per side.
- This dimension does not include interlead flash.
- Reference JEDEC registration MS-012, variation AA.

EXAMPLE BOARD LAYOUT

D0008A

SOIC - 1.75 mm max height

SMALL OUTLINE INTEGRATED CIRCUIT



LAND PATTERN EXAMPLE
 EXPOSED METAL SHOWN
 SCALE:8X



SOLDER MASK DETAILS

4214825/C 02/2019

NOTES: (continued)

- 6. Publication IPC-7351 may have alternate designs.
- 7. Solder mask tolerances between and around signal pads can vary based on board fabrication site.

EXAMPLE STENCIL DESIGN

D0008A

SOIC - 1.75 mm max height

SMALL OUTLINE INTEGRATED CIRCUIT



SOLDER PASTE EXAMPLE
BASED ON .005 INCH [0.125 MM] THICK STENCIL
SCALE:8X

4214825/C 02/2019

NOTES: (continued)

8. Laser cutting apertures with trapezoidal walls and rounded corners may offer better paste release. IPC-7525 may have alternate design recommendations.
9. Board assembly site may have different recommendations for stencil design.

PW0008A



PACKAGE OUTLINE
TSSOP - 1.2 mm max height

SMALL OUTLINE PACKAGE



4221848/A 02/2015

NOTES:

1. All linear dimensions are in millimeters. Any dimensions in parenthesis are for reference only. Dimensioning and tolerancing per ASME Y14.5M.
2. This drawing is subject to change without notice.
3. This dimension does not include mold flash, protrusions, or gate burrs. Mold flash, protrusions, or gate burrs shall not exceed 0.15 mm per side.
4. This dimension does not include interlead flash. Interlead flash shall not exceed 0.25 mm per side.
5. Reference JEDEC registration MO-153, variation AA.

EXAMPLE BOARD LAYOUT

PW0008A

TSSOP - 1.2 mm max height

SMALL OUTLINE PACKAGE



LAND PATTERN EXAMPLE
SCALE:10X



SOLDER MASK DETAILS
NOT TO SCALE

4221848/A 02/2015

NOTES: (continued)

- 6. Publication IPC-7351 may have alternate designs.
- 7. Solder mask tolerances between and around signal pads can vary based on board fabrication site.

EXAMPLE STENCIL DESIGN

PW0008A

TSSOP - 1.2 mm max height

SMALL OUTLINE PACKAGE



SOLDER PASTE EXAMPLE
BASED ON 0.125 mm THICK STENCIL
SCALE:10X

4221848/A 02/2015

NOTES: (continued)

8. Laser cutting apertures with trapezoidal walls and rounded corners may offer better paste release. IPC-7525 may have alternate design recommendations.
9. Board assembly site may have different recommendations for stencil design.

IMPORTANT NOTICE AND DISCLAIMER

TI PROVIDES TECHNICAL AND RELIABILITY DATA (INCLUDING DATA SHEETS), DESIGN RESOURCES (INCLUDING REFERENCE DESIGNS), APPLICATION OR OTHER DESIGN ADVICE, WEB TOOLS, SAFETY INFORMATION, AND OTHER RESOURCES "AS IS" AND WITH ALL FAULTS, AND DISCLAIMS ALL WARRANTIES, EXPRESS AND IMPLIED, INCLUDING WITHOUT LIMITATION ANY IMPLIED WARRANTIES OF MERCHANTABILITY, FITNESS FOR A PARTICULAR PURPOSE OR NON-INFRINGEMENT OF THIRD PARTY INTELLECTUAL PROPERTY RIGHTS.

These resources are intended for skilled developers designing with TI products. You are solely responsible for (1) selecting the appropriate TI products for your application, (2) designing, validating and testing your application, and (3) ensuring your application meets applicable standards, and any other safety, security, regulatory or other requirements.

These resources are subject to change without notice. TI grants you permission to use these resources only for development of an application that uses the TI products described in the resource. Other reproduction and display of these resources is prohibited. No license is granted to any other TI intellectual property right or to any third party intellectual property right. TI disclaims responsibility for, and you will fully indemnify TI and its representatives against, any claims, damages, costs, losses, and liabilities arising out of your use of these resources.

TI's products are provided subject to [TI's Terms of Sale](#) or other applicable terms available either on ti.com or provided in conjunction with such TI products. TI's provision of these resources does not expand or otherwise alter TI's applicable warranties or warranty disclaimers for TI products.

TI objects to and rejects any additional or different terms you may have proposed.

Mailing Address: Texas Instruments, Post Office Box 655303, Dallas, Texas 75265
Copyright © 2022, Texas Instruments Incorporated