

OPA207 Low-Power, High-Precision, Low-Noise, Rail-to-Rail Output Operational Amplifier

1 Features

- Ultra-low offset voltage: 150 μV (maximum)
- Ultra-low drift: $\pm 1 \mu\text{V}/^\circ\text{C}$ (maximum)
- Gain bandwidth: 1 MHz (typical)
- Slew rate: 3.6 $\text{V}/\mu\text{s}$ (typical)
- High open-loop gain: 130 dB (minimum)
- High common-mode rejection: 115 dB (minimum)
- High power-supply rejection: 5 $\mu\text{V}/\text{V}$ (maximum)
- Low bias current: 2.8 nA (maximum)
- Wide supply range: $\pm 2.25 \text{ V}$ to $\pm 18 \text{ V}$
- Low quiescent current: 375 μA (maximum)
- Replaces OP-07, OP-77, and OP-177

2 Applications

- [Analog input module](#)
- [Battery test](#)
- [Data acquisition \(DAQ\)](#)
- [Pressure transmitter](#)
- [Temperature transmitter](#)

3 Description

The OPA207 precision operational amplifier (op amp) replaces the industry standard OP-07, OP-77 and OP-177 amplifiers. The OPA207 offers improved noise, wider output voltage swing, and is twice as fast with half the quiescent current of the industry standard alternatives. Features include ultra-low input offset voltage and drift, low input bias current, high common-mode rejection ratio, and high power-supply rejection ratio.

The OPA207 op amp operates over a wide power-supply-voltage range, from $\pm 2.25 \text{ V}$ to $\pm 18 \text{ V}$, with excellent performance. High performance is maintained as the amplifiers swing to their specified limits.

The OPA207 operational amplifier is easy to use and free from phase inversion and the overload problems found in some other operational amplifiers. The OPA207 is stable in unity gain and provide excellent dynamic behavior over a wide range of load conditions.

Device Information⁽¹⁾

PART NUMBER	PACKAGE	BODY SIZE (NOM)
OPA207	SOIC (8)	4.90 mm x 3.91 mm
	VSSOP (8)	3.00 mm x 3.00 mm
	SOT-23 (5)	2.90 mm x 1.60 mm

(1) For all available packages, see the package option addendum at the end of the data sheet.

Ultra-Low 0.1-Hz to 10-Hz Noise

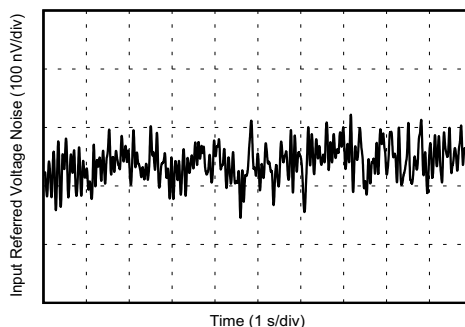

Table of Contents

1 Features	1	7.4 Device Functional Modes.....	19
2 Applications	1	8 Application and Implementation	20
3 Description	1	8.1 Application Information.....	20
4 Revision History	2	8.2 Typical Applications	20
5 Pin Configuration and Functions	3	9 Power Supply Recommendations	23
6 Specifications	4	10 Layout	23
6.1 Absolute Maximum Ratings	4	10.1 Layout Guidelines	23
6.2 ESD Ratings	4	10.2 Layout Example	24
6.3 Recommended Operating Conditions.....	4	11 Device and Documentation Support	25
6.4 Thermal Information	4	11.1 Device Support	25
6.5 Electrical Characteristics.....	5	11.2 Documentation Support	25
6.6 Typical Characteristics.....	7	11.3 Receiving Notification of Documentation Updates	25
7 Detailed Description	13	11.4 Support Resources	25
7.1 Overview	13	11.5 Trademarks	26
7.2 Functional Block Diagram	13	11.6 Electrostatic Discharge Caution.....	26
7.3 Feature Description.....	13	12 Mechanical, Packaging, and Orderable Information	26

4 Revision History

NOTE: Page numbers for previous revisions may differ from page numbers in the current version.

Changes from Revision C (March 2019) to Revision D	Page
• Changed SOT-23 (DBV) package from preview to production data (active)	1
• Added specifications for new DBV package.....	4

Changes from Revision B (March 2019) to Revision C	Page
• Added input offset voltage specification for OPA207DGK	5
• Added input offset voltage drift specification for OPA207DGK	5

Changes from Revision A (December 2018) to Revision B	Page
• Added content for first release of production-data data sheet for VSSOP (DGK) package.....	1

Changes from Original (December 2017) to Revision A	Page
• Added content re: 5-pin SOT-23 package for Advance Information	1

5 Pin Configuration and Functions

**D and DGK Packages
8-Pin SOIC and 8-Pin VSSOP
Top View**

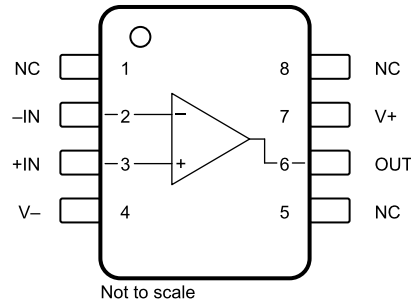

**DBV Package
5-Pin SOT-23
Top View**

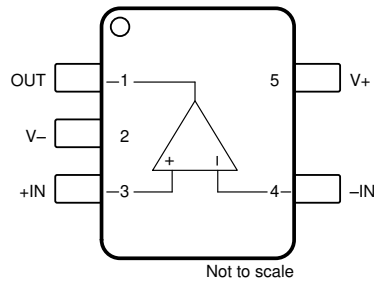

Pin Functions

NAME	PIN NO.		I/O	DESCRIPTION
	D (SOIC), DGK(VSSOP)	DBV (SOT-23)		
-IN	2	4	I	Inverting input
+IN	3	3	I	Non-inverting input
NC	1, 5, 8	—	—	No internal connection (can be left floating or connected to ground)
OUT	6	1	O	Output
V-	4	2	—	Negative (lowest) power supply
V+	7	5	—	Positive (highest) power supply

6 Specifications

6.1 Absolute Maximum Ratings

over operating free-air temperature range (unless otherwise noted) ⁽¹⁾

	MIN	MAX	UNIT
Supply voltage, $V_S = (V+) - (V-)$		36	V
Input voltage - Common-mode ⁽²⁾	(V-) -0.7	(V+) +0.7	V
Input voltage - Differential	-1	1	V
Output short-circuit ⁽³⁾	Continuous		
Operating temperature	-55	125	°C
Junction temperature		150	°C
Storage temperature, T_{stg}	-65	150	°C

- (1) Stresses beyond those listed under *Absolute Maximum Ratings* may cause permanent damage to the device. These are stress ratings only, which do not imply functional operation of the device at these or any other conditions beyond those indicated under *Recommended Operating Conditions*. Exposure to absolute-maximum-rated conditions for extended periods may affect device reliability.
- (2) Input current must be limited to 10 mA.
- (3) Short circuit to ground, one amplifier per package.

6.2 ESD Ratings

		VALUE	UNIT
$V_{(ESD)}$	Electrostatic discharge	Human-body model (HBM), per ANSI/ESDA/JEDEC JS-001 ⁽¹⁾	2000
		Charged-device model (CDM), per JEDEC specification JESD22-C101 ⁽²⁾	1000

- (1) JEDEC document JEP155 states that 500-V HBM allows safe manufacturing with a standard ESD control process.
- (2) JEDEC document JEP157 states that 250-V CDM allows safe manufacturing with a standard ESD control process.

6.3 Recommended Operating Conditions

over operating free-air temperature range (unless otherwise noted)

		MIN	NOM	MAX	UNIT
Supply voltage, $V_S = (V+) - (V-)$	Single Supply	4.5	30	36	V
	Dual Supply	±2.25	±15	±18	V
Specified temperature		-40		125	°C

6.4 Thermal Information

THERMAL METRIC ⁽¹⁾		OPA207			UNIT
		DGK (VSSOP)	D (SOIC)	DBV (SOT-23)	
		8 PINS	8 PINS	8 PINS	
$R_{\theta JA}$	Junction-to-ambient thermal resistance	176.7	121.5	166.3	°C/W
$R_{\theta JC(top)}$	Junction-to-case (top) thermal resistance	63.9	64.3	116.9	°C/W
$R_{\theta JB}$	Junction-to-board thermal resistance	99.4	65.0	63.2	°C/W
Ψ_{JT}	Junction-to-top characterization parameter	8.8	18.2	45	°C/W
Ψ_{JB}	Junction-to-board characterization parameter	97.6	64.3	62.9	°C/W

- (1) For more information about traditional and new thermal metrics, see the [Semiconductor and IC Package ThermalMetrics](#) application report.

6.5 Electrical Characteristics

at $V_S = \pm 15\text{ V}$, $T_A = 25^\circ\text{C}$, $R_L = 2\text{ k}\Omega$ connected to $V_S / 2$, $V_{CM} = V_S / 2$, and $V_{OUT} = V_S / 2$ (unless otherwise noted)

PARAMETER		TEST CONDITIONS	MIN	TYP	MAX	UNIT
OFFSET VOLTAGE						
V_{OS}	Input offset voltage OPA207D			15	± 100	μV
		$T_A = -40^\circ\text{C}$ to 85°C			± 150	
		$T_A = -40^\circ\text{C}$ to 125°C			± 200	
	Input offset voltage OPA207DGK			15	± 125	
		$T_A = 0^\circ\text{C}$ to 85°C			± 170	
		$T_A = -40^\circ\text{C}$ to 125°C			± 225	
Input offset voltage OPA207DBV			15	± 130		
	$T_A = 0^\circ\text{C}$ to 85°C			± 170		
	$T_A = -40^\circ\text{C}$ to 125°C			± 225		
dV_{OS}/dT	Input offset voltage drift OPA207D	$T_A = -40^\circ\text{C}$ to 85°C		± 0.2	± 8	$\mu\text{V}/^\circ\text{C}$
		$T_A = -40^\circ\text{C}$ to 125°C		± 0.2	± 8	
	Input offset voltage drift OPA207DGK and OPA207DBV	$T_A = 0^\circ\text{C}$ to 85°C		± 0.2	± 1.1	
		$T_A = -40^\circ\text{C}$ to 125°C		± 0.2	± 1.1	
PSRR	Input offset voltage versus power supply	$V_S = \pm 2.25\text{ V}$ to $\pm 18\text{ V}$		± 0.5	± 3	$\mu\text{V}/\text{V}$
		$V_S = \pm 2.25\text{ V}$ to $\pm 18\text{ V}$, $T_A = -40^\circ\text{C}$ to 85°C			± 4.2	
		$V_S = \pm 2.25\text{ V}$ to $\pm 18\text{ V}$, $T_A = -40^\circ\text{C}$ to 125°C			± 5	
INPUT BIAS CURRENT						
I_B	Input bias current			± 0.2	± 1.5	nA
		$T_A = -40^\circ\text{C}$ to 85°C			± 2	
		$T_A = -40^\circ\text{C}$ to 125°C			± 7	
I_{OS}	Input offset current			± 0.13	± 1.5	nA
		$T_A = -40^\circ\text{C}$ to 85°C			± 2	
		$T_A = -40^\circ\text{C}$ to 125°C			± 7	
NOISE						
	Input voltage noise	$f = 0.1\text{ Hz}$ to 10 Hz		0.16		μV_{PP}
				0.024		μV_{RMS}
e_N	Input voltage noise density	$f = 1\text{ Hz}$		9.5		$\text{nV}/\sqrt{\text{Hz}}$
		$f = 10\text{ Hz}$		7.5		
		$f = 100\text{ Hz}$		7.5		
		$f = 1\text{ kHz}$		7.5		
i_N	Input current noise	$f = 1\text{ kHz}$		0.18		$\text{pA}/\sqrt{\text{Hz}}$
INPUT VOLTAGE RANGE						
V_{CM}	Common-mode voltage range		$(V-) + 1.25$	$(V+) - 1.25$		V
CMRR	Common-mode rejection ratio	$(V-) + 1.25\text{ V} < V_{CM} < (V+) - 1.25\text{ V}$	120	140		dB
		$(V-) + 1.25\text{ V} < V_{CM} < (V+) - 1.25\text{ V}$, $T_A = -40^\circ\text{C}$ to 125°C	115	140		
INPUT CAPACITANCE						
Z_{ID}	Differential			3 14		$\text{M}\Omega$ pF
Z_{ICM}	Common-mode			1 1		$\text{G}\Omega$ pF
OPEN-LOOP GAIN						
A_{OL}	Open-loop voltage gain	$(V-) + 200\text{ mV} < V_O < (V+) - 200\text{ mV}$, $R_L = 10\text{ k}\Omega$		130	140	dB
			$T_A = -40^\circ\text{C}$ to 125°C	126		
		$(V-) + 200\text{ mV} < V_O < (V+) - 200\text{ mV}$, $R_L = 2\text{ k}\Omega$	OPA207D, OPA207DGK	120	140	
		$(V-) + 300\text{ mV} < V_O < (V+) - 300\text{ mV}$, $R_L = 2\text{ k}\Omega$	OPA207DBV	130	140	
		$(V-) + 200\text{ mV} < V_O < (V+) - 200\text{ mV}$, $R_L = 2\text{ k}\Omega$	$T_A = -40^\circ\text{C}$ to 125°C , OPA207D, OPA207DGK	114		
	$(V-) + 300\text{ mV} < V_O < (V+) - 300\text{ mV}$, $R_L = 2\text{ k}\Omega$	$T_A = -40^\circ\text{C}$ to 125°C , OPA207DBV	120			

Electrical Characteristics (continued)

at $V_S = \pm 15\text{ V}$, $T_A = 25^\circ\text{C}$, $R_L = 2\text{ k}\Omega$ connected to $V_S / 2$, $V_{CM} = V_S / 2$, and $V_{OUT} = V_S/2$ (unless otherwise noted)

PARAMETER		TEST CONDITIONS	MIN	TYP	MAX	UNIT
FREQUENCY RESPONSE						
GBW	Gain-bandwidth product			1.3		MHz
SR	Slew rate	10-V step, $G = 1$		2.7		V/ μs
t_s	Settling time	To 0.1%, 10-V step, $G = 1$		4.8		μs
		To 0.01%, 10-V step, $G = 1$		5.4		
		To 0.001%, 10-V step, $G = 1$		8.1		
	Overload recovery time	$V_{IN} \times \text{gain} > V_S$		1.1		μs
	Total harmonic distortion + noise (THD+N)	$V_O = 3 V_{RMS}$, $G = 1$, $f = 1\text{ kHz}$, $R_L = 10\text{ k}\Omega$		-114		dB
OUTPUT						
	Voltage output swing from rail	$T_A = 25^\circ\text{C}$, no load, OPA207DBV		15	40	mV
		$T_A = 25^\circ\text{C}$, $R_L = 10\text{ k}\Omega$, OPA207DBV		40	60	
		$T_A = 25^\circ\text{C}$, $R_L = 2\text{ k}\Omega$, OPA207DBV		80	140	
		$T_A = 25^\circ\text{C}$, no load, OPA207D, OPA207DGK		15	30	
		$T_A = 25^\circ\text{C}$, $R_L = 10\text{ k}\Omega$, OPA207D, OPA207DGK		40	50	
		$T_A = 25^\circ\text{C}$, $R_L = 2\text{ k}\Omega$, OPA207D, OPA207DGK		80	125	
		$T_A = -40^\circ\text{C}$ to 125°C , $R_L = 10\text{ k}\Omega$		75	200	
I_{SC}	Short-circuit current	Sinking		-40		mA
		Sourcing		40		
C_{LOAD}	Capacitive load drive			200		pf
R_O	Open-loop output impedance	$f = 1\text{ MHz}$		45		Ω
POWER SUPPLY						
I_Q	Quiescent current per amplifier	$I_O = 0\text{ A}$		350	375	μA
		$I_O = 0\text{ A}$, $T_A = -40^\circ\text{C}$ to 125°C			450	
	Turnon time	At $T_A = 25^\circ\text{C}$, $V_S = 36\text{ V}$, V_S ramp rate $> 0.3\text{ V}/\mu\text{s}$		27		μs

6.6 Typical Characteristics

at $T_A = 25^\circ\text{C}$, $V_S = \pm 15\text{ V}$, and $R_L = 2\text{ k}\Omega$ (unless otherwise noted)

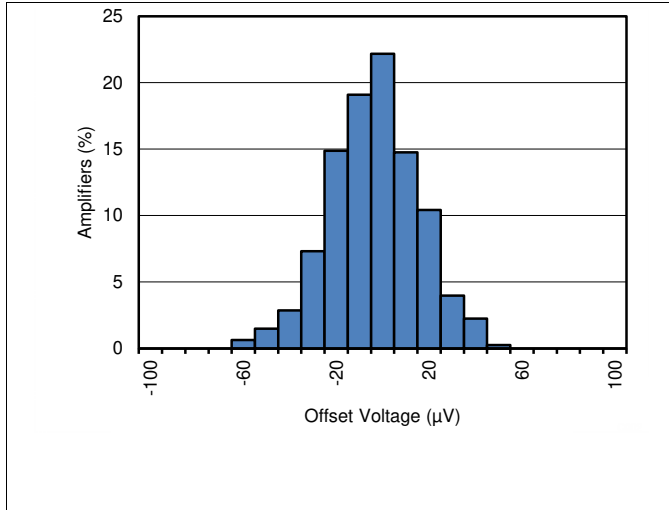

Figure 1. Input Referred Offset Voltage Distribution

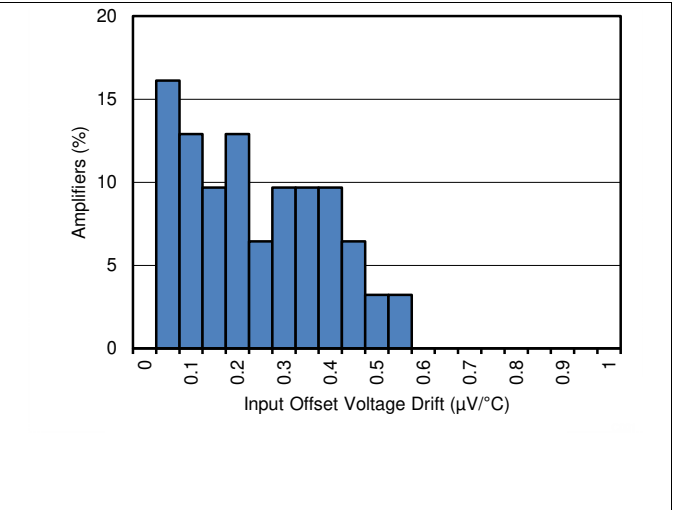

Figure 2. Input Referred Offset Voltage Drift Distribution

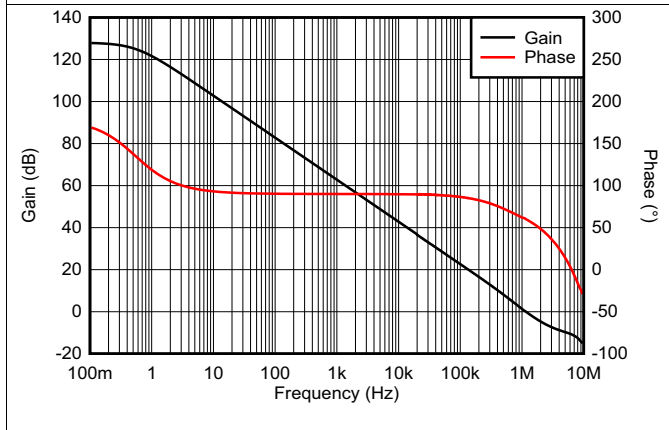

Figure 3. Open-Loop Gain and Phase vs Frequency

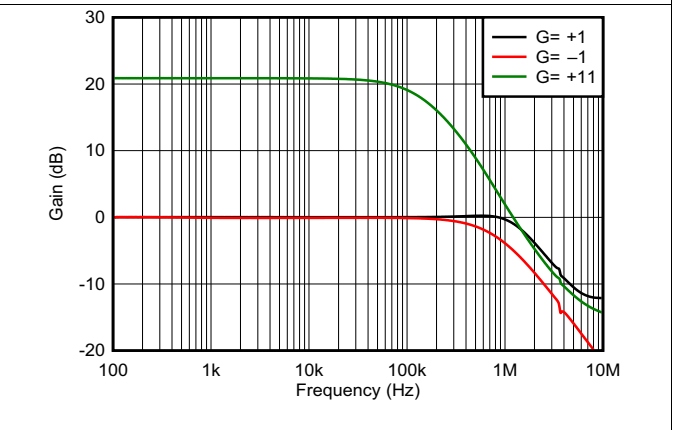

Figure 4. Closed Loop Gain vs Frequency

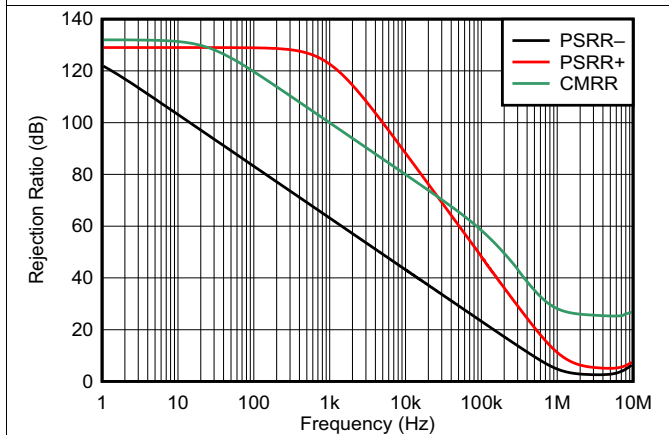

Figure 5. Power Supply Rejection Ratio and Common-Mode Rejection Ratio vs Frequency

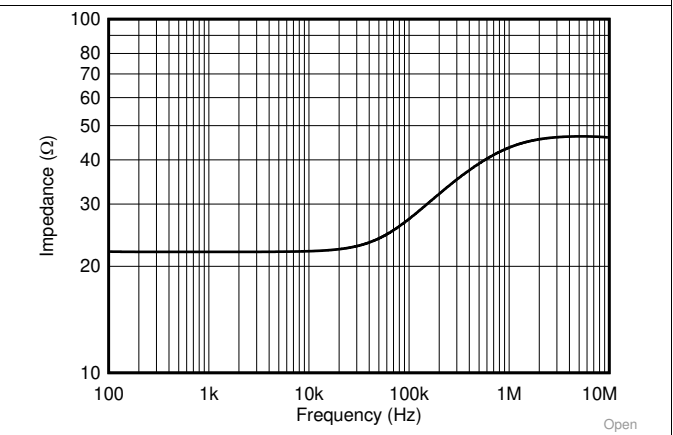

Figure 6. Open-Loop Output Impedance vs Frequency

Typical Characteristics (continued)

at $T_A = 25^\circ\text{C}$, $V_S = \pm 15\text{ V}$, and $R_L = 2\text{ k}\Omega$ (unless otherwise noted)

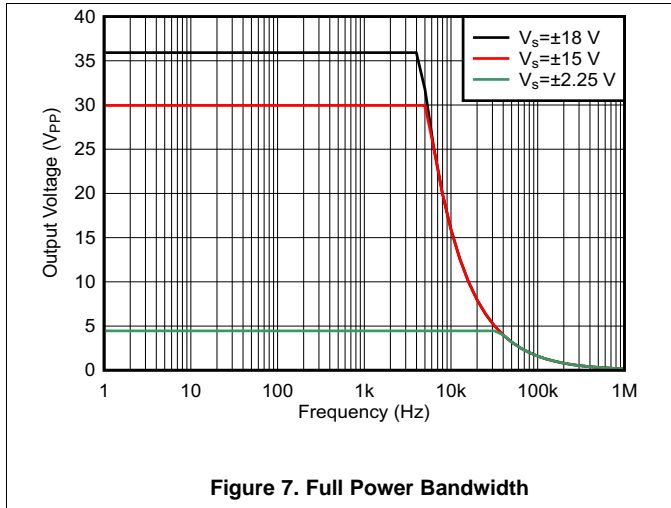

Figure 7. Full Power Bandwidth

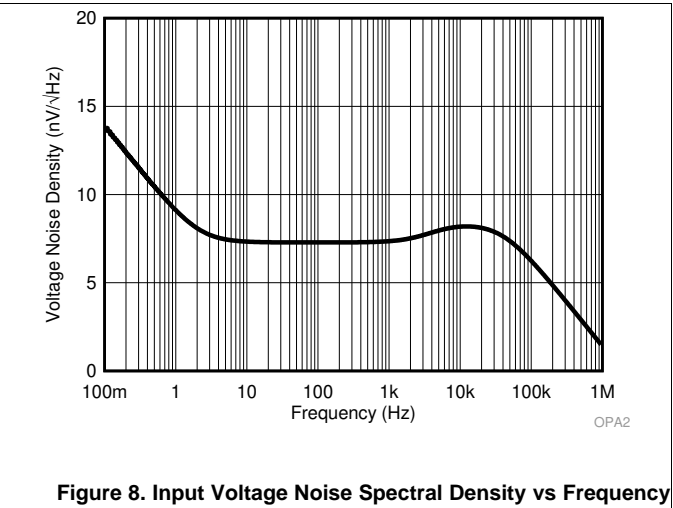

Figure 8. Input Voltage Noise Spectral Density vs Frequency

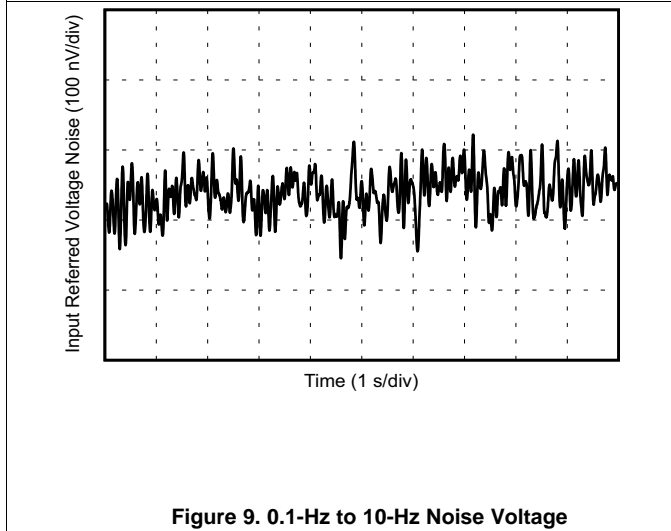

Figure 9. 0.1-Hz to 10-Hz Noise Voltage

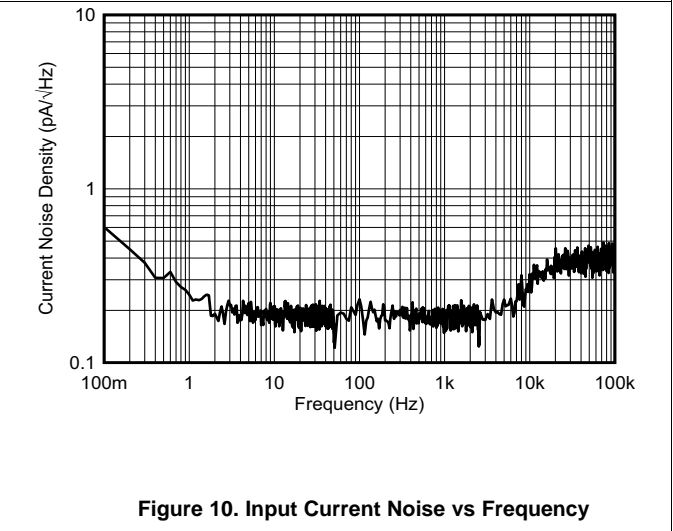

Figure 10. Input Current Noise vs Frequency

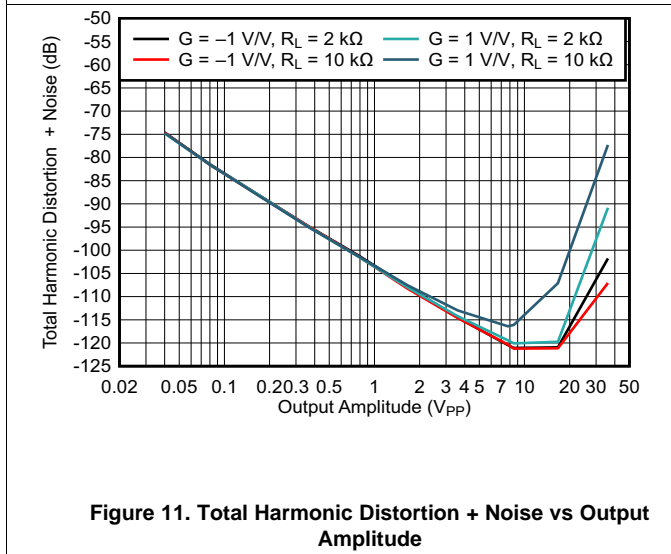

Figure 11. Total Harmonic Distortion + Noise vs Output Amplitude

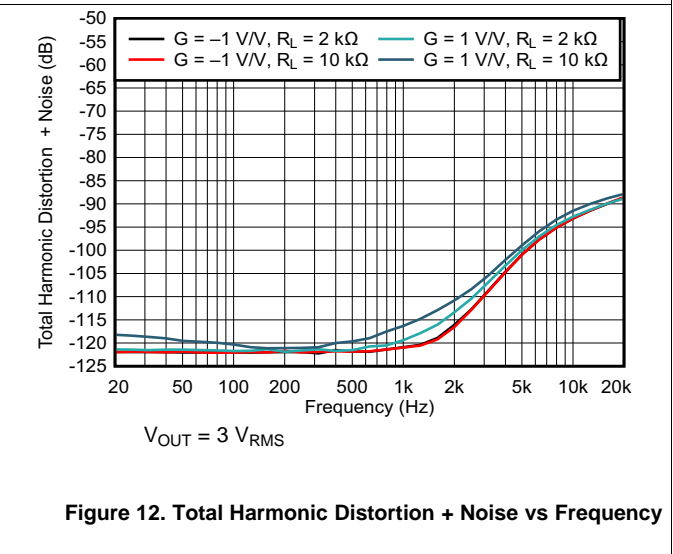

Figure 12. Total Harmonic Distortion + Noise vs Frequency

Typical Characteristics (continued)

at $T_A = 25^\circ\text{C}$, $V_S = \pm 15\text{ V}$, and $R_L = 2\text{ k}\Omega$ (unless otherwise noted)

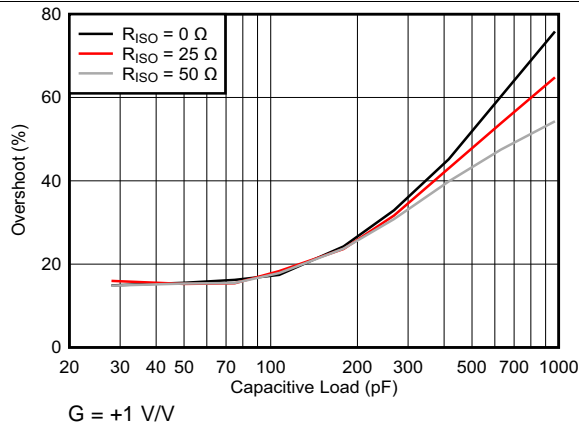

Figure 13. Overshoot vs Capacitive Load

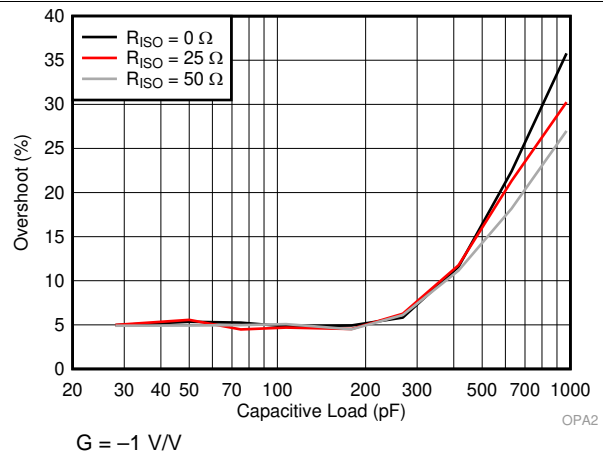

Figure 14. Overshoot vs Capacitive Load

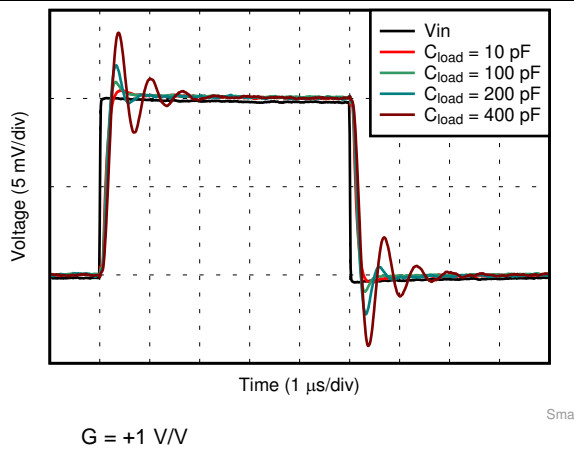

Figure 15. Small-Signal Step Response

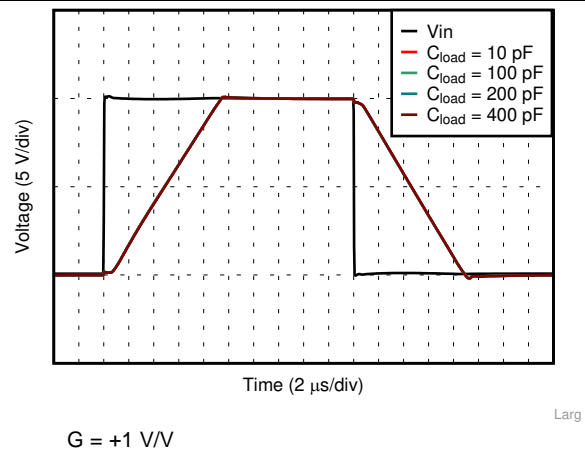

Figure 16. Large-Signal Step Response

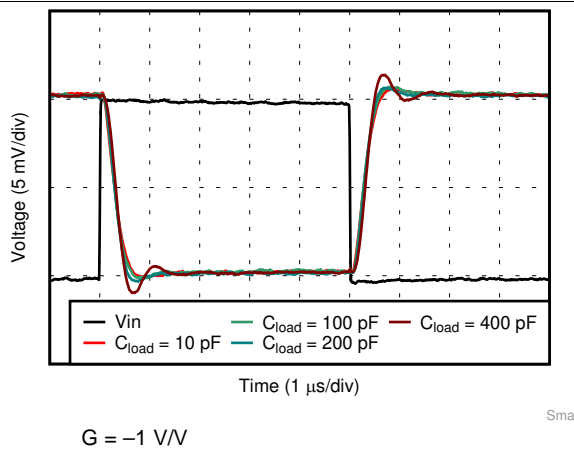

Figure 17. Small-Signal Step Response

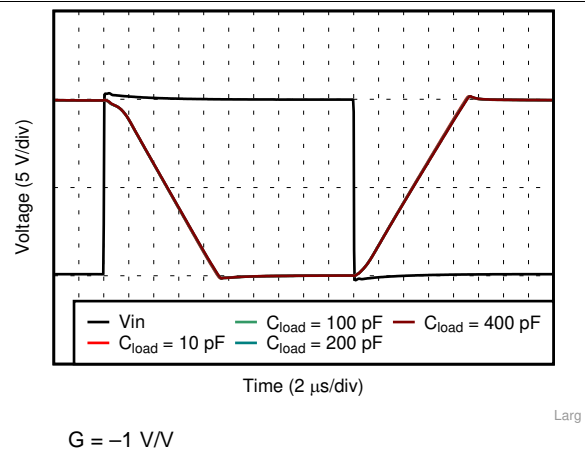
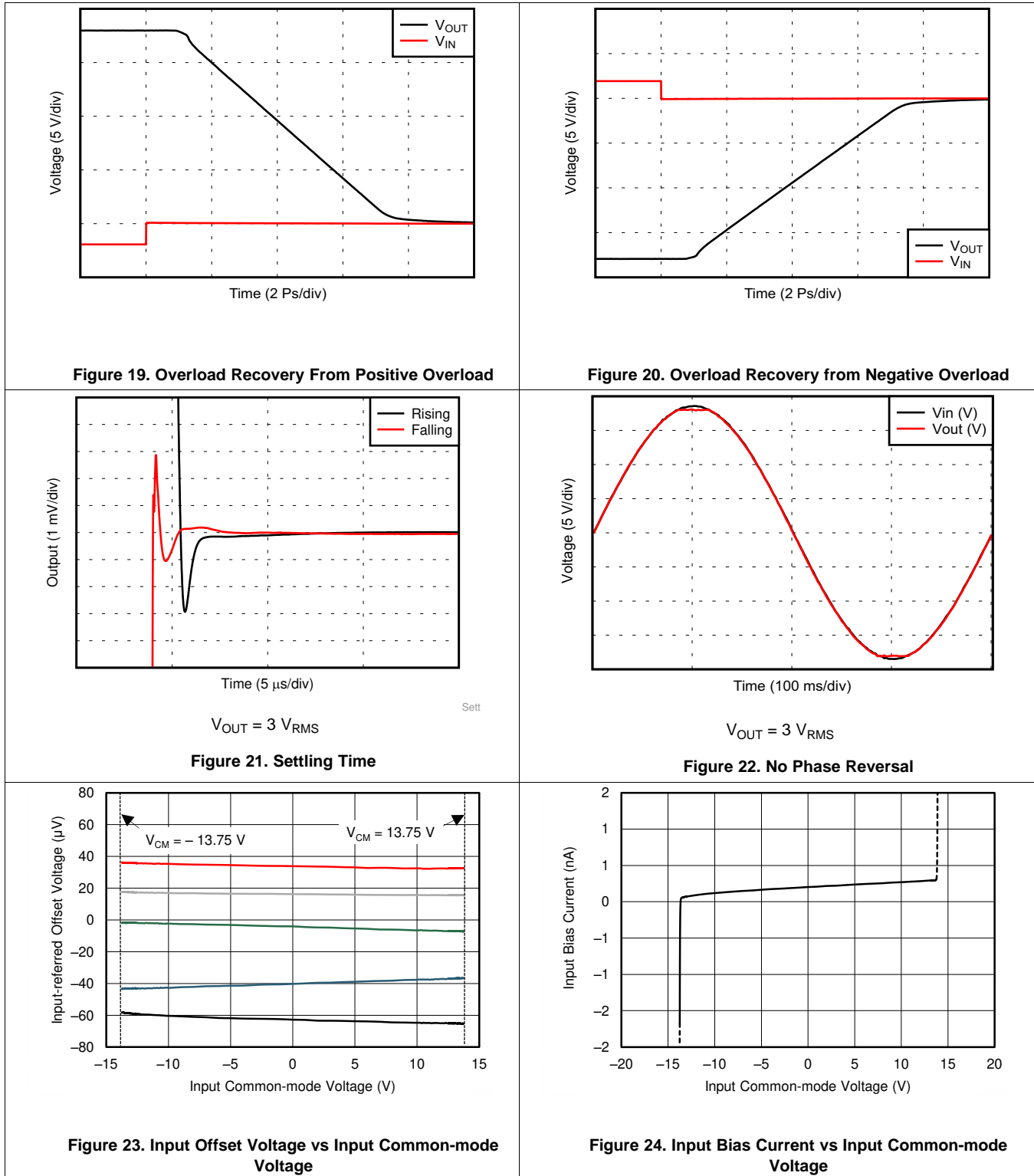

Figure 18. Large-Signal Step Response

Typical Characteristics (continued)

at $T_A = 25^\circ\text{C}$, $V_S = \pm 15\text{ V}$, and $R_L = 2\text{ k}\Omega$ (unless otherwise noted)



Typical Characteristics (continued)

at $T_A = 25^\circ\text{C}$, $V_S = \pm 15\text{ V}$, and $R_L = 2\text{ k}\Omega$ (unless otherwise noted)

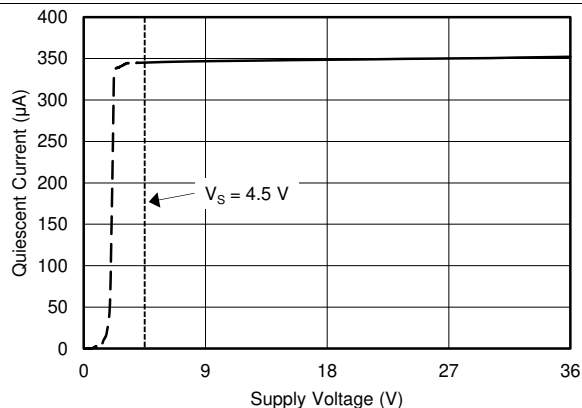

Figure 25. Quiescent Current vs Power Supply Voltage

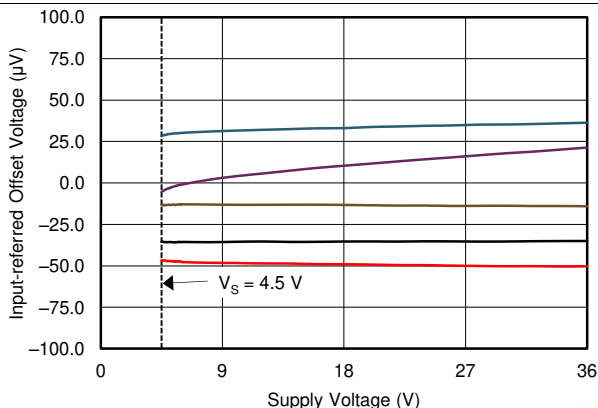

Figure 26. Input Offset Voltage vs Power Supply Voltage

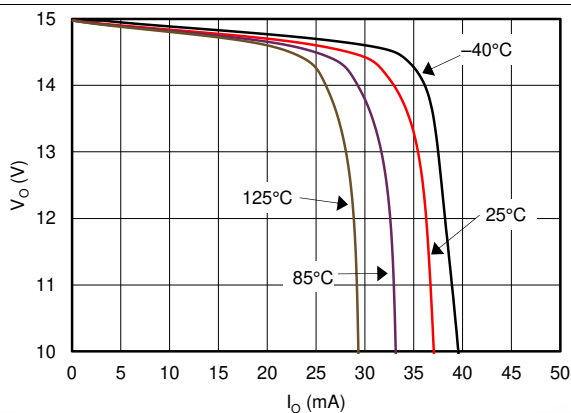

Figure 27. Output Voltage vs Output Current (Sourcing)

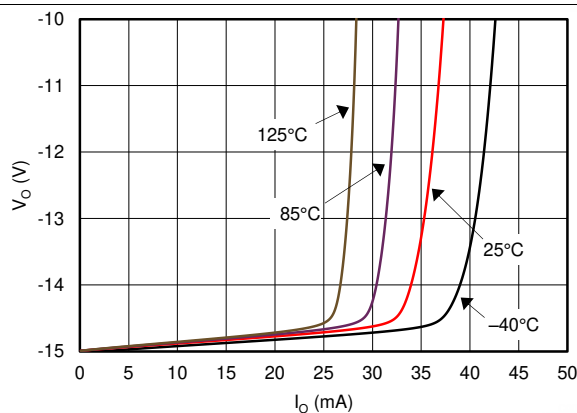

Figure 28. Output Voltage vs Output Current (Sinking)

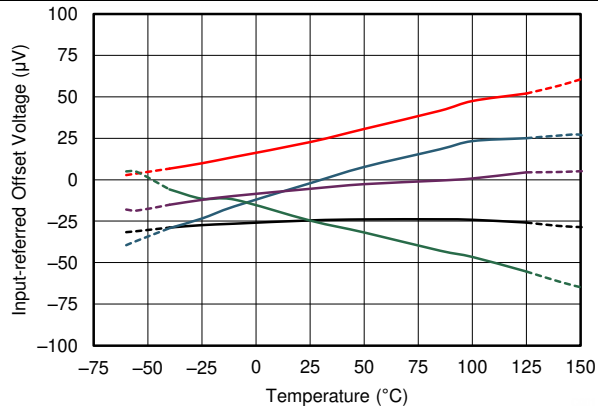

Figure 29. Input Offset Voltage vs Temperature

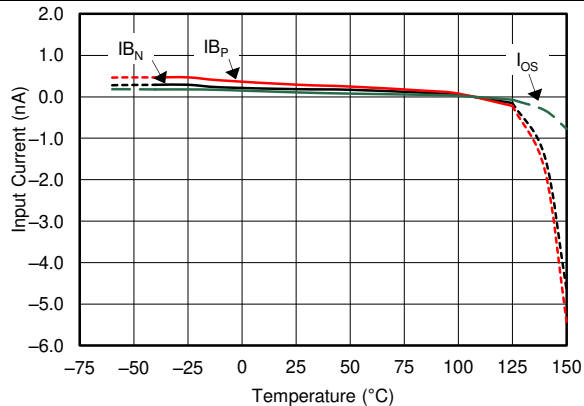

Figure 30. Input Bias Current vs Temperature

Typical Characteristics (continued)

at $T_A = 25^\circ\text{C}$, $V_S = \pm 15\text{ V}$, and $R_L = 2\text{ k}\Omega$ (unless otherwise noted)

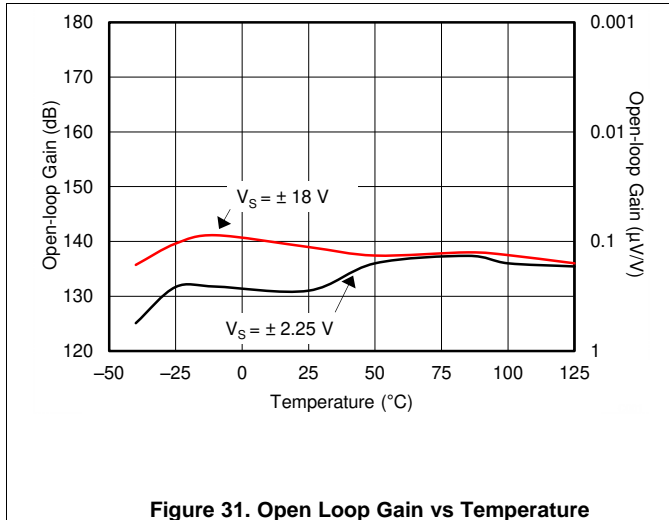

Figure 31. Open Loop Gain vs Temperature

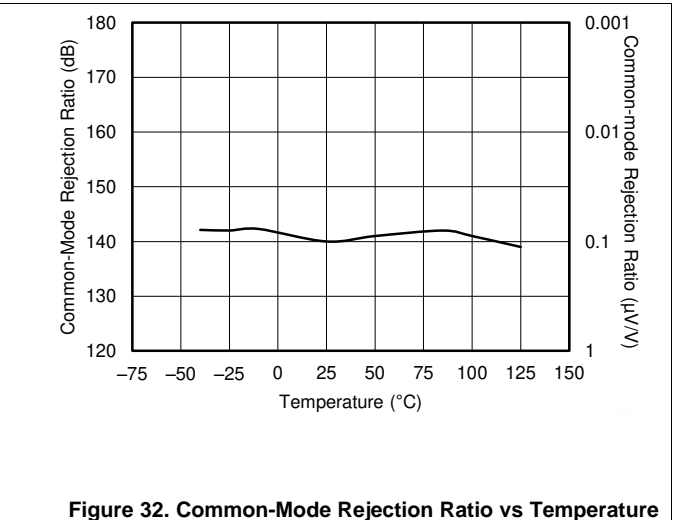

Figure 32. Common-Mode Rejection Ratio vs Temperature

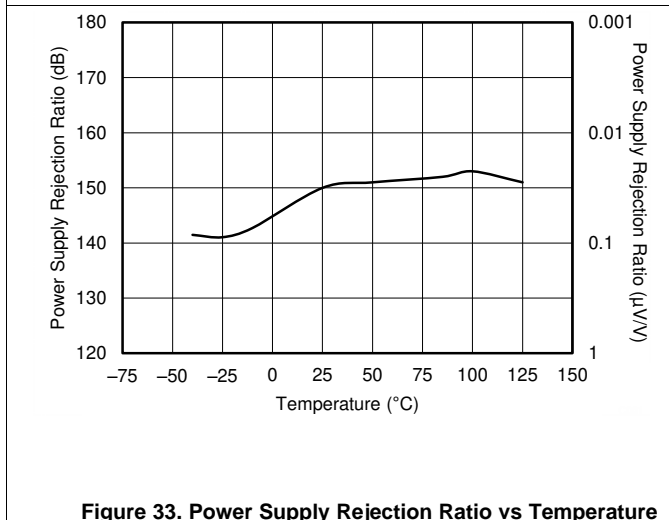

Figure 33. Power Supply Rejection Ratio vs Temperature

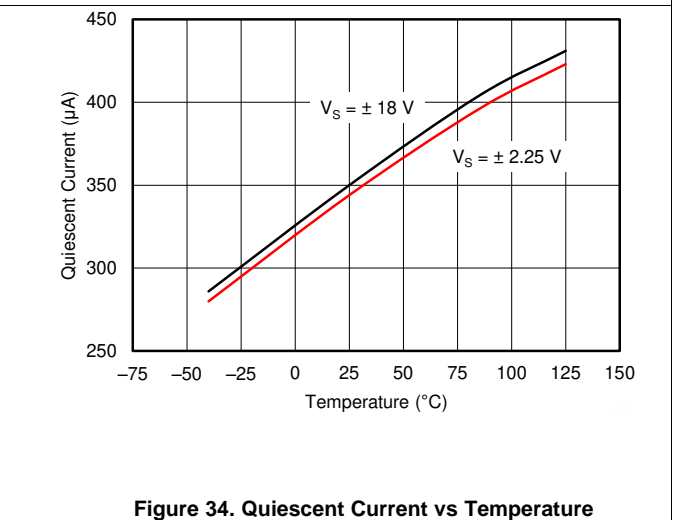

Figure 34. Quiescent Current vs Temperature

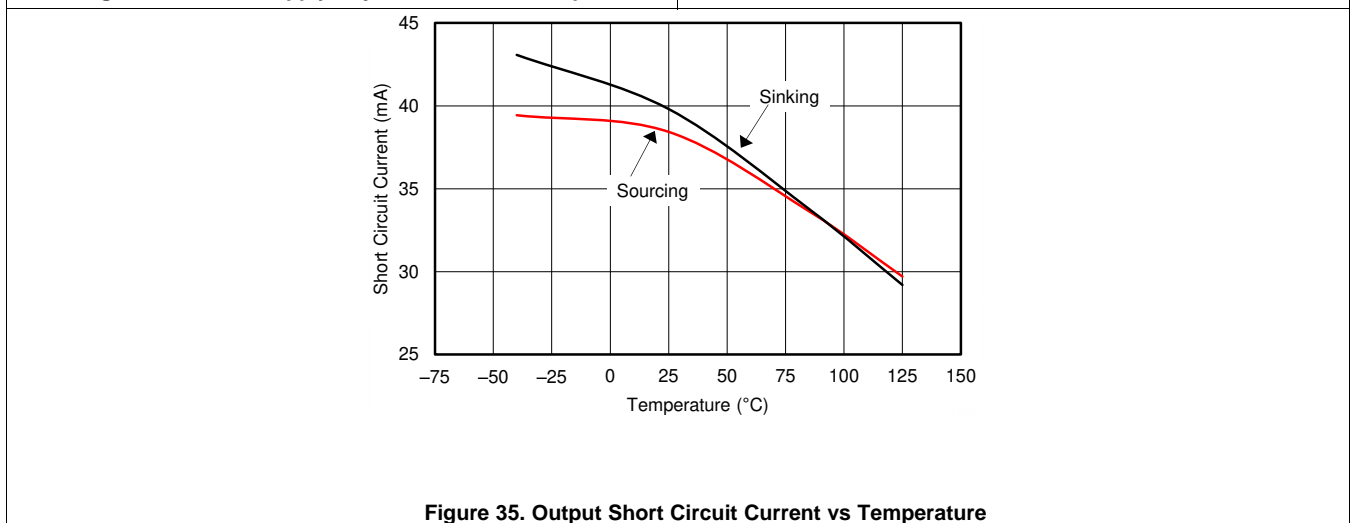

Figure 35. Output Short Circuit Current vs Temperature

7 Detailed Description

7.1 Overview

The OPA207 precision operational amplifier replaces the industry standard OP-177. The OPA207 offers improved noise, wider output voltage swing, has twice the bandwidth, ten times the slew rate and consumes only half the quiescent current as the OP-177. Additional features include ultralow offset voltage and drift, low bias current, high common-mode rejection, and high power supply rejection.

7.2 Functional Block Diagram

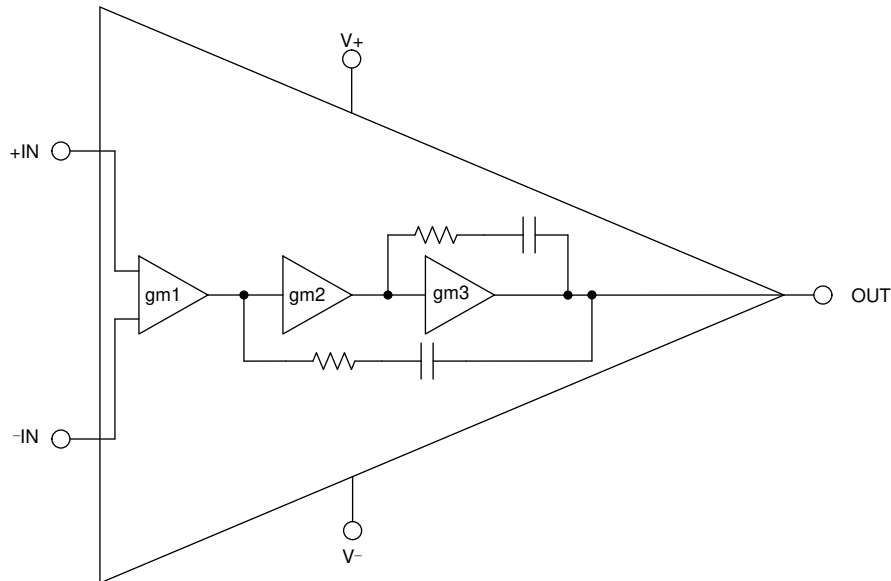

Copyright © 2017, Texas Instruments Incorporated

7.3 Feature Description

The OPA207 is unity-gain stable and free from unexpected output phase reversal, making it easy to use in a wide range of applications. Applications with noisy or high-impedance power supplies may require decoupling capacitors close to the device pins. In most cases 0.1- μ F capacitors are adequate.

7.3.1 Operating Voltage

The OPA207 operates from ± 2.25 V to ± 18 V supplies with excellent performance. Key parameters are assured over the specified temperature range, -40°C to 125°C . Most behavior remains unchanged through the full operating voltage range (± 2.25 V to ± 18 V). Parameters which vary significantly with operating voltage or temperature are shown in [Typical Characteristics](#).

Feature Description (continued)

7.3.2 Input Protection

The input stage of the OPA207 is internally protected with resistors in series with diode clamps as shown in Figure 36. The inputs can withstand ± 10 V differential inputs without damage and the maximum input current should be limited to 10 mA or less. The protection diodes conduct current when the inputs are over-driven such as when the opamp output is slewing. This may disturb the slewing behavior of unity-gain follower applications, but will not damage the operational amplifier.

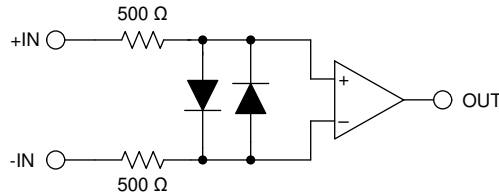

Copyright © 2017, Texas Instruments Incorporated

Figure 36. Simplified OPA207 Input Protection Circuit

7.3.3 ESD Protection

The OPA207 is internally protected against ESD events that can occur during manufacturing, handling, or printed-circuit-board assembly. The internal ESD protection diodes are not intended to protect the OPA207 during normal operation when the device is operating under power. In cases where the inputs or output can be driven above the positive power supply or below the negative power supply care must be taken to limit the current through the internal diodes to 10 mA or less. In harsh electrical environments external protection circuitry may be required and is dependant upon the application requirements and environmental conditions.

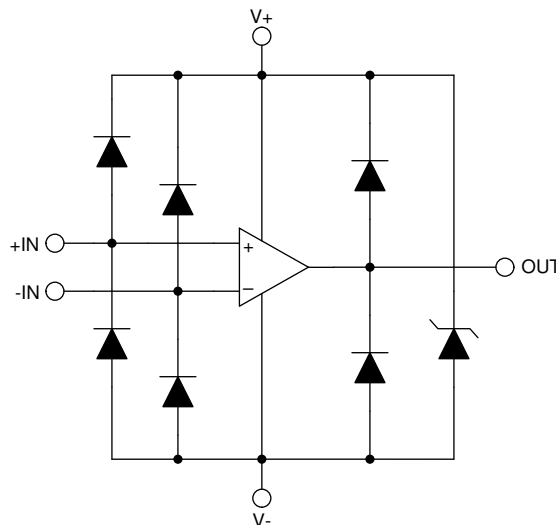

Copyright © 2017, Texas Instruments Incorporated

Figure 37. Simplified OPA207 ESD Protection Circuit

Feature Description (continued)

7.3.4 Input Stage Linearization

The OPA207 uses linearization techniques to reduce the total harmonic distortion. Figure 38 illustrates the linearization concept, and Figure 38 illustrates the total harmonic distortion performance of the OPA207.

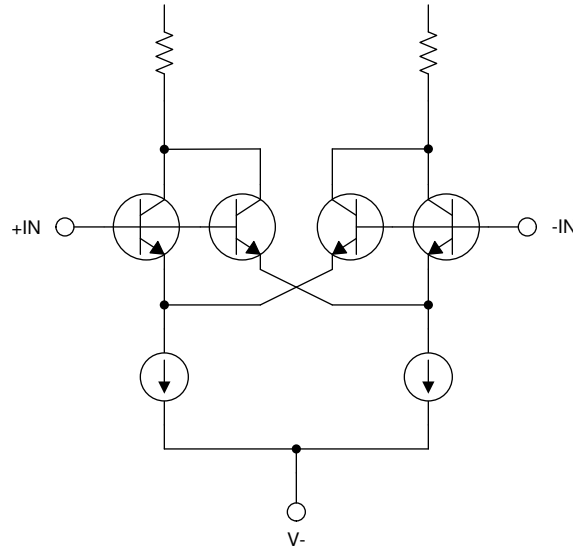

Copyright © 2017, Texas Instruments Incorporated

Figure 38. Simplified Input Stage Linearization Circuit

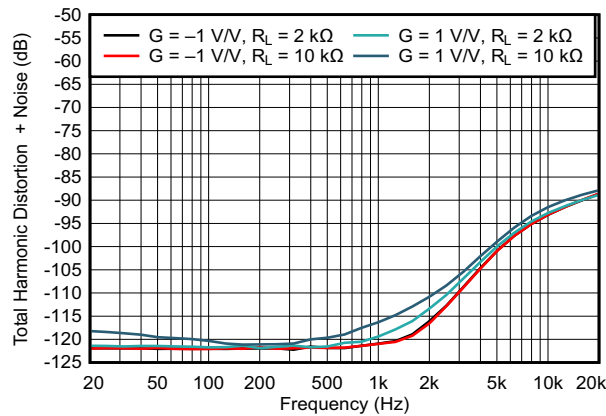
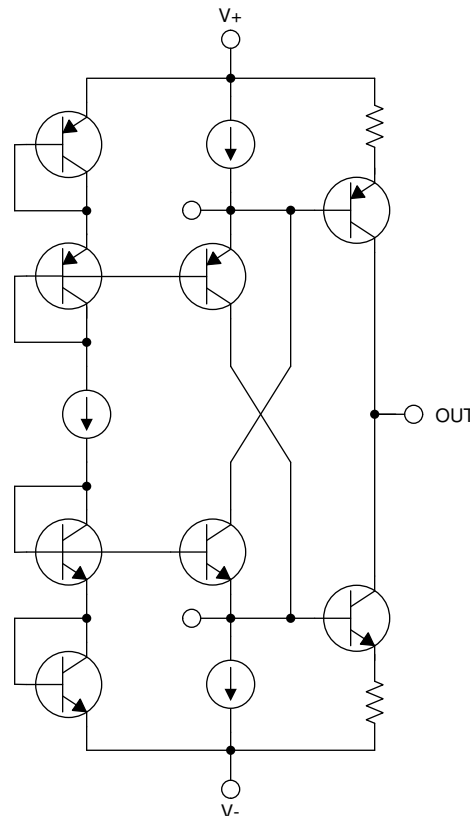

Figure 39. Total Harmonic Distortion

Feature Description (continued)

7.3.5 Rail-to-Rail Output

The OPA207 uses a rail-to-rail output stage capable of swinging within a few millivolts from either power supply rail while maintaining high open-loop gain. [Figure 40](#) shows a simplified drawing of the output stage circuit. Resistors connected in series with each output transistor ensure a consistent output current limit. Limiting the output current in this way ensures reliable operation of the OPA207 under short circuited conditions and protects sensitive loads from being damaged by excessive current. [Figure 41](#) and [Figure 42](#) illustrate the maximum output current available from the OPA207 at various temperatures.



Copyright © 2017, Texas Instruments Incorporated

Figure 40. Simplified Rail-to-Rail Output Stage Circuit

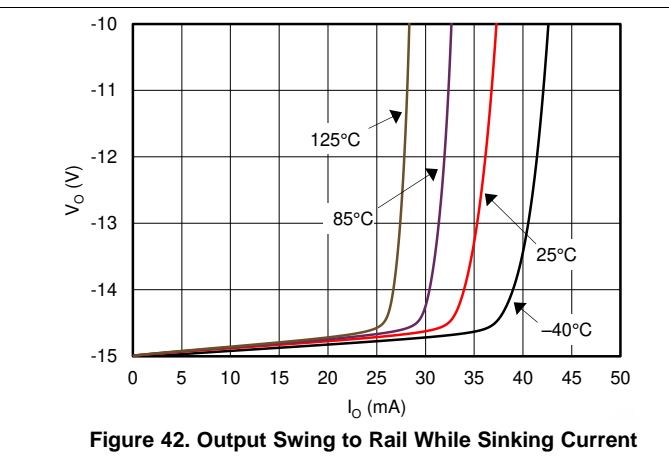
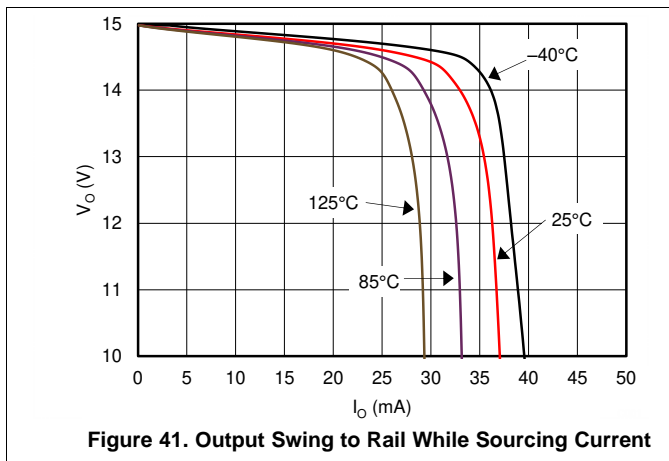

Feature Description (continued)

7.3.6 Low Input Bias Current

The OPA207 uses super-beta bipolar transistors and employs an input bias current cancellation technique. This combination results in very low input bias currents that remain low over the full specified temperature range from -40°C to $+125^{\circ}\text{C}$ unlike CMOS or JFET amplifiers whose input bias currents typically double every 10°C and can be extremely high at 125°C . Figure 43 illustrates the comparison between the OPA207 and typical CMOS or JFET amplifiers.

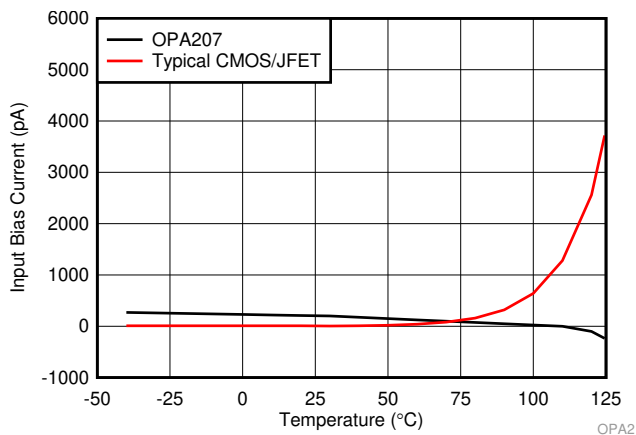
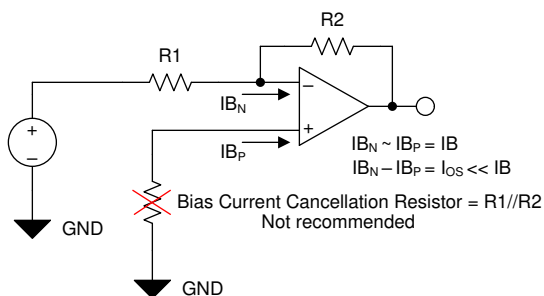

Figure 43. Input Bias Current vs Temperature

It is common practice to place a bias current cancellation resistor as illustrated in Figure 42. This approach works well with amplifiers that do not employ an internal input bias current cancellation technique. Because the OPA207 uses an internal bias current cancellation technique, TI does not recommend the bias cancellation resistor.



Copyright © 2017, Texas Instruments Incorporated

Figure 44. Bias Current Cancellation Resistor — Not Recommended

Feature Description (continued)

7.3.7 Slew Boost

The OPA207 uses a novel internal slew-boost technique. This method allows the OPA207 to consume very low power yet still achieve a high slew rate of 3.6 V/μs. This makes the OPA207 ideal for applications that require low noise and high out voltage swings where the high slew rate is necessary to achieve fast settling times.

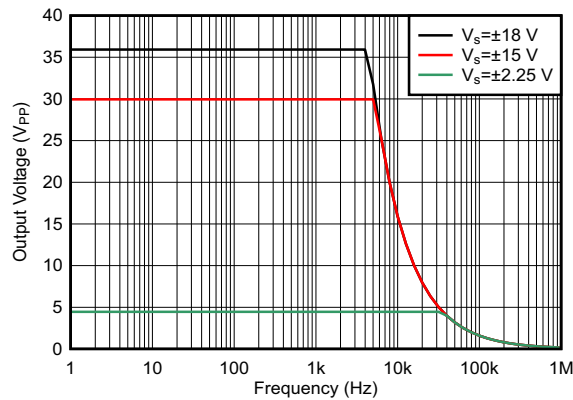

Figure 45. Full Power Bandwidth

7.3.8 EMI Rejection Ratio (EMIRR)

The electromagnetic interference (EMI) rejection ratio, or EMIRR, describes the EMI immunity of operational amplifiers. An adverse effect that is common to many operational amplifiers is a change in the offset voltage as a result of RF signal rectification. An operational amplifier that is more efficient at rejecting this change in offset as a result of EMI has a higher EMIRR and is quantified by a decibel value. Measuring EMIRR can be performed in many ways, but this report provides the EMIRR IN+, which specifically describes the EMIRR performance when the RF signal is applied to the noninverting input pin of the operational amplifier. In general, only the noninverting input is tested for EMIRR for the following three reasons:

1. Operational amplifier input pins are known to be the most sensitive to EMI, and typically rectify RF signals better than the supply or output pins.
2. The noninverting and inverting operational amplifier inputs have symmetrical physical layouts and exhibit nearly matching EMIRR performance.
3. EMIRR is easier to measure on noninverting pins than on other pins because the noninverting input terminal can be isolated on a printed circuit board (PCB). This isolation allows the RF signal to be applied directly to the noninverting input terminal with no complex interactions from other components or connecting PCB traces.

A more formal discussion of the EMIRR IN+ definition and test method is provided in TI Application Report [EMI Rejection Ratio of Operational Amplifiers](#), available for download at www.ti.com. The EMIRR IN+ of the OPA207 is plotted versus frequency as shown in Figure 46.

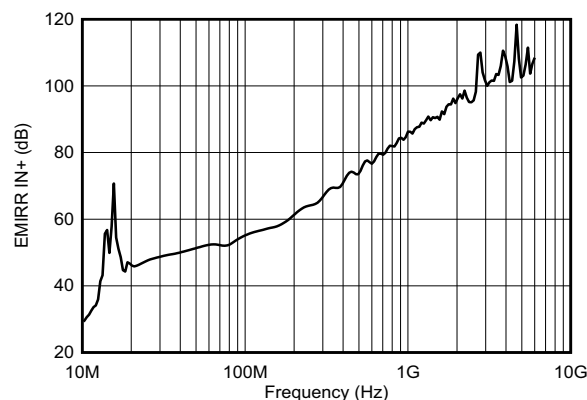

Figure 46. OPA207 EMIRR IN+ vs Frequency

Feature Description (continued)

If available, any dual and quad operational amplifier device versions have nearly similar EMIRR IN+ performance. The OPA207 unity-gain bandwidth is 1 MHz. EMIRR performance below this frequency denotes interfering signals that fall within the operational amplifier bandwidth.

Table 1 shows the EMIRR IN+ values for the OPA207 at particular frequencies commonly encountered in real-world applications. Applications listed in Table 1 may be centered on or operated near the particular frequency shown. This information may be of special interest to designers working with these types of applications, or working in other fields likely to encounter RF interference from broad sources, such as the industrial, scientific, and medical (ISM) radio band.

Table 1. OPA207 EMIRR IN+ for Frequencies of Interest

FREQUENCY	APPLICATION/ALLOCATION	EMIRR IN+
400 MHz	Mobile radio, mobile satellite/space operation, weather, radar, UHF	72 dB
900 MHz	GSM, radio com./nav./GPS (to 1.6 GHz), ISM, aeronautical mobile, UHF	83 dB
1.8 GHz	GSM, mobile personal comm. broadband, satellite, L-band	95 dB
2.4 GHz	802.11b/g/n, Bluetooth [®] , mobile personal comm., ISM, amateur radio/satellite, S-band	94 dB
3.6 GHz	Radiolocation, aero comm./nav., satellite, mobile, S-band	103 dB
5 GHz	802.11a/n, aero comm./nav., mobile comm., space/satellite operation, C-band	102 dB

7.4 Device Functional Modes

The OPA207 has a single functional mode and is operational when the power-supply voltage is greater than 4.5 V (± 2.25 V). The maximum power supply voltage for the OPA207 is 36 V (± 18 V).

8 Application and Implementation

NOTE

Information in the following applications sections is not part of the TI component specification, and TI does not warrant its accuracy or completeness. TI's customers are responsible for determining suitability of components for their purposes. Customers should validate and test their design implementation to confirm system functionality.

8.1 Application Information

Low-pass filters are commonly employed in signal processing applications to reduce noise and prevent aliasing. The OPA207 is designed to construct high-precision active filters. Figure 47 shows a second-order, low-pass filter commonly encountered in signal processing applications.

8.2 Typical Applications

8.2.1 Typical OPA207 Application

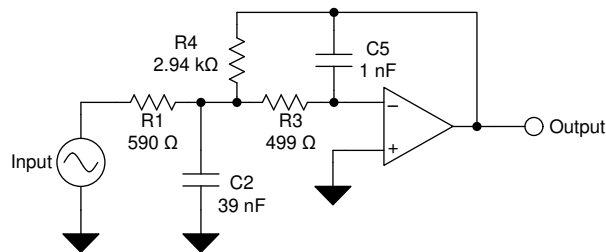

Copyright © 2016, Texas Instruments Incorporated

Figure 47. Typical OPA207 Application Schematic

8.2.1.1 Design Requirements

Use the following parameters for this design example:

- Gain = 5 V/V (inverting gain)
- Low-pass cutoff frequency = 25 kHz
- Second-order Chebyshev filter response with 3-dB gain peaking in the passband

8.2.1.2 Detailed Design Procedure

The infinite-gain multiple-feedback circuit for a low-pass network function is shown in Figure 47. Use Equation 1 to calculate the voltage transfer function.

$$\frac{\text{Output}}{\text{Input}}(s) = \frac{-1/R_1 R_3 C_2 C_5}{s^2 + (s/C_2)(1/R_1 + 1/R_3 + 1/R_4) + 1/R_3 R_4 C_2 C_5} \quad (1)$$

This circuit produces a signal inversion. For this circuit, the gain at dc and the low-pass cutoff frequency are calculated by Equation 2:

$$\text{Gain} = \frac{R_4}{R_1}$$

$$f_c = \frac{1}{2\pi} \sqrt{(1/R_3 R_4 C_2 C_5)} \quad (2)$$

Software tools are readily available to simplify filter design. WEBENCH® Filter Designer is a simple, powerful, and easy-to-use active filter design program. The WEBENCH Filter Designer lets designers create optimized filter designs using a selection of TI operational amplifiers and passive components from TI's vendor partners.

Available as a web-based tool from the WEBENCH® Design Center, WEBENCH® Filter Designer allows to design, optimize, and simulate complete multi-stage active filter solutions within minutes.

Typical Applications (continued)

8.2.1.3 Application Curve

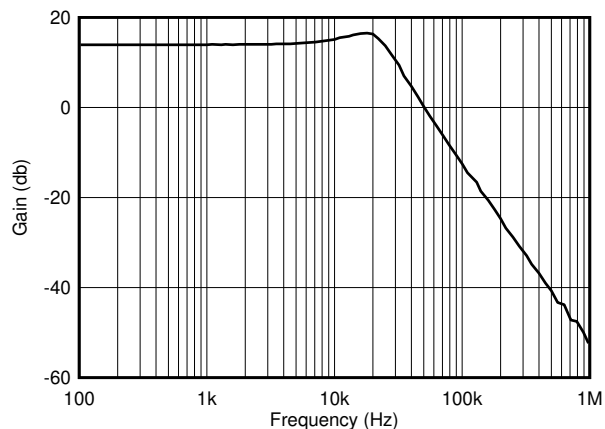
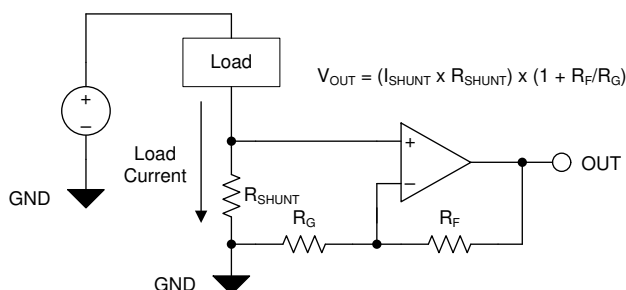

Figure 48. Low-Pass Filter Transfer Function

8.2.2 Precision Low-Side Current Sensing

With low offset voltage and low offset voltage drift over time and temperature the OPA207 works well for precision low-side current sensing applications as shown in [Figure 49](#)



Copyright © 2017, Texas Instruments Incorporated

Figure 49. Precision Low-Side Current Sensing

Typical Applications (continued)

8.2.3 Precision Buffer With Increased Output Current

The OPA207 can be configured as illustrated in [Figure 50](#) to drive low impedance loads. In [Figure 50](#), the OPA207 is configured in a gain of +10 V/V, and the output current is boosted by the NPN (2N2904) and PNP (2N2906) bipolar transistors. For low output voltages the OPA207 supplies the load current directly through the 100-Ω resistor. The bipolar transistors begin to supply current when the voltage drop across the 100-Ω resistor exceeds approximately 500 mV. [Figure 50](#) illustrates the results for a 50-Ω load resistor driven with a 10-V step at the output. This results in a 200-mA current supplied by the circuit.

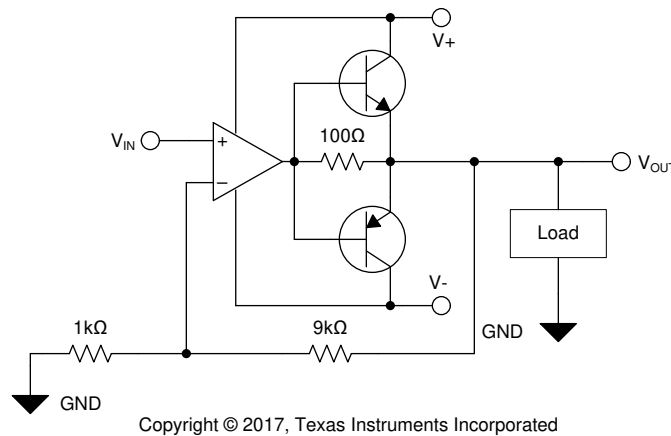

Figure 50. Precision Buffer (G = 10 V/V) With High Output Drive Capability

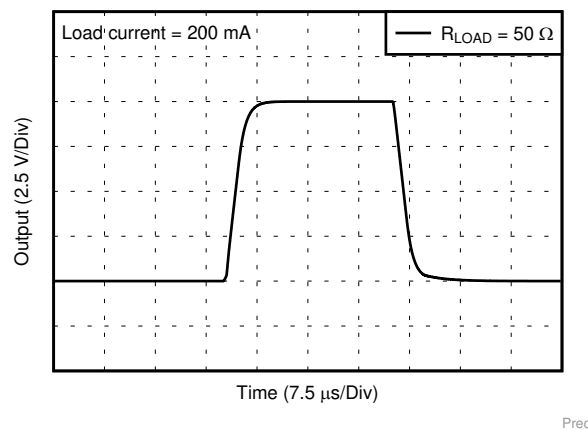

Figure 51. 50-Ω Load Driven With a 10-V Step

9 Power Supply Recommendations

The OPA207 is specified for operation from 4.5 V to 36 V (± 2.25 V to ± 18 V); many specifications apply from -40°C to $+125^{\circ}\text{C}$. Parameters that can exhibit significant variance with regard to operating voltage or temperature are presented in the [Typical Characteristics](#).

CAUTION

Supply voltages larger than 36 V can permanently damage the device; see the [Absolute Maximum Ratings](#).

Place 0.1- μF bypass capacitors close to the power-supply pins to reduce errors coupling in from noisy or high-impedance power supplies. For more detailed information on bypass capacitor placement, refer to the [Layout Guidelines](#).

10 Layout

10.1 Layout Guidelines

The OPA207 series has low offset voltage and drift. To achieve highest performance, optimize the circuit layout and mechanical conditions. Offset voltage and drift can be degraded by small thermoelectric potentials at the op amp inputs. Connections of dissimilar metals generate thermal potential, which can degrade the ultimate performance of the OPA207. These thermal potentials can be made to cancel by assuring that they are equal in both input terminals.

- Keep the thermal mass of the connections to the two input terminals similar.
- Locate heat sources as far as possible from the critical input circuitry.
- Shield operational amplifier and input circuitry from air currents, such as cooling fans.

For best operational performance of the device, use good PCB layout practices, including:

- Noise can propagate into analog circuitry through the power pins of the circuit as a whole and op amp itself. Bypass capacitors are used to reduce the coupled noise by providing low-impedance power sources local to the analog circuitry.
 - Connect low-ESR, 0.1- μF ceramic bypass capacitors between each supply pin and ground, placed as close as possible to the device. A single bypass capacitor from $V+$ to ground is applicable for single-supply applications.
- Separate grounding for analog and digital portions of circuitry is one of the simplest and most-effective methods of noise suppression. One or more layers on multilayer PCBs are usually devoted to ground planes. A ground plane helps distribute heat and reduces EMI noise pickup. Make sure to physically separate digital and analog grounds paying attention to the flow of the ground current.
- In order to reduce parasitic coupling, run the input traces as far away from the supply or output traces as possible. If these traces cannot be kept separate, crossing the sensitive trace perpendicular is much better as opposed to in parallel with the noisy trace.
- Place the external components as close as possible to the device. As shown in [Layout Example](#), keeping RF and RG close to the inverting input minimizes parasitic capacitance.
- Keep the length of input traces as short as possible. Always remember that the input traces are the most sensitive part of the circuit.
- Consider a driven, low-impedance guard ring around the critical traces. A guard ring can significantly reduce leakage currents from nearby traces that are at different potentials.
- For best performance, TI recommends cleaning the PCB following board assembly.
- Any precision integrated circuit may experience performance shifts due to moisture ingress into the plastic package. Following any aqueous PCB cleaning process, TI recommends baking the PCB assembly to remove moisture introduced into the device packaging during the cleaning process. A low temperature, post-cleaning bake at 85°C for 30 minutes is sufficient for most circumstances.

10.2 Layout Example

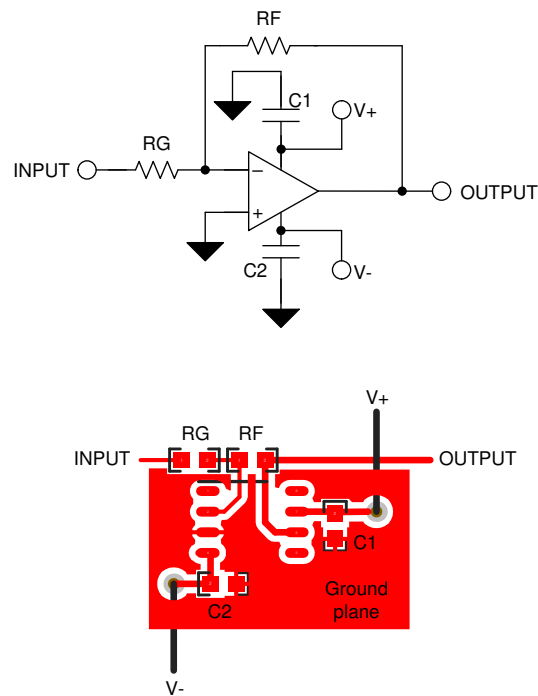

Copyright © 2017, Texas Instruments Incorporated

Figure 52. OPA207 Layout Example for the Inverting Configuration

11 Device and Documentation Support

11.1 Device Support

11.1.1 Development Support

11.1.1.1 *Webench Filter Designer Tool*

WEBENCH® Filter Designer is a simple, powerful, and easy-to-use active filter design program. The WEBENCH Filter Designer lets you create optimized filter designs using a selection of TI operational amplifiers and passive components from TI's vendor partners.

11.1.1.2 *TINA-TI™ (Free Software Download)*

TINA™ is a simple, powerful, and easy-to-use circuit simulation program based on a SPICE engine. TINA-TI is a free, fully-functional version of the TINA software, preloaded with a library of macro models in addition to a range of both passive and active models. TINA-TI provides all the conventional dc, transient, and frequency domain analysis of SPICE, as well as additional design capabilities.

Available as a [free download](#) from the Analog eLab Design Center, TINA-TI offers extensive post-processing capability that allows users to format results in a variety of ways. Virtual instruments offer the ability to select input waveforms and probe circuit nodes, voltages, and waveforms, creating a dynamic quick-start tool.

NOTE

These files require that either the TINA software (from DesignSoft™) or TINA-TI software be installed. Download the free TINA-TI software from the [TINA-TI folder](#).

11.1.1.3 *TI Precision Designs*

The OPA207 is featured in several TI Precision Designs, available online at <http://www.ti.com/ww/en/analog/precision-designs/>. TI Precision Designs are analog solutions created by TI's precision analog applications experts and offer the theory of operation, component selection, simulation, complete PCB schematic and layout, bill of materials, and measured performance of many useful circuits.

11.2 Documentation Support

11.2.1 Related Documentation

For related documentation, see the following:

- Texas Instruments, [EMI Rejection Ratio of Operational Amplifiers](#)
- Texas Instruments, [Circuit Board Layout Techniques](#)

11.3 Receiving Notification of Documentation Updates

To receive notification of documentation updates, navigate to the device product folder on ti.com. In the upper right corner, click on *Alert me* to register and receive a weekly digest of any product information that has changed. For change details, review the revision history included in any revised document.

11.4 Support Resources

TI E2E™ support forums are an engineer's go-to source for fast, verified answers and design help — straight from the experts. Search existing answers or ask your own question to get the quick design help you need.

Linked content is provided "AS IS" by the respective contributors. They do not constitute TI specifications and do not necessarily reflect TI's views; see TI's [Terms of Use](#).

11.5 Trademarks

TINA-TI, E2E are trademarks of Texas Instruments.
Bluetooth is a registered trademark of Bluetooth SIG, Inc..
TINA, DesignSoft are trademarks of DesignSoft, Inc.
All other trademarks are the property of their respective owners.

11.6 Electrostatic Discharge Caution



These devices have limited built-in ESD protection. The leads should be shorted together or the device placed in conductive foam during storage or handling to prevent electrostatic damage to the MOS gates.

12 Mechanical, Packaging, and Orderable Information

The following pages include mechanical, packaging, and orderable information. This information is the most current data available for the designated devices. This data is subject to change without notice and revision of this document. For browser-based versions of this data sheet, refer to the left-hand navigation.

PACKAGING INFORMATION

Orderable Device	Status (1)	Package Type	Package Drawing	Pins	Package Qty	Eco Plan (2)	Lead finish/ Ball material (6)	MSL Peak Temp (3)	Op Temp (°C)	Device Marking (4/5)	Samples
OPA207ID	ACTIVE	SOIC	D	8	75	RoHS & Green	NIPDAU	Level-2-260C-1 YEAR	-40 to 125	OPA207	Samples
OPA207IDBVR	ACTIVE	SOT-23	DBV	5	3000	RoHS & Green	NIPDAUAG	Level-2-260C-1 YEAR	-40 to 125	1NBW	Samples
OPA207IDBVT	ACTIVE	SOT-23	DBV	5	250	RoHS & Green	NIPDAUAG	Level-2-260C-1 YEAR	-40 to 125	1NBW	Samples
OPA207IDGKR	ACTIVE	VSSOP	DGK	8	2500	RoHS & Green	NIPDAUAG	Level-2-260C-1 YEAR	-40 to 125	117Q	Samples
OPA207IDGKT	ACTIVE	VSSOP	DGK	8	250	RoHS & Green	NIPDAUAG	Level-2-260C-1 YEAR	-40 to 125	117Q	Samples
OPA207IDR	ACTIVE	SOIC	D	8	2500	RoHS & Green	NIPDAU	Level-2-260C-1 YEAR	-40 to 125	OPA207	Samples

(1) The marketing status values are defined as follows:

ACTIVE: Product device recommended for new designs.

LIFEBUY: TI has announced that the device will be discontinued, and a lifetime-buy period is in effect.

NRND: Not recommended for new designs. Device is in production to support existing customers, but TI does not recommend using this part in a new design.

PREVIEW: Device has been announced but is not in production. Samples may or may not be available.

OBSOLETE: TI has discontinued the production of the device.

(2) **RoHS:** TI defines "RoHS" to mean semiconductor products that are compliant with the current EU RoHS requirements for all 10 RoHS substances, including the requirement that RoHS substance do not exceed 0.1% by weight in homogeneous materials. Where designed to be soldered at high temperatures, "RoHS" products are suitable for use in specified lead-free processes. TI may reference these types of products as "Pb-Free".

RoHS Exempt: TI defines "RoHS Exempt" to mean products that contain lead but are compliant with EU RoHS pursuant to a specific EU RoHS exemption.

Green: TI defines "Green" to mean the content of Chlorine (Cl) and Bromine (Br) based flame retardants meet JS709B low halogen requirements of <=1000ppm threshold. Antimony trioxide based flame retardants must also meet the <=1000ppm threshold requirement.

(3) MSL, Peak Temp. - The Moisture Sensitivity Level rating according to the JEDEC industry standard classifications, and peak solder temperature.

(4) There may be additional marking, which relates to the logo, the lot trace code information, or the environmental category on the device.

(5) Multiple Device Markings will be inside parentheses. Only one Device Marking contained in parentheses and separated by a "~" will appear on a device. If a line is indented then it is a continuation of the previous line and the two combined represent the entire Device Marking for that device.

(6) Lead finish/Ball material - Orderable Devices may have multiple material finish options. Finish options are separated by a vertical ruled line. Lead finish/Ball material values may wrap to two lines if the finish value exceeds the maximum column width.

Important Information and Disclaimer: The information provided on this page represents TI's knowledge and belief as of the date that it is provided. TI bases its knowledge and belief on information provided by third parties, and makes no representation or warranty as to the accuracy of such information. Efforts are underway to better integrate information from third parties. TI has taken and continues to take reasonable steps to provide representative and accurate information but may not have conducted destructive testing or chemical analysis on incoming materials and chemicals. TI and TI suppliers consider certain information to be proprietary, and thus CAS numbers and other limited information may not be available for release.

In no event shall TI's liability arising out of such information exceed the total purchase price of the TI part(s) at issue in this document sold by TI to Customer on an annual basis.

TAPE AND REEL INFORMATION

QUADRANT ASSIGNMENTS FOR PIN 1 ORIENTATION IN TAPE

*All dimensions are nominal

Device	Package Type	Package Drawing	Pins	SPQ	Reel Diameter (mm)	Reel Width W1 (mm)	A0 (mm)	B0 (mm)	K0 (mm)	P1 (mm)	W (mm)	Pin1 Quadrant
OPA207IDBVR	SOT-23	DBV	5	3000	180.0	8.4	3.23	3.17	1.37	4.0	8.0	Q3
OPA207IDBVT	SOT-23	DBV	5	250	180.0	8.4	3.23	3.17	1.37	4.0	8.0	Q3
OPA207IDGKR	VSSOP	DGK	8	2500	330.0	12.4	5.3	3.4	1.4	8.0	12.0	Q1
OPA207IDGKT	VSSOP	DGK	8	250	330.0	12.4	5.3	3.4	1.4	8.0	12.0	Q1
OPA207IDR	SOIC	D	8	2500	330.0	12.5	6.4	5.2	2.1	8.0	12.0	Q1

TAPE AND REEL BOX DIMENSIONS

*All dimensions are nominal

Device	Package Type	Package Drawing	Pins	SPQ	Length (mm)	Width (mm)	Height (mm)
OPA207IDBVR	SOT-23	DBV	5	3000	213.0	191.0	35.0
OPA207IDBVT	SOT-23	DBV	5	250	213.0	191.0	35.0
OPA207IDGKR	VSSOP	DGK	8	2500	366.0	364.0	50.0
OPA207IDGKT	VSSOP	DGK	8	250	366.0	364.0	50.0
OPA207IDR	SOIC	D	8	2500	340.5	336.1	25.0

TUBE



*All dimensions are nominal

Device	Package Name	Package Type	Pins	SPQ	L (mm)	W (mm)	T (μm)	B (mm)
OPA207ID	D	SOIC	8	75	507	8	3940	4.32

EXAMPLE BOARD LAYOUT

DBV0005A

SOT-23 - 1.45 mm max height

SMALL OUTLINE TRANSISTOR



LAND PATTERN EXAMPLE
EXPOSED METAL SHOWN
SCALE:15X



SOLDER MASK DETAILS

4214839/F 06/2021

NOTES: (continued)

- 5. Publication IPC-7351 may have alternate designs.
- 6. Solder mask tolerances between and around signal pads can vary based on board fabrication site.

EXAMPLE STENCIL DESIGN

DBV0005A

SOT-23 - 1.45 mm max height

SMALL OUTLINE TRANSISTOR



SOLDER PASTE EXAMPLE
BASED ON 0.125 mm THICK STENCIL
SCALE:15X

4214839/F 06/2021

NOTES: (continued)

7. Laser cutting apertures with trapezoidal walls and rounded corners may offer better paste release. IPC-7525 may have alternate design recommendations.
8. Board assembly site may have different recommendations for stencil design.



D0008A

PACKAGE OUTLINE

SOIC - 1.75 mm max height

SMALL OUTLINE INTEGRATED CIRCUIT



4214825/C 02/2019

NOTES:

- Linear dimensions are in inches [millimeters]. Dimensions in parenthesis are for reference only. Controlling dimensions are in inches. Dimensioning and tolerancing per ASME Y14.5M.
- This drawing is subject to change without notice.
- This dimension does not include mold flash, protrusions, or gate burrs. Mold flash, protrusions, or gate burrs shall not exceed $.006$ [0.15] per side.
- This dimension does not include interlead flash.
- Reference JEDEC registration MS-012, variation AA.

EXAMPLE BOARD LAYOUT

D0008A

SOIC - 1.75 mm max height

SMALL OUTLINE INTEGRATED CIRCUIT



LAND PATTERN EXAMPLE
EXPOSED METAL SHOWN
SCALE:8X



SOLDER MASK DETAILS

4214825/C 02/2019

NOTES: (continued)

6. Publication IPC-7351 may have alternate designs.

7. Solder mask tolerances between and around signal pads can vary based on board fabrication site.

EXAMPLE STENCIL DESIGN

D0008A

SOIC - 1.75 mm max height

SMALL OUTLINE INTEGRATED CIRCUIT



SOLDER PASTE EXAMPLE
BASED ON .005 INCH [0.125 MM] THICK STENCIL
SCALE:8X

4214825/C 02/2019

NOTES: (continued)

8. Laser cutting apertures with trapezoidal walls and rounded corners may offer better paste release. IPC-7525 may have alternate design recommendations.
9. Board assembly site may have different recommendations for stencil design.

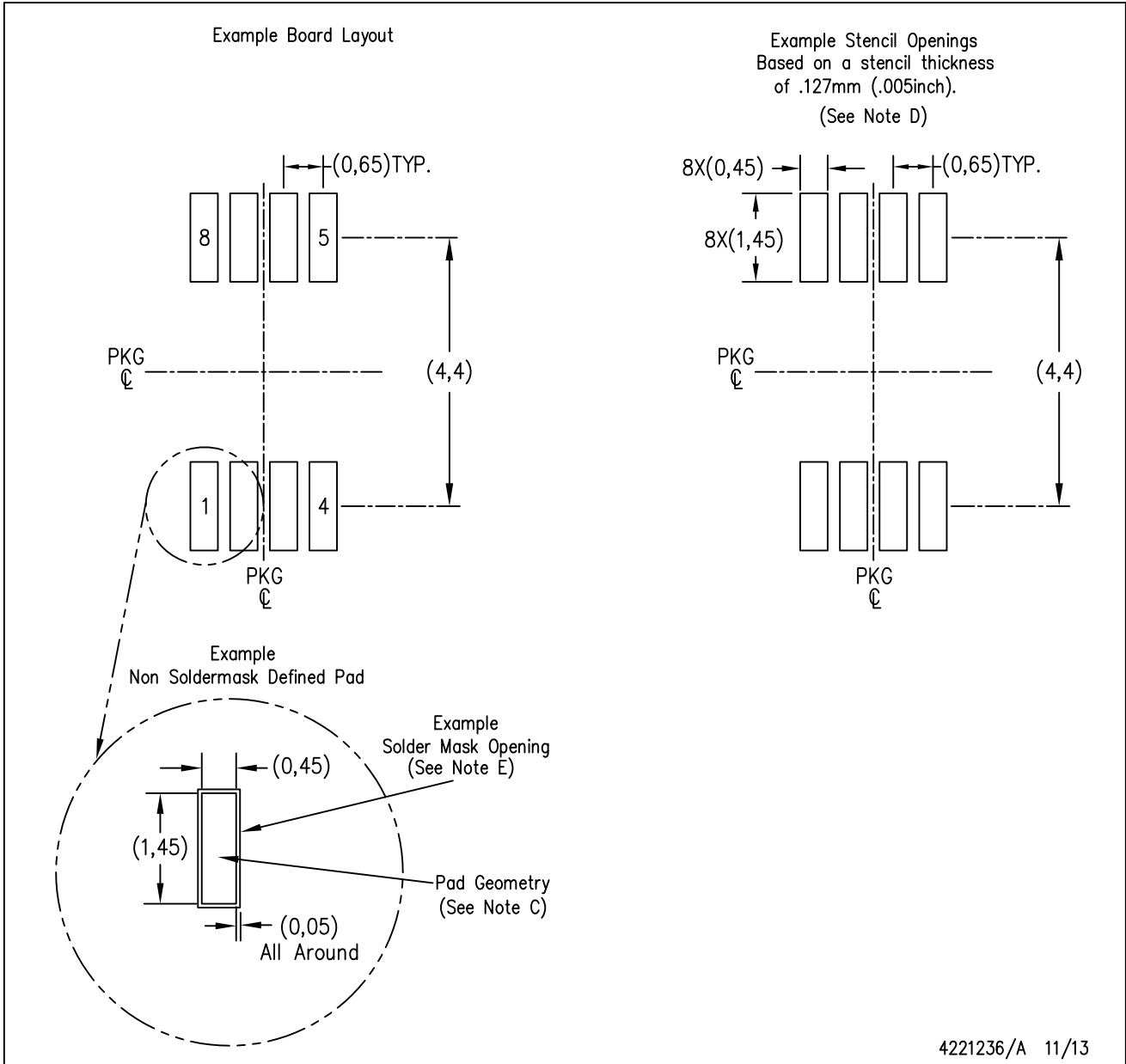

- NOTES:
- A. All linear dimensions are in millimeters.
 - B. This drawing is subject to change without notice.
 - C. Publication IPC-7351 is recommended for alternate designs.
 - D. Laser cutting apertures with trapezoidal walls and also rounding corners will offer better paste release. Customers should contact their board assembly site for stencil design recommendations. Refer to IPC-7525 for other stencil recommendations.
 - E. Customers should contact their board fabrication site for solder mask tolerances between and around signal pads.

IMPORTANT NOTICE AND DISCLAIMER

TI PROVIDES TECHNICAL AND RELIABILITY DATA (INCLUDING DATA SHEETS), DESIGN RESOURCES (INCLUDING REFERENCE DESIGNS), APPLICATION OR OTHER DESIGN ADVICE, WEB TOOLS, SAFETY INFORMATION, AND OTHER RESOURCES "AS IS" AND WITH ALL FAULTS, AND DISCLAIMS ALL WARRANTIES, EXPRESS AND IMPLIED, INCLUDING WITHOUT LIMITATION ANY IMPLIED WARRANTIES OF MERCHANTABILITY, FITNESS FOR A PARTICULAR PURPOSE OR NON-INFRINGEMENT OF THIRD PARTY INTELLECTUAL PROPERTY RIGHTS.

These resources are intended for skilled developers designing with TI products. You are solely responsible for (1) selecting the appropriate TI products for your application, (2) designing, validating and testing your application, and (3) ensuring your application meets applicable standards, and any other safety, security, regulatory or other requirements.

These resources are subject to change without notice. TI grants you permission to use these resources only for development of an application that uses the TI products described in the resource. Other reproduction and display of these resources is prohibited. No license is granted to any other TI intellectual property right or to any third party intellectual property right. TI disclaims responsibility for, and you will fully indemnify TI and its representatives against, any claims, damages, costs, losses, and liabilities arising out of your use of these resources.

TI's products are provided subject to [TI's Terms of Sale](#) or other applicable terms available either on ti.com or provided in conjunction with such TI products. TI's provision of these resources does not expand or otherwise alter TI's applicable warranties or warranty disclaimers for TI products.

TI objects to and rejects any additional or different terms you may have proposed.

Mailing Address: Texas Instruments, Post Office Box 655303, Dallas, Texas 75265
Copyright © 2022, Texas Instruments Incorporated