

## LPV511 Micropower, Rail-to-Rail Input and Output Operational Amplifier

### 1 Features

- Wide Supply Voltage Range: 2.7 V to 12 V
- Slew Rate: 7.7 V/ms
- Supply Current: 880 nA
- Output Short-Circuit Current: 1.35 mA
- Rail-to-Rail Input
- Rail-to-Rail Output: 100 mV from Rails
- Bandwidth ( $C_L = 50$  pF,  $R_L = 1$  M $\Omega$ ): 27 kHz
- Unity Gain Stable

### 2 Applications

- Battery Powered Systems
- Security Systems
- Micropower Thermostats
- Solar Powered Systems
- Portable Instrumentation
- Micropower Filters
- Remote Sensor Amplifiers

### 3 Description

The LPV511 is a micropower operational amplifier that operates from a voltage supply range as wide as 2.7 V to 12 V with ensured specifications at 3 V, 5 V, and 12 V. The ultra-low power LPV511 exhibits an excellent speed to power ratio, drawing only 880 nA of supply current with a bandwidth of 27 kHz. These specifications make the LPV511 an ideal choice for battery-powered systems that require long life through low supply current, such as instrumentation, sensor conditioning and battery current monitoring.

The LPV511 has an input range that includes both supply rails for ground and high-side battery sensing applications. The LPV511 output swings within 100 mV of either rail to maximize the signal's dynamic range in low supply applications. In addition, the output is capable of sourcing 650  $\mu$ A of current when powered by a 12-V battery.

The LPV511 is fabricated on TI's advanced VIP50C process.

The LPV511 is available in the space-saving SC70 package, which makes it ideal for portable electronics with area-constrained PC boards.

#### Device Information<sup>(1)</sup>

PART NUMBER	PACKAGE	BODY SIZE (NOM)
LPV511	SC70 (5)	2.00 mm x 1.25 mm

(1) For all available packages, see the orderable addendum at the end of the data sheet.

Typical Supply Current

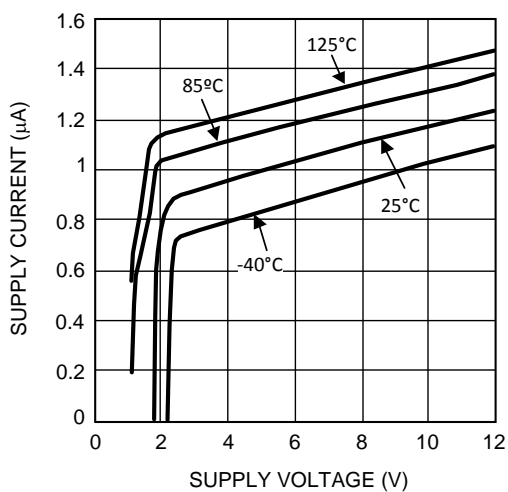

High-Side Battery Current Sensor

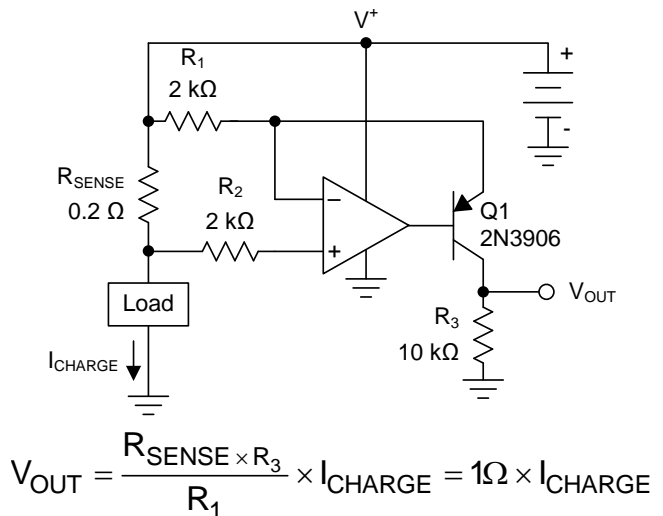

Copyright © 2016, Texas Instruments Incorporated



## Table of Contents

<b>1 Features</b> ..... 1 <b>2 Applications</b> ..... 1 <b>3 Description</b> ..... 1 <b>4 Revision History</b> ..... 2 <b>5 Pin Configuration and Functions</b> ..... 3 <b>6 Specifications</b> ..... 4 6.1 Absolute Maximum Ratings ..... 4 6.2 ESD Ratings..... 4 6.3 Recommended Operating Conditions ..... 4 6.4 Thermal Information ..... 4 6.5 Electrical Characteristics: 3 V ..... 5 6.6 Electrical Characteristics: 5 V ..... 6 6.7 Electrical Characteristics: 12 V ..... 7 6.8 Typical Characteristics ..... 9 <b>7 Detailed Description</b> ..... 14 7.1 Overview ..... 14 7.2 Functional Block Diagram ..... 14 7.3 Feature Description..... 14	7.4 Device Functional Modes..... 14 <b>8 Application and Implementation</b> ..... 16 8.1 Application Information..... 16 8.2 Typical Applications ..... 16 8.3 Dos and Don'ts ..... 17 <b>9 Power Supply Recommendations</b> ..... 18 <b>10 Layout</b> ..... 18 10.1 Layout Guidelines ..... 18 10.2 Layout Example ..... 18 <b>11 Device and Documentation Support</b> ..... 19 11.1 Device Support ..... 19 11.2 Documentation Support ..... 19 11.3 Community Resource..... 19 11.4 Trademarks ..... 19 11.5 Electrostatic Discharge Caution..... 19 11.6 Glossary ..... 19 <b>12 Mechanical, Packaging, and Orderable Information</b> ..... 19
---	--

## 4 Revision History

NOTE: Page numbers for previous revisions may differ from page numbers in the current version.

<b>Changes from Revision C (March 2013) to Revision D</b>	<b>Page</b>
<ul style="list-style-type: none"> <li>• Added <i>ESD Ratings</i> table, <i>Feature Description</i> section, <i>Device Functional Modes</i>, <i>Application and Implementation</i> section, <i>Power Supply Recommendations</i> section, <i>Layout</i> section, <i>Device and Documentation Support</i> section, and <i>Mechanical, Packaging, and Orderable Information</i> section ..... 1</li> <li>• Added <i>Thermal Information</i> table ..... 4</li> </ul>	
<b>Changes from Revision B (March 2013) to Revision C</b>	<b>Page</b>
<ul style="list-style-type: none"> <li>• Changed layout of National Semiconductor Data Sheet to TI format ..... 1</li> </ul>	

## 5 Pin Configuration and Functions

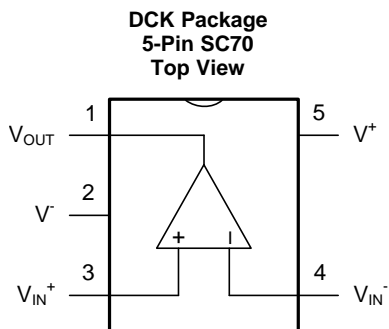

**Pin Functions**

PIN		I/O	DESCRIPTION
NO.	NAME		
1	$V_{OUT}$	O	Output
2	$V^{-}$	P	Negative supply voltage
3	$V_{IN}^{+}$	I	Noninverting input
4	$V_{IN}^{-}$	I	Inverting input
5	$V^{+}$	P	Positive supply voltage

## 6 Specifications

### 6.1 Absolute Maximum Ratings

over operating free-air temperature range (unless otherwise noted)<sup>(1)(2)</sup>

	MIN	MAX	UNIT
V <sub>IN</sub> Differential		2.1	V
Supply voltage (V <sup>+</sup> - V <sup>-</sup> )		13.2	V
Voltage at input and output pins	V <sup>+</sup> + 0.3	V <sup>-</sup> - 0.3	V
Short-circuit duration	See <sup>(3)</sup>		
Junction temperature, T <sub>J</sub> <sup>(4)</sup>		150	°C
Storage temperature, T <sub>stg</sub>	-65	150	°C

- (1) Stresses beyond those listed under *Absolute Maximum Ratings* may cause permanent damage to the device. These are stress ratings only, which do not imply functional operation of the device at these or any other conditions beyond those indicated under *Recommended Operating Conditions*. Exposure to absolute-maximum-rated conditions for extended periods may affect device reliability.
- (2) If Military/Aerospace specified devices are required, contact the Texas Instruments Sales Office/ Distributors for availability and specifications.
- (3) Output short-circuit duration is infinite for V<sup>+</sup> < 6 V at room temperature and below. For V<sup>+</sup> > 6 V, allowable short-circuit duration is 1.5 ms.
- (4) The maximum power dissipation is a function of T<sub>J(MAX)</sub>, R<sub>θJA</sub>, and T<sub>A</sub>. The maximum allowable power dissipation at any ambient temperature is P<sub>D</sub> = (T<sub>J(MAX)</sub> - T<sub>A</sub>) / R<sub>θJA</sub>. All numbers apply for packages soldered directly onto a PC board.

### 6.2 ESD Ratings

		VALUE	UNIT
V <sub>(ESD)</sub> Electrostatic discharge	Human-body model (HBM), per ANSI/ESDA/JEDEC JS-001 <sup>(1)(2)</sup>	±2000	V
	Machine model (MM) <sup>(3)</sup>	±200	

- (1) JEDEC document JEP155 states that 500-V HBM allows safe manufacturing with a standard ESD control process.
- (2) Human Body Model: 1.5 kΩ in series with 100 pF.
- (3) Machine Model: 0 Ω in series with 200 pF.

### 6.3 Recommended Operating Conditions

over operating free-air temperature range (unless otherwise noted)

	MIN	MAX	UNIT
Temperature <sup>(1)</sup>	-40	85	°C
Supply voltage (V <sup>+</sup> - V <sup>-</sup> )	2.7	12	V

- (1) The maximum power dissipation is a function of T<sub>J(MAX)</sub>, R<sub>θJA</sub>, and T<sub>A</sub>. The maximum allowable power dissipation at any ambient temperature is P<sub>D</sub> = (T<sub>J(MAX)</sub> - T<sub>A</sub>) / R<sub>θJA</sub>. All numbers apply for packages soldered directly onto a PC board.

### 6.4 Thermal Information

THERMAL METRIC <sup>(1)</sup>		LPV511	UNIT
		DCK (SC70)	
		5 PINS	
R <sub>θJA</sub>	Junction-to-ambient thermal resistance	278	°C/W
R <sub>θJC(top)</sub>	Junction-to-case (top) thermal resistance	105.8	°C/W
R <sub>θJB</sub>	Junction-to-board thermal resistance	56.4	°C/W
ψ <sub>JT</sub>	Junction-to-top characterization parameter	3	°C/W
ψ <sub>JB</sub>	Junction-to-board characterization parameter	55	°C/W
R <sub>θJC(bot)</sub>	Junction-to-case (bottom) thermal resistance	n/a	°C/W

- (1) For more information about traditional and new thermal metrics, see the [Semiconductor and IC Package Thermal Metrics](#) application report.

## 6.5 Electrical Characteristics: 3 V

Unless otherwise specified, all limits are specified for  $T_J = 25^\circ\text{C}$ ,  $V^+ = 3\text{ V}$ ,  $V^- = 0\text{ V}$ ,  $V_{\text{CM}} = V_O = V^+/2$ , and  $R_L = 100\text{ k}\Omega$  to  $V^+/2$ .<sup>(1)</sup>

PARAMETER		TEST CONDITIONS		MIN <sup>(2)</sup>	TYP <sup>(3)</sup>	MAX <sup>(2)</sup>	UNIT	
$V_{\text{OS}}$	Input offset voltage	$T_J = 25^\circ\text{C}$			$\pm 0.2$	$\pm 3$	mV	
		$T_J = -40^\circ\text{C}$ to $85^\circ\text{C}$				$\pm 3.8$		
TC $V_{\text{OS}}$	Input offset voltage drift <sup>(4)</sup>	$T_J = 25^\circ\text{C}$			$\pm 0.3$		$\mu\text{V}/^\circ\text{C}$	
		$T_J = -40^\circ\text{C}$ to $85^\circ\text{C}$				$\pm 15$		
$I_B$	Input bias current <sup>(5)</sup>	$V_{\text{CM}} = 0.5\text{ V}$	$T_J = 25^\circ\text{C}$	-1000	-320		pA	
			$T_J = -40^\circ\text{C}$ to $85^\circ\text{C}$	-1600				
		$V_{\text{CM}} = 2.5\text{ V}$	$T_J = 25^\circ\text{C}$		110	800		
			$T_J = -40^\circ\text{C}$ to $85^\circ\text{C}$			1900		
$I_{\text{OS}}$	Input offset current				$\pm 10$		pA	
CMRR	Common mode rejection ratio	$V_{\text{CM}}$ Stepped from 0 V to 1.5 V	$T_J = 25^\circ\text{C}$	77	100		dB	
			$T_J = -40^\circ\text{C}$ to $85^\circ\text{C}$	70				
		$V_{\text{CM}}$ Stepped from 2.4 V to 3 V	$T_J = 25^\circ\text{C}$	75	115			
			$T_J = -40^\circ\text{C}$ to $85^\circ\text{C}$	68				
		$V_{\text{CM}}$ Stepped from 0.5 V to 2.5 V	$T_J = 25^\circ\text{C}$	60	80			
			$T_J = -40^\circ\text{C}$ to $85^\circ\text{C}$	56				
PSRR	Power supply rejection ratio	$V^+ = 2.7\text{ V}$ to $5\text{ V}$ , $V_{\text{CM}} = 0.5\text{ V}$	$T_J = 25^\circ\text{C}$	72	114		dB	
			$T_J = -40^\circ\text{C}$ to $85^\circ\text{C}$	68				
		$V^+ = 3\text{ V}$ to $5\text{ V}$ , $V_{\text{CM}} = 0.5\text{ V}$	$T_J = 25^\circ\text{C}$	76	115			
			$T_J = -40^\circ\text{C}$ to $85^\circ\text{C}$	72				
		$V^+ = 5\text{ V}$ to $12\text{ V}$ , $V_{\text{CM}} = 0.5\text{ V}$	$T_J = 25^\circ\text{C}$	84	117			
			$T_J = -40^\circ\text{C}$ to $85^\circ\text{C}$	80				
CMVR	Input common-mode voltage	CMRR $\geq 50\text{ dB}$		$T_J = 25^\circ\text{C}$	-0.1	3.1	V	
				$T_J = -40^\circ\text{C}$ to $85^\circ\text{C}$	0	3		
$A_{\text{VOL}}$	Large signal voltage gain	Sinking, $V_O = 2.5\text{ V}$	$T_J = 25^\circ\text{C}$	75	105		dB	
			$T_J = -40^\circ\text{C}$ to $85^\circ\text{C}$	70				
		Sourcing, $V_O = 0.5\text{ V}$	$T_J = 25^\circ\text{C}$	75	105			
			$T_J = -40^\circ\text{C}$ to $85^\circ\text{C}$	70				
$V_O$	Output swing high	$V_{\text{ID}} = 100\text{ mV}$	$T_J = 25^\circ\text{C}$	2.85	2.9		V	
			$T_J = -40^\circ\text{C}$ to $85^\circ\text{C}$	2.8				
	Output swing low	$V_{\text{ID}} = -100\text{ mV}$	$T_J = 25^\circ\text{C}$		100	150		
			$T_J = -40^\circ\text{C}$ to $85^\circ\text{C}$			200		
$I_{\text{SC}}$	Output short circuit current <sup>(6)</sup>	Sourcing $V_{\text{ID}} = 100\text{ mV}$		-500	-225		$\mu\text{A}$	
		Sinking $V_{\text{ID}} = -100\text{ mV}$		225	1350			
$I_S$	Supply current	$T_J = 25^\circ\text{C}$			0.88	1.2	$\mu\text{A}$	
		$T_J = -40^\circ\text{C}$ to $85^\circ\text{C}$				1.5		
SR	Slew rate <sup>(7)</sup>	$A_V = 1$ , $V_O$ ramps from 0.5 V to 2.5 V	$T_J = 25^\circ\text{C}$	5.25	7.7		V/ms	
			$T_J = -40^\circ\text{C}$ to $85^\circ\text{C}$	3.10				

- (1) Electrical table values apply only for factory testing conditions at the temperature indicated. Factory testing conditions result in very limited self-heating of the device.
- (2) Limits are 100% production tested at  $25^\circ\text{C}$ . Limits over the operating temperature range are specified through correlations using the Statistical Quality Control (SQC) method.
- (3) Typical values represent the most likely parametric norm at the time of characterization.
- (4) Offset voltage drift is specified by design and/or characterization and is not tested in production. Offset voltage drift is determined by dividing the change in VOS at temperature extremes into the total temperature change.
- (5) Positive current corresponds to current flowing into the device.
- (6) The Short-Circuit Test is a momentary test. See Note 3 in [Absolute Maximum Ratings](#).
- (7) Slew rate is the average of the rising and falling slew rates.

### Electrical Characteristics: 3 V (continued)

Unless otherwise specified, all limits are specified for  $T_J = 25^\circ\text{C}$ ,  $V^+ = 3\text{ V}$ ,  $V^- = 0\text{ V}$ ,  $V_{CM} = V_O = V^+/2$ , and  $R_L = 100\text{ k}\Omega$  to  $V^+/2$ .<sup>(1)</sup>

PARAMETER		TEST CONDITIONS	MIN <sup>(2)</sup>	TYP <sup>(3)</sup>	MAX <sup>(2)</sup>	UNIT
GBW	Gain bandwidth product	$R_L = 1\text{ M}\Omega$ , $C_L = 50\text{ pF}$		27		kHz
	Phase margin	$R_L = 1\text{ M}\Omega$ , $C_L = 50\text{ pF}$		53		°
$e_n$	Input-referred voltage noise	$f = 100\text{ Hz}$		320		$\text{nV}/\sqrt{\text{Hz}}$
$i_n$	Input-referred current noise	$f = 10\text{ Hz}$		0.02		$\mu\text{A}/\sqrt{\text{Hz}}$
		$f = 1\text{ kHz}$		0.01		

### 6.6 Electrical Characteristics: 5 V

Unless otherwise specified, all limits are specified for  $T_J = 25^\circ\text{C}$ ,  $V^+ = 5\text{ V}$ ,  $V^- = 0\text{ V}$ ,  $V_{CM} = V_O = V^+/2$ , and  $R_L = 100\text{ k}\Omega$  to  $V^+/2$ .<sup>(1)</sup>

PARAMETER		TEST CONDITIONS	MIN <sup>(2)</sup>	TYP <sup>(3)</sup>	MAX <sup>(2)</sup>	UNIT	
$V_{OS}$	Input offset voltage	$T_J = 25^\circ\text{C}$		$\pm 0.2$	$\pm 3$	mV	
		$T_J = -40^\circ\text{C}$ to $85^\circ\text{C}$			$\pm 3.8$		
TC $V_{OS}$	Input offset voltage drift <sup>(4)</sup>	$T_J = 25^\circ\text{C}$		$\pm 0.3$		$\mu\text{V}/^\circ\text{C}$	
		$T_J = -40^\circ\text{C}$ to $85^\circ\text{C}$			$\pm 15$		
$I_B$	Input bias current <sup>(5)</sup>	$V_{CM} = 0.5\text{ V}$	$T_J = 25^\circ\text{C}$	-1000	-320	pA	
			$T_J = -40^\circ\text{C}$ to $85^\circ\text{C}$	-1600			
		$V_{CM} = 4.5\text{ V}$	$T_J = 25^\circ\text{C}$		110		800
			$T_J = -40^\circ\text{C}$ to $85^\circ\text{C}$				1900
$I_{OS}$	Input offset current			$\pm 10$	pA		
CMRR	Common mode rejection ratio	$V_{CM}$ Stepped from 0 V to 2.5 V	$T_J = 25^\circ\text{C}$	80	115	dB	
			$T_J = -40^\circ\text{C}$ to $85^\circ\text{C}$	73			
		$V_{CM}$ Stepped from 4.4 to 5 V	$T_J = 25^\circ\text{C}$	75	107		
			$T_J = -40^\circ\text{C}$ to $85^\circ\text{C}$	68			
PSRR	Power supply rejection ratio	$V^+ = 2.7\text{ V}$ to $5\text{ V}$ , $V_{CM} = 0.5\text{ V}$	$T_J = 25^\circ\text{C}$	72	114	dB	
			$T_J = -40^\circ\text{C}$ to $85^\circ\text{C}$	68			
		$V^+ = 3\text{ V}$ to $5\text{ V}$ , $V_{CM} = 0.5\text{ V}$	$T_J = 25^\circ\text{C}$	76	115		
			$T_J = -40^\circ\text{C}$ to $85^\circ\text{C}$	72			
CMVR	Input common-mode voltage	CMRR $\geq 50\text{ dB}$	$T_J = 25^\circ\text{C}$	-0.1	5.1	V	
			$T_J = -40^\circ\text{C}$ to $85^\circ\text{C}$	0	5		
		Sinking, $V_O = 4.5\text{ V}$	$T_J = 25^\circ\text{C}$	78	110		
			$T_J = -40^\circ\text{C}$ to $85^\circ\text{C}$	73			
$A_{VOL}$	Large signal voltage gain	Sourcing, $V_O = 0.5\text{ V}$	$T_J = 25^\circ\text{C}$	78	110	dB	
			$T_J = -40^\circ\text{C}$ to $85^\circ\text{C}$	73			

- (1) Electrical table values apply only for factory testing conditions at the temperature indicated. Factory testing conditions result in very limited self-heating of the device.
- (2) Limits are 100% production tested at  $25^\circ\text{C}$ . Limits over the operating temperature range are specified through correlations using the Statistical Quality Control (SQC) method.
- (3) Typical values represent the most likely parametric norm at the time of characterization.
- (4) Offset voltage drift is specified by design and/or characterization and is not tested in production. Offset voltage drift is determined by dividing the change in  $V_{OS}$  at temperature extremes into the total temperature change.
- (5) Positive current corresponds to current flowing into the device.

## Electrical Characteristics: 5 V (continued)

Unless otherwise specified, all limits are specified for  $T_J = 25^\circ\text{C}$ ,  $V^+ = 5\text{ V}$ ,  $V^- = 0\text{ V}$ ,  $V_{\text{CM}} = V_O = V^+/2$ , and  $R_L = 100\text{ k}\Omega$  to  $V^+/2$ .<sup>(1)</sup>

PARAMETER		TEST CONDITIONS		MIN <sup>(2)</sup>	TYP <sup>(3)</sup>	MAX <sup>(2)</sup>	UNIT
$V_O$	Output swing high	$V_{\text{ID}} = 100\text{ mV}$	$T_J = 25^\circ\text{C}$	4.8	4.89		V
			$T_J = -40^\circ\text{C}$ to $85^\circ\text{C}$	4.75			
	Output swing low	$V_{\text{ID}} = -100\text{ mV}$	$T_J = 25^\circ\text{C}$		110	200	mV
			$T_J = -40^\circ\text{C}$ to $85^\circ\text{C}$			250	
$I_{\text{SC}}$	Output short circuit current <sup>(6)</sup>	Sourcing to $V^-$ $V_{\text{ID}} = 100\text{ mV}$			-550	-225	$\mu\text{A}$
		Sinking to $V^+$ $V_{\text{ID}} = -100\text{ mV}$		225	1350		
$I_S$	Supply current	$T_J = 25^\circ\text{C}$		0.97	1.2	$\mu\text{A}$	
		$T_J = -40^\circ\text{C}$ to $85^\circ\text{C}$			1.5		
SR	Slew rate <sup>(7)</sup>	$A_V = 1$ , $V_O$ ramps from 0.5 V to 4.5 V	$T_J = 25^\circ\text{C}$	5.25	7.5	V/ms	
			$T_J = -40^\circ\text{C}$ to $85^\circ\text{C}$	3.1			
GBW	Gain bandwidth product	$R_L = 1\text{ M}\Omega$ , $C_L = 50\text{ pF}$		27		kHz	
	Phase margin	$R_L = 1\text{ M}\Omega$ , $C_L = 50\text{ pF}$		53		°	
$e_n$	Input-referred voltage noise	$f = 100\text{ Hz}$		320		$\text{nV}/\sqrt{\text{Hz}}$	
$i_n$	Input-referred current noise	$f = 10\text{ Hz}$		0.02		$\text{pA}/\sqrt{\text{Hz}}$	
		$f = 1\text{ kHz}$		0.01			

(6) The Short-Circuit Test is a momentary test. See Note 3 in [Absolute Maximum Ratings](#).

(7) Slew rate is the average of the rising and falling slew rates.

## 6.7 Electrical Characteristics: 12 V

Unless otherwise specified, all limits are specified for  $T_J = 25^\circ\text{C}$ ,  $V^+ = 12\text{ V}$ ,  $V^- = 0\text{ V}$ ,  $V_{\text{CM}} = V_O = V^+/2$ , and  $R_L = 100\text{ k}\Omega$  to  $V^+/2$ .<sup>(1)</sup>

PARAMETER		TEST CONDITIONS		MIN <sup>(2)</sup>	TYP <sup>(3)</sup>	MAX <sup>(2)</sup>	UNIT
$V_{\text{OS}}$	Input offset voltage	$T_J = 25^\circ\text{C}$			$\pm 0.2$	$\pm 3$	mV
		$T_J = -40^\circ\text{C}$ to $85^\circ\text{C}$				$\pm 3.8$	
TC $V_{\text{OS}}$	Input offset voltage drift <sup>(4)</sup>	$T_J = 25^\circ\text{C}$			$\pm 0.3$		$\mu\text{V}/^\circ\text{C}$
		$T_J = -40^\circ\text{C}$ to $85^\circ\text{C}$				$\pm 15$	
$I_B$	Input bias current <sup>(5)</sup>	$V_{\text{CM}} = 0.5\text{ V}$	$T_J = 25^\circ\text{C}$	-1000	-320		$\text{pA}$
			$T_J = -40^\circ\text{C}$ to $85^\circ\text{C}$	-1600			
		$V_{\text{CM}} = 11.5\text{ V}$	$T_J = 25^\circ\text{C}$		110	800	
			$T_J = -40^\circ\text{C}$ to $85^\circ\text{C}$			1900	
$I_{\text{OS}}$	Input offset current				$\pm 10$	$\text{pA}$	
CMRR	Common mode rejection ratio	$V_{\text{CM}}$ Stepped from 0 V to 6 V	$T_J = 25^\circ\text{C}$	75	115	dB	
			$T_J = -40^\circ\text{C}$ to $85^\circ\text{C}$	70			
		$V_{\text{CM}}$ Stepped from 11.4 V to 12 V	$T_J = 25^\circ\text{C}$	75	110		
			$T_J = -40^\circ\text{C}$ to $85^\circ\text{C}$	68			
		$V_{\text{CM}}$ Stepped from 0.5 V to 11.5 V	$T_J = 25^\circ\text{C}$	70	97		
			$T_J = -40^\circ\text{C}$ to $85^\circ\text{C}$	65			

(1) Electrical table values apply only for factory testing conditions at the temperature indicated. Factory testing conditions result in very limited self-heating of the device.

(2) Limits are 100% production tested at  $25^\circ\text{C}$ . Limits over the operating temperature range are specified through correlations using the Statistical Quality Control (SQC) method.

(3) Typical values represent the most likely parametric norm at the time of characterization.

(4) Offset voltage drift is specified by design and/or characterization and is not tested in production. Offset voltage drift is determined by dividing the change in VOS at temperature extremes into the total temperature change.

(5) Positive current corresponds to current flowing into the device.

**Electrical Characteristics: 12 V (continued)**

Unless otherwise specified, all limits are specified for  $T_J = 25^\circ\text{C}$ ,  $V^+ = 12\text{ V}$ ,  $V^- = 0\text{ V}$ ,  $V_{\text{CM}} = V_O = V^+/2$ , and  $R_L = 100\text{ k}\Omega$  to  $V^+/2$ .<sup>(1)</sup>

PARAMETER		TEST CONDITIONS	MIN <sup>(2)</sup>	TYP <sup>(3)</sup>	MAX <sup>(2)</sup>	UNIT	
PSRR	Power supply rejection ratio	$V^+ = 2.7\text{ V to }5\text{ V}$ , $V_{\text{CM}} = 0.5\text{ V}$	$T_J = 25^\circ\text{C}$	72	114		
			$T_J = -40^\circ\text{C to }85^\circ\text{C}$	68			
		$V^+ = 3\text{ V to }5\text{ V}$ , $V_{\text{CM}} = 0.5\text{ V}$	$T_J = 25^\circ\text{C}$	76	115		
			$T_J = -40^\circ\text{C to }85^\circ\text{C}$	72			
$V^+ = 5\text{ V to }12\text{ V}$ , $V_{\text{CM}} = 0.5\text{ V}$	$T_J = 25^\circ\text{C}$	84	117				
	$T_J = -40^\circ\text{C to }85^\circ\text{C}$	80					
CMVR	Input common-mode voltage	CMRR $\geq 50\text{ dB}$	$T_J = 25^\circ\text{C}$	-0.1	12.1	V	
			$T_J = -40^\circ\text{C to }85^\circ\text{C}$	0	12		
A <sub>VOL</sub>	Large signal voltage gain	Sinking, $V_O = 0.5\text{ V}$	$T_J = 25^\circ\text{C}$	89	110	dB	
			$T_J = -40^\circ\text{C to }85^\circ\text{C}$	84			
		Sourcing, $V_O = 11.5\text{ V}$	$T_J = 25^\circ\text{C}$	89	110		
			$T_J = -40^\circ\text{C to }85^\circ\text{C}$	84			
V <sub>O</sub>	Output swing high	$V_{\text{ID}} = 100\text{ mV}$	$T_J = 25^\circ\text{C}$	11.8	11.85	V	
			$T_J = -40^\circ\text{C to }85^\circ\text{C}$	11.72			
	Output swing low	$V_{\text{ID}} = -100\text{ mV}$	$T_J = 25^\circ\text{C}$		150	200	mV
			$T_J = -40^\circ\text{C to }85^\circ\text{C}$			280	
I <sub>SC</sub>	Output short circuit current <sup>(6)</sup>	Sourcing $V_{\text{ID}} = 100\text{ mV}$		-650	-200	$\mu\text{A}$	
		Sinking $V_{\text{ID}} = -100\text{ mV}$	200	1300			
I <sub>S</sub>	Supply current	$T_J = 25^\circ\text{C}$		1.2	1.75	$\mu\text{A}$	
		$T_J = -40^\circ\text{C to }85^\circ\text{C}$			2.5		
SR	Slew rate <sup>(7)</sup>	$A_V = 1$ , $V_O$ ramped from 1 V to 11 V		5.25	7	V/ms	
				3.1			
GBW	Gain bandwidth product	$R_L = 1\text{ M}\Omega$ , $C_L = 50\text{ pF}$		25		kHz	
	Phase margin	$R_L = 1\text{ M}\Omega$ , $C_L = 50\text{ pF}$		52		°	
e <sub>n</sub>	Input-referred voltage noise	$f = 100\text{ Hz}$		320		nV/ $\sqrt{\text{Hz}}$	
i <sub>n</sub>	Input-referred current noise	$f = 10\text{ Hz}$		0.02		pA/ $\sqrt{\text{Hz}}$	
		$f = 1\text{ kHz}$		0.01			

(6) The Short-Circuit Test is a momentary test. See Note 3 in [Absolute Maximum Ratings](#).

(7) Slew rate is the average of the rising and falling slew rates.



## 6.8 Typical Characteristics

At  $T_J = 25^\circ\text{C}$ , unless otherwise specified.

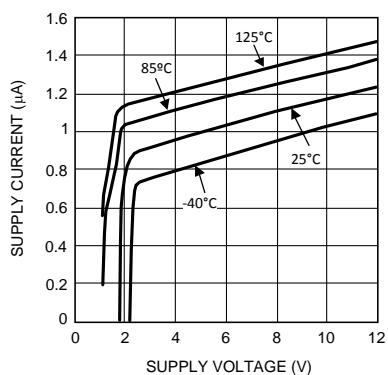

Figure 1. Supply Current vs Supply Voltage

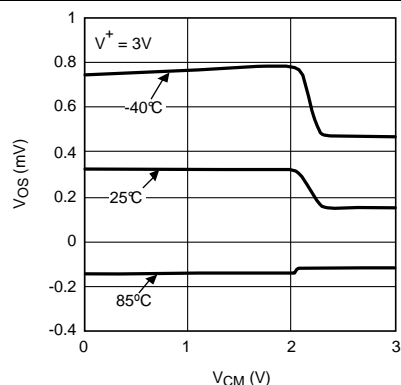

Figure 2. Input Offset Voltage vs Input Common Mode

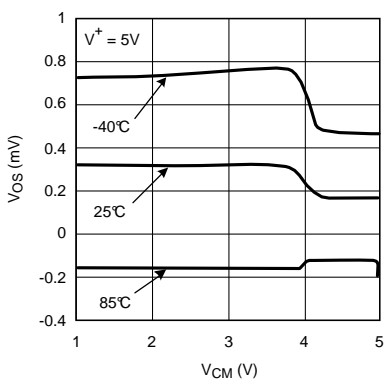

Figure 3. Input Offset Voltage vs Input Common Mode

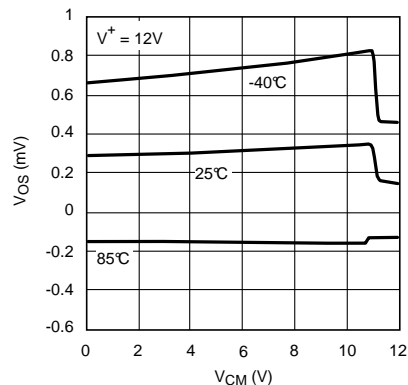

Figure 4. Input Offset Voltage vs Input Common Mode

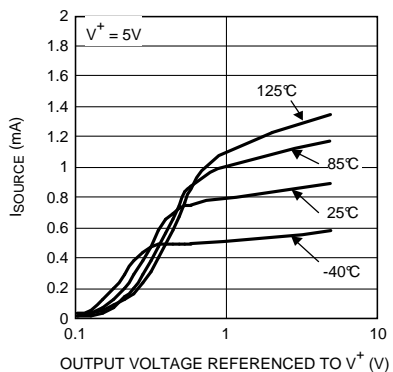

Figure 5. Sourcing Current vs Output Voltage

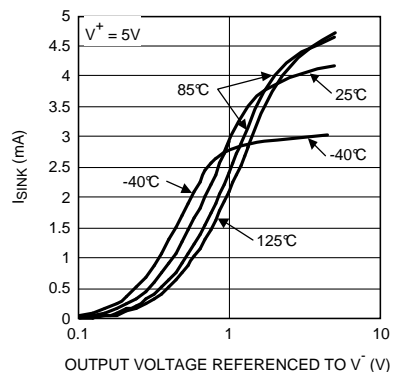

Figure 6. Sinking Current vs Output Voltage

### Typical Characteristics (continued)

At  $T_J = 25^\circ\text{C}$ , unless otherwise specified.

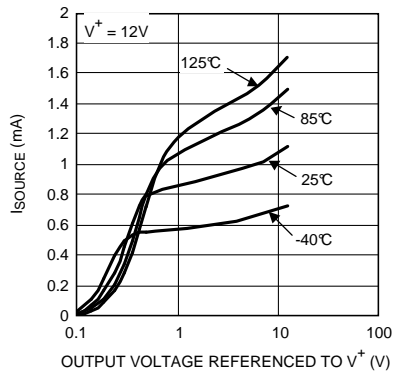

Figure 7. Sourcing Current vs Output Voltage

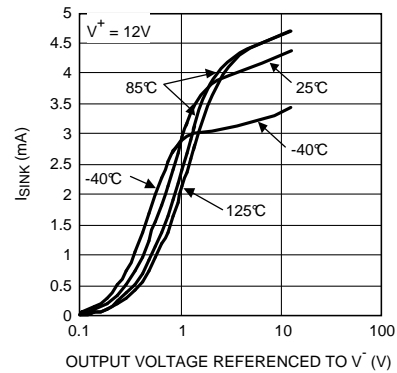

Figure 8. Sinking Current vs Output Voltage

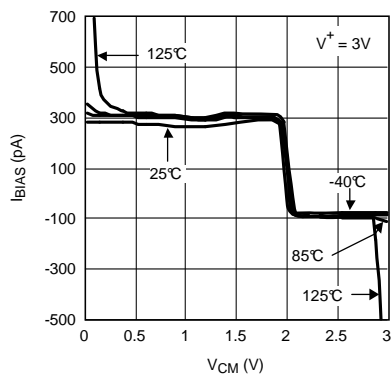

Figure 9. Input Bias Current vs Common Mode Voltage

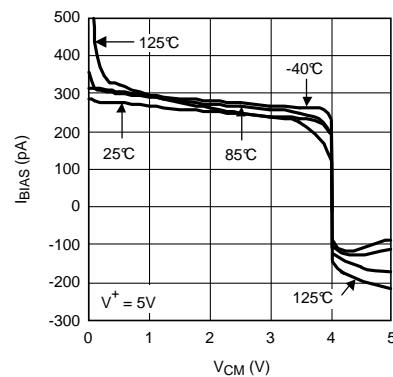

Figure 10. Input Bias Current vs Common Mode Voltage

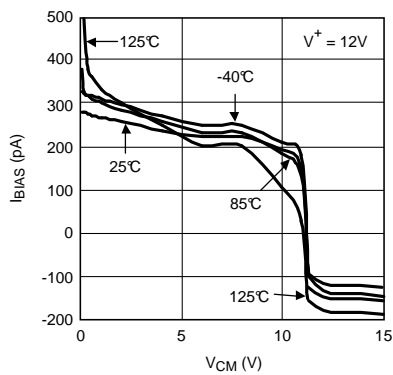

Figure 11. Input Bias Current vs Common Mode Voltage

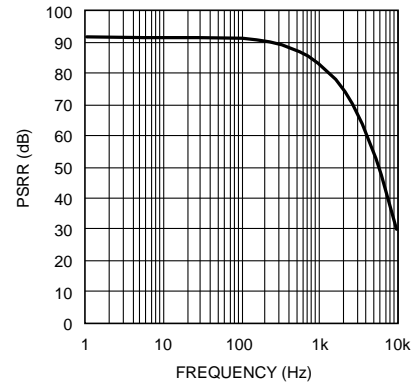

Figure 12. PSRR vs Frequency

Typical Characteristics (continued)

At  $T_J = 25^\circ\text{C}$ , unless otherwise specified.

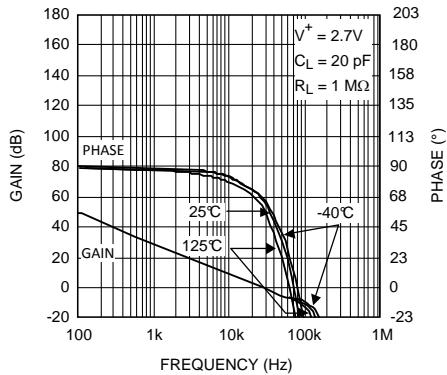

Figure 13. Frequency Response vs Temperature

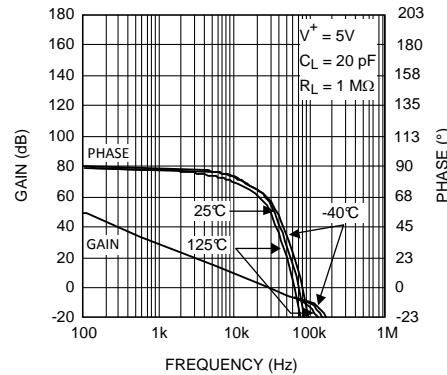

Figure 14. Frequency Response vs Temperature

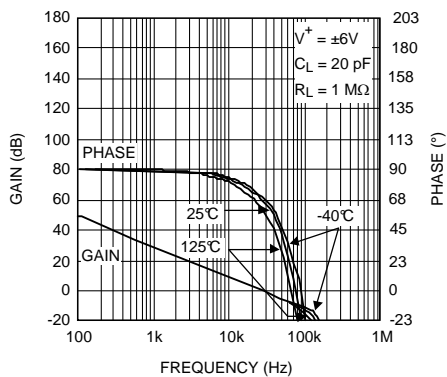

Figure 15. Frequency Response vs Temperature

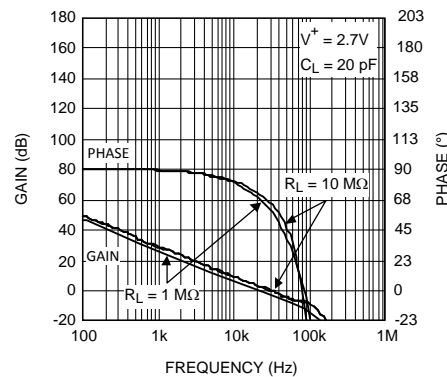

Figure 16. Frequency Response vs  $R_L$

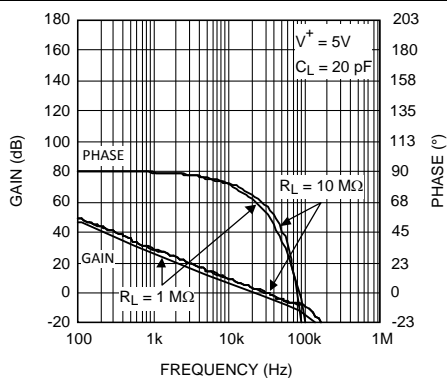

Figure 17. Frequency Response vs  $R_L$

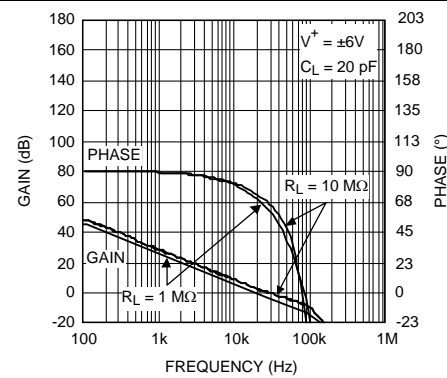

Figure 18. Frequency Response vs  $R_L$

Typical Characteristics (continued)

At  $T_J = 25^\circ\text{C}$ , unless otherwise specified.

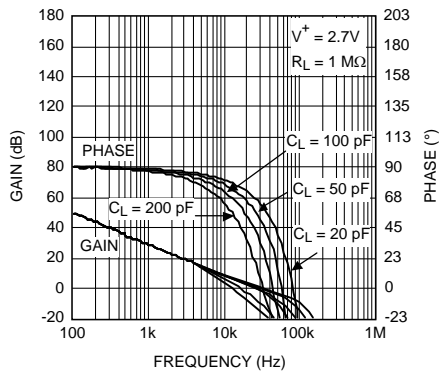

Figure 19. Frequency Response vs  $C_L$

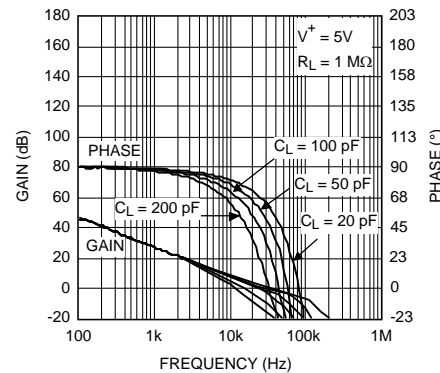

Figure 20. Frequency Response vs  $C_L$

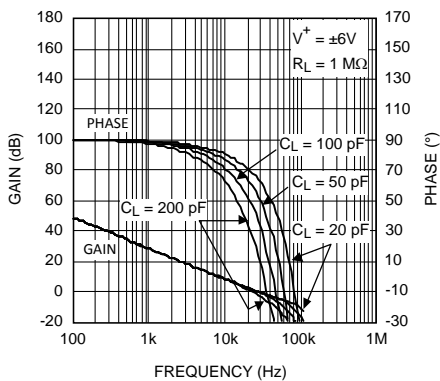

Figure 21. Frequency Response vs  $C_L$

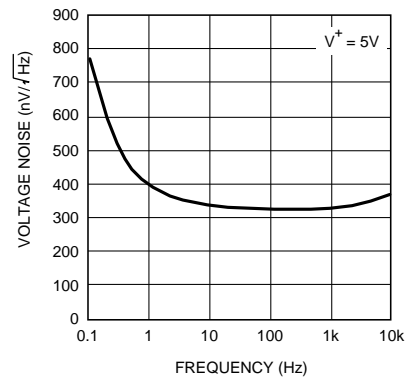

Figure 22. Voltage Noise vs Frequency

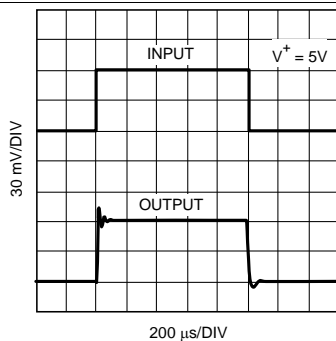

Figure 23. Noninverting Small-Signal Pulse Response

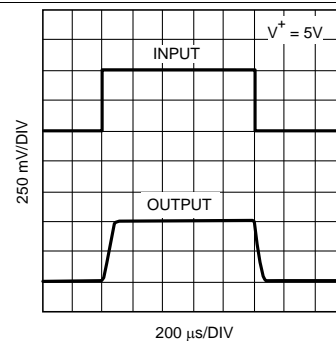
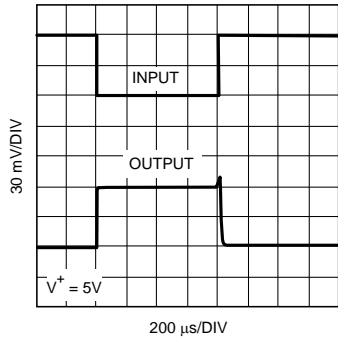

Figure 24. Noninverting Large-Signal Pulse Response

**Typical Characteristics (continued)**

At  $T_J = 25^\circ\text{C}$ , unless otherwise specified.



**Figure 25. Inverting Small-Signal Pulse Response**

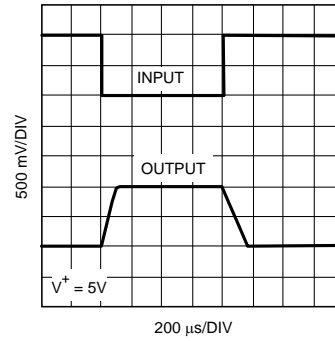

**Figure 26. Inverting Large-Signal Pulse Response**

## 7 Detailed Description

### 7.1 Overview

The LPV511 is a micropower operational amplifier that operates from a voltage supply range as wide as 2.7 V to 12 V with ensured specifications at 3 V, 5 V, and 12 V. The LPV511 exhibits an excellent speed-to-power ratio, drawing only 880 nA of supply current with a bandwidth of 27 kHz.

### 7.2 Functional Block Diagram

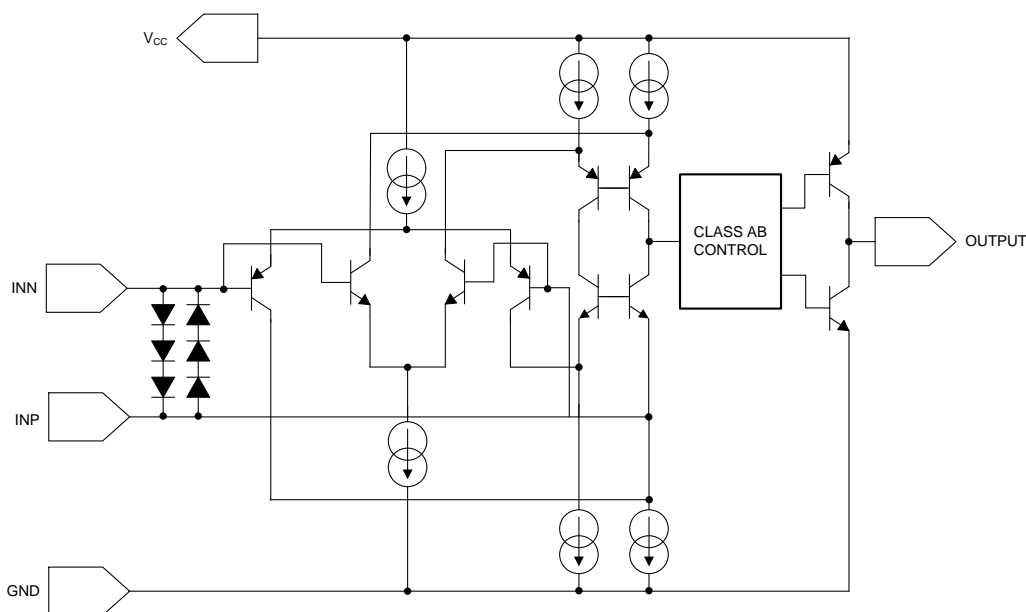

Copyright © 2016, Texas Instruments Incorporated

### 7.3 Feature Description

The LPV511 has a rail-to-rail input which provides more flexibility for the system designer. As can be seen from [Functional Block Diagram](#), rail-to-rail input is achieved by using in parallel, one PNP differential pair and one NPN differential pair. When the common mode input voltage ( $V_{CM}$ ) is near  $V^+$ , the NPN pair is on and the PNP pair is off. When  $V_{CM}$  is near  $V^-$ , the NPN pair is off and the PNP pair is on. When  $V_{CM}$  is between  $V^+$  and  $V^-$ , internal logic decides how much current each differential pair will get. This special logic ensures stable and low distortion amplifier operation within the entire common mode voltage range.

### 7.4 Device Functional Modes

#### 7.4.1 Input Stage

Because both input stages have their own offset voltage ( $V_{OS}$ ) characteristic, the offset voltage of the LPV511 becomes a function of  $V_{CM}$ .  $V_{OS}$  has a crossover point at 1 V below  $V^+$ . See the  $V_{OS}$  vs  $V_{CM}$  curve in [Typical Characteristics](#). Caution must be taken in situations where the input signal amplitude is comparable to the  $V_{OS}$  value and/or the design requires high accuracy. In these situations, it is necessary for the input signal to avoid the crossover point.

The input bias current,  $I_B$  will change in value and polarity as the input crosses the transition region. In addition, parameters such as PSRR and CMRR which involve the input offset voltage will also be affected by changes in  $V_{CM}$  across the differential pair transition region.

Differential input voltage is the difference in voltage between the noninverting (+) input and the inverting input (-) of the op amp. Due to the three series diodes across the two inputs, the absolute maximum differential input voltage is  $\pm 2.1$  V. This may not be a problem to most conventional op amp designs; however, designers **must avoid using the LPV511 as a comparator**.

## Device Functional Modes (continued)

### 7.4.2 Output Stage

The LPV511 output voltage swing 100 mV from rails at 3-V supply, which provides the maximum possible dynamic range at the output. This is particularly important when operating on low supply voltages.

The LPV511 maximum output voltage swing defines the maximum swing possible under a particular output load. The LPV511 output swings 110 mV from the rail at 5-V supply with an output load of 100 k $\Omega$ .

### 7.4.3 Driving Capacitive Load

The LPV511 is internally compensated for stable unity gain operation, with a 27-kHz typical gain bandwidth. However, the unity gain follower is the most sensitive configuration to capacitive load. Direct capacitive loading reduces the phase margin of the op amp. When the output is required to drive a large capacitive load, greater than 100 pF, a small series resistor at the output of the amplifier improves the phase margin (see [Figure 27](#)).

In [Figure 27](#), the isolation resistor  $R_{ISO}$  and the load capacitor  $C_L$  form a pole to increase stability by adding more phase margin to the overall system. The desired performance depends on the value of  $R_{ISO}$ . The bigger the  $R_{ISO}$  resistor value, the more stable  $V_{OUT}$  will be. But the DC accuracy is degraded when the  $R_{ISO}$  gets bigger. If there were a load resistor in [Figure 27](#), the output voltage would be divided by  $R_{ISO}$  and the load resistor.

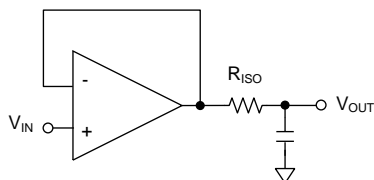

Copyright © 2016, Texas Instruments Incorporated

**Figure 27. Resistive Isolation of Capacitive Load**

## 8 Application and Implementation

### NOTE

Information in the following applications sections is not part of the TI component specification, and TI does not warrant its accuracy or completeness. TI's customers are responsible for determining suitability of components for their purposes. Customers should validate and test their design implementation to confirm system functionality.

### 8.1 Application Information

The LPV511 is fabricated with Texas Instrument's state-of-the-art VIP50C process.

### 8.2 Typical Applications

#### 8.2.1 Battery Current Sensing

The rail-to-rail common mode input range and the very low quiescent current make the LPV511 ideal to use in high-side and low-side battery current sensing applications. The high-side current sensing circuit in [Figure 28](#) is commonly used in a battery charger to monitor the charging current to prevent over charging. A sense resistor  $R_{SENSE}$  is connected to the battery directly.

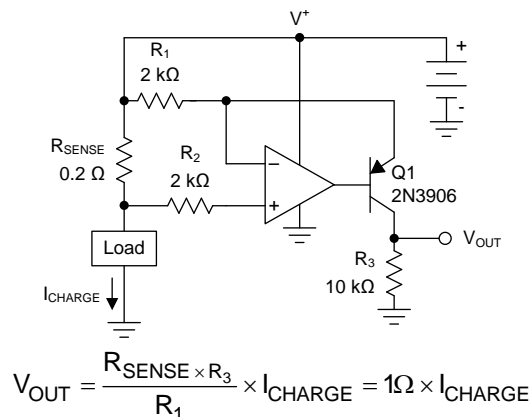

Copyright © 2016, Texas Instruments Incorporated

**Figure 28. High Side Current Sensing**

##### 8.2.1.1 Design Requirements

The high-side current-sensing circuit ([Figure 28](#)) is commonly used in a battery charger to monitor charging current to prevent overcharging. A sense resistor  $R_{SENSE}$  is connected to the battery directly. This system requires an op amp with rail-to-rail input. The LPV511 is ideal for this application because its common-mode input range extends up to the positive supply.

##### 8.2.1.2 Detailed Design Procedure

As seen in [Figure 28](#), the  $I_{CHARGE}$  current flowing through sense resistor  $R_{SENSE}$  develops a voltage drop equal to  $V_{SENSE}$ . The voltage at the negative sense point will now be less than the positive sense point by an amount proportional to the  $V_{SENSE}$  voltage.

The low-bias currents of the LPV511 cause little voltage drop through  $R_2$ , so the negative input of the LPV511 amplifier is at essentially the same potential as the negative sense input.

The LPV511 will detect this voltage error between its inputs and servo the transistor base to conduct more current through Q1, increasing the voltage drop across  $R_1$  until the LPV511 inverting input matches the noninverting input. At this point, the voltage drop across  $R_1$  now matches  $V_{SENSE}$ .

$I_G$ , a current proportional to  $I_{CHARGE}$ , will flow according to the following relation to:

$$I_G = V_{R_{SENSE}} / R_1 = (R_{SENSE} \times I_{CHARGE}) / R_1 \quad (1)$$



## Typical Applications (continued)

$I_G$  also flows through the gain resistor  $R_3$  developing a voltage drop equal to:

$$V_3 = I_G \times R_3 = (V_{RSENSE} / R_1) \times R_3 = ((R_{SENSE} \times I_{CHARGE}) / R_2) \times R_3 \quad (2)$$

$$V_{OUT} = (R_{SENSE} \times I_{CHARGE}) \times G$$

where

- $G = R_3 / R_1$  (3)

### 8.2.1.3 Application Curve

Figure 29 shows the results of the example current sense circuit.

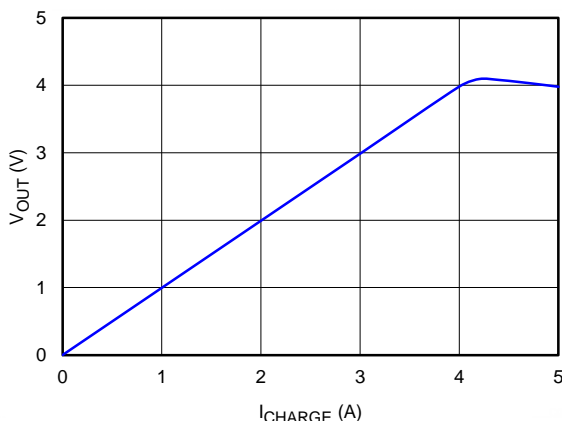

The error after 4 V where transistor Q1 runs out of headroom and saturates, limiting the upper output swing.

**Figure 29. Current Sense Amplifier Results**

### 8.2.2 Summing Amplifier

The LPV511 operational amplifier is a perfect fit in a summing amplifier circuit because of the rail-to-rail input and output and the sub-micro Amp quiescent current. In this configuration, the amplifier outputs the sum of the three input voltages.

Equation 4 shows the ratio of the sum and the output voltage is defined using feedback and input resistors.

$$V_{OUT} = R_F \left( \frac{V_{REF} - V_1}{R_1} + \frac{V_{REF} - V_2}{R_2} + \frac{V_{REF} - V_3}{R_3} \right) + V_{REF} \quad (4)$$

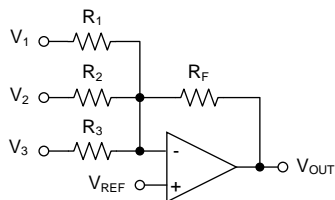

Copyright © 2016, Texas Instruments Incorporated

**Figure 30. Summing Amplifier Circuit**

## 8.3 Dos and Don'ts

Do properly bypass the power supplies.

Do add series resistance to the output when driving capacitive loads, particularly cables, Muxes and ADC inputs.

Do add series current limiting resistors and external Schottky clamp diodes if input voltage is expected to exceed the supplies. Limit the current to 1 mA or less (1 kΩ per volt).

## 9 Power Supply Recommendations

The LPV80x is specified for operation from 1.6 V to 5.5 V ( $\pm 0.8$  V to  $\pm 2.75$  V) over a  $-40^{\circ}\text{C}$  to  $125^{\circ}\text{C}$  temperature range. Parameters that can exhibit significant variance with regard to operating voltage or temperature are presented in the [Electrical Characteristics: 3 V](#).

### CAUTION

Supply voltages larger than 13.2 V can permanently damage the device.

For proper operation, the power supplies must be properly decoupled. For decoupling the supply lines it is suggested that 100 nF capacitors be placed as close as possible to the operational amplifier power supply pins. For single supply, place a capacitor between  $V^+$  and  $V^-$  supply leads. For dual supplies, place one capacitor between  $V^+$  and ground, and one capacitor between  $V^-$  and ground.

Low bandwidth nanopower devices do not have good high frequency ( $> 1$  kHz) AC PSRR rejection against high-frequency switching supplies and other 1 kHz and above noise sources, so extra supply filtering is recommended if kilohertz or above noise is expected on the power supply lines.

## 10 Layout

### 10.1 Layout Guidelines

- The  $V^+$  pin should be bypassed to ground with a low-ESR capacitor.
- The optimum placement is closest to the  $V^+$  and ground pins.
- Take care to minimize the loop area formed by the bypass capacitor connection between  $V^+$  and ground.
- The ground pin should be connected to the PCB ground plane at the pin of the device.
- The feedback components should be placed as close to the device as possible minimizing strays.

### 10.2 Layout Example

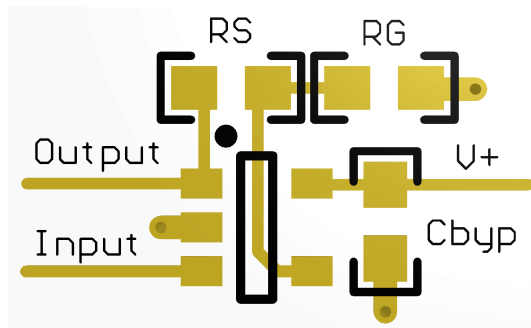

Figure 31. SOT-23 Layout Example

## 11 Device and Documentation Support

### 11.1 Device Support

#### 11.1.1 Development Support

LPV511 PSPICE Model, <http://www.ti.com/lit/zip/snom023>

TINA-TI SPICE-Based Analog Simulation Program, <http://www.ti.com/tool/tina-ti>

DIP Adapter Evaluation Module, <http://www.ti.com/tool/dip-adapter-evm>

TI Universal Operational Amplifier Evaluation Module, <http://www.ti.com/tool/opampevm>

TI Filterpro Software, <http://www.ti.com/tool/filterpro>

### 11.2 Documentation Support

#### 11.2.1 Related Documentation

- [Handbook of Operational Amplifier Applications](#) (SBOA092)
- [Compensate Transimpedance Amplifiers Intuitively](#) (SBOA055)
- [Circuit Board Layout Techniques](#) (SLOA089)
- [AN-1803 Design Considerations for a Transimpedance Amplifier](#) (SNOA515)

### 11.3 Community Resource

The following links connect to TI community resources. Linked contents are provided "AS IS" by the respective contributors. They do not constitute TI specifications and do not necessarily reflect TI's views; see TI's [Terms of Use](#).

**TI E2E™ Online Community** *TI's Engineer-to-Engineer (E2E) Community*. Created to foster collaboration among engineers. At [e2e.ti.com](http://e2e.ti.com), you can ask questions, share knowledge, explore ideas and help solve problems with fellow engineers.

**Design Support** *TI's Design Support* Quickly find helpful E2E forums along with design support tools and contact information for technical support.

### 11.4 Trademarks

E2E is a trademark of Texas Instruments.

All other trademarks are the property of their respective owners.

### 11.5 Electrostatic Discharge Caution



These devices have limited built-in ESD protection. The leads should be shorted together or the device placed in conductive foam during storage or handling to prevent electrostatic damage to the MOS gates.

### 11.6 Glossary

[SLYZ022](#) — *TI Glossary*.

This glossary lists and explains terms, acronyms, and definitions.

## 12 Mechanical, Packaging, and Orderable Information

The following pages include mechanical, packaging, and orderable information. This information is the most current data available for the designated devices. This data is subject to change without notice and revision of this document. For browser-based versions of this data sheet, refer to the left-hand navigation.

**PACKAGING INFORMATION**

Orderable Device	Status (1)	Package Type	Package Drawing	Pins	Package Qty	Eco Plan (2)	Lead finish/ Ball material (6)	MSL Peak Temp (3)	Op Temp (°C)	Device Marking (4/5)	Samples
LPV511MG/NOPB	ACTIVE	SC70	DCK	5	1000	RoHS & Green	SN	Level-1-260C-UNLIM	-40 to 85	A91	<b>Samples</b>
LPV511MGX/NOPB	ACTIVE	SC70	DCK	5	3000	RoHS & Green	SN	Level-1-260C-UNLIM	-40 to 85	A91	<b>Samples</b>

(1) The marketing status values are defined as follows:

**ACTIVE:** Product device recommended for new designs.

**LIFEBUY:** TI has announced that the device will be discontinued, and a lifetime-buy period is in effect.

**NRND:** Not recommended for new designs. Device is in production to support existing customers, but TI does not recommend using this part in a new design.

**PREVIEW:** Device has been announced but is not in production. Samples may or may not be available.

**OBSOLETE:** TI has discontinued the production of the device.

(2) **RoHS:** TI defines "RoHS" to mean semiconductor products that are compliant with the current EU RoHS requirements for all 10 RoHS substances, including the requirement that RoHS substance do not exceed 0.1% by weight in homogeneous materials. Where designed to be soldered at high temperatures, "RoHS" products are suitable for use in specified lead-free processes. TI may reference these types of products as "Pb-Free".

**RoHS Exempt:** TI defines "RoHS Exempt" to mean products that contain lead but are compliant with EU RoHS pursuant to a specific EU RoHS exemption.

**Green:** TI defines "Green" to mean the content of Chlorine (Cl) and Bromine (Br) based flame retardants meet JS709B low halogen requirements of <=1000ppm threshold. Antimony trioxide based flame retardants must also meet the <=1000ppm threshold requirement.

(3) MSL, Peak Temp. - The Moisture Sensitivity Level rating according to the JEDEC industry standard classifications, and peak solder temperature.

(4) There may be additional marking, which relates to the logo, the lot trace code information, or the environmental category on the device.

(5) Multiple Device Markings will be inside parentheses. Only one Device Marking contained in parentheses and separated by a "~" will appear on a device. If a line is indented then it is a continuation of the previous line and the two combined represent the entire Device Marking for that device.

(6) Lead finish/Ball material - Orderable Devices may have multiple material finish options. Finish options are separated by a vertical ruled line. Lead finish/Ball material values may wrap to two lines if the finish value exceeds the maximum column width.

**Important Information and Disclaimer:**The information provided on this page represents TI's knowledge and belief as of the date that it is provided. TI bases its knowledge and belief on information provided by third parties, and makes no representation or warranty as to the accuracy of such information. Efforts are underway to better integrate information from third parties. TI has taken and continues to take reasonable steps to provide representative and accurate information but may not have conducted destructive testing or chemical analysis on incoming materials and chemicals. TI and TI suppliers consider certain information to be proprietary, and thus CAS numbers and other limited information may not be available for release.

In no event shall TI's liability arising out of such information exceed the total purchase price of the TI part(s) at issue in this document sold by TI to Customer on an annual basis.



**TAPE AND REEL INFORMATION**

**QUADRANT ASSIGNMENTS FOR PIN 1 ORIENTATION IN TAPE**

\*All dimensions are nominal

Device	Package Type	Package Drawing	Pins	SPQ	Reel Diameter (mm)	Reel Width W1 (mm)	A0 (mm)	B0 (mm)	K0 (mm)	P1 (mm)	W (mm)	Pin1 Quadrant
LPV511MG/NOPB	SC70	DCK	5	1000	178.0	8.4	2.25	2.45	1.2	4.0	8.0	Q3
LPV511MGX/NOPB	SC70	DCK	5	3000	178.0	8.4	2.25	2.45	1.2	4.0	8.0	Q3

**TAPE AND REEL BOX DIMENSIONS**

\*All dimensions are nominal

Device	Package Type	Package Drawing	Pins	SPQ	Length (mm)	Width (mm)	Height (mm)
LPV511MG/NOPB	SC70	DCK	5	1000	208.0	191.0	35.0
LPV511MGX/NOPB	SC70	DCK	5	3000	208.0	191.0	35.0

DCK (R-PDSO-G5)

PLASTIC SMALL-OUTLINE PACKAGE



- NOTES:
- A. All linear dimensions are in millimeters.
  - B. This drawing is subject to change without notice.
  - C. Body dimensions do not include mold flash or protrusion. Mold flash and protrusion shall not exceed 0.15 per side.
  - D. Falls within JEDEC MO-203 variation AA.



DCK (R-PDSO-G5)

PLASTIC SMALL OUTLINE



- NOTES:
- A. All linear dimensions are in millimeters.
  - B. This drawing is subject to change without notice.
  - C. Customers should place a note on the circuit board fabrication drawing not to alter the center solder mask defined pad.
  - D. Publication IPC-7351 is recommended for alternate designs.
  - E. Laser cutting apertures with trapezoidal walls and also rounding corners will offer better paste release. Customers should contact their board assembly site for stencil design recommendations. Example stencil design based on a 50% volumetric metal load solder paste. Refer to IPC-7525 for other stencil recommendations.

## IMPORTANT NOTICE AND DISCLAIMER

TI PROVIDES TECHNICAL AND RELIABILITY DATA (INCLUDING DATA SHEETS), DESIGN RESOURCES (INCLUDING REFERENCE DESIGNS), APPLICATION OR OTHER DESIGN ADVICE, WEB TOOLS, SAFETY INFORMATION, AND OTHER RESOURCES "AS IS" AND WITH ALL FAULTS, AND DISCLAIMS ALL WARRANTIES, EXPRESS AND IMPLIED, INCLUDING WITHOUT LIMITATION ANY IMPLIED WARRANTIES OF MERCHANTABILITY, FITNESS FOR A PARTICULAR PURPOSE OR NON-INFRINGEMENT OF THIRD PARTY INTELLECTUAL PROPERTY RIGHTS.

These resources are intended for skilled developers designing with TI products. You are solely responsible for (1) selecting the appropriate TI products for your application, (2) designing, validating and testing your application, and (3) ensuring your application meets applicable standards, and any other safety, security, regulatory or other requirements.

These resources are subject to change without notice. TI grants you permission to use these resources only for development of an application that uses the TI products described in the resource. Other reproduction and display of these resources is prohibited. No license is granted to any other TI intellectual property right or to any third party intellectual property right. TI disclaims responsibility for, and you will fully indemnify TI and its representatives against, any claims, damages, costs, losses, and liabilities arising out of your use of these resources.

TI's products are provided subject to [TI's Terms of Sale](#) or other applicable terms available either on [ti.com](http://ti.com) or provided in conjunction with such TI products. TI's provision of these resources does not expand or otherwise alter TI's applicable warranties or warranty disclaimers for TI products.

TI objects to and rejects any additional or different terms you may have proposed.

Mailing Address: Texas Instruments, Post Office Box 655303, Dallas, Texas 75265  
Copyright © 2021, Texas Instruments Incorporated