

## AMC1301 Precision, $\pm 250$ -mV Input, 3- $\mu$ s Delay, Reinforced Isolated Amplifier

### 1 Features

- $\pm 250$ -mV input voltage range optimized for current measurement using shunt resistors
- Low offset error and drift:  
 $\pm 200 \mu\text{V}$  at  $25^\circ\text{C}$ ,  $\pm 3 \mu\text{V}/^\circ\text{C}$
- Fixed gain: 8.2
- Very low gain error and drift:  
 $\pm 0.3\%$  at  $25^\circ\text{C}$ ,  $\pm 50 \text{ ppm}/^\circ\text{C}$
- Very low nonlinearity and drift:  
0.03%, 1 ppm/ $^\circ\text{C}$
- 3.3-V operation on high-side and low-side
- System-level diagnostic features
- Safety-related certifications:
  - 7000- $V_{\text{PK}}$  reinforced isolation per DIN VDE V 0884-11: 2017-01
  - 5000- $V_{\text{RMS}}$  isolation for 1 minute per UL1577
  - CAN/CSA no. 5A-component acceptance service notice and IEC 62368-1 end equipment standard
- Fully specified over the extended industrial temperature range

### 2 Applications

- Shunt-resistor-based current sensing in:
  - [Motor drives](#)
  - [Frequency inverters](#)
  - [Uninterruptible power supplies](#)
- Isolated voltage sensing

### 3 Description

The AMC1301 is a precision, isolated amplifier with an output separated from the input circuitry by an isolation barrier that is highly resistant to magnetic interference. This barrier is certified to provide reinforced galvanic isolation of up to 7 kV<sub>PEAK</sub> according to VDE V 0884-11 and UL1577. Used in conjunction with isolated power supplies, this device prevents noise currents on a high common-mode voltage line from entering the local ground and interfering with or damaging sensitive circuitry.

The input of the AMC1301 is optimized for direct connection to shunt resistors or other low voltage-level signal sources. The excellent performance of the device supports accurate current control resulting in system-level power savings and, especially in motor control applications, lower torque ripple. The integrated common-mode overvoltage and missing high-side supply voltage detection features of the AMC1301 simplify system-level design and diagnostics.

The AMC1301 is fully specified over the extended industrial temperature range of  $-40^\circ\text{C}$  to  $+125^\circ\text{C}$  and is available in a wide-body 8-pin SOIC (DWV) package. The AMC1301S is specified over the temperature range of  $-55^\circ\text{C}$  to  $+125^\circ\text{C}$ .

#### Device Information<sup>(1)</sup>

PART NUMBER	PACKAGE	BODY SIZE (NOM)
AMC1301	SOIC (8)	5.85 mm x 7.50 mm

(1) For all available packages, see the orderable addendum at the end of the data sheet.

#### Simplified Schematic

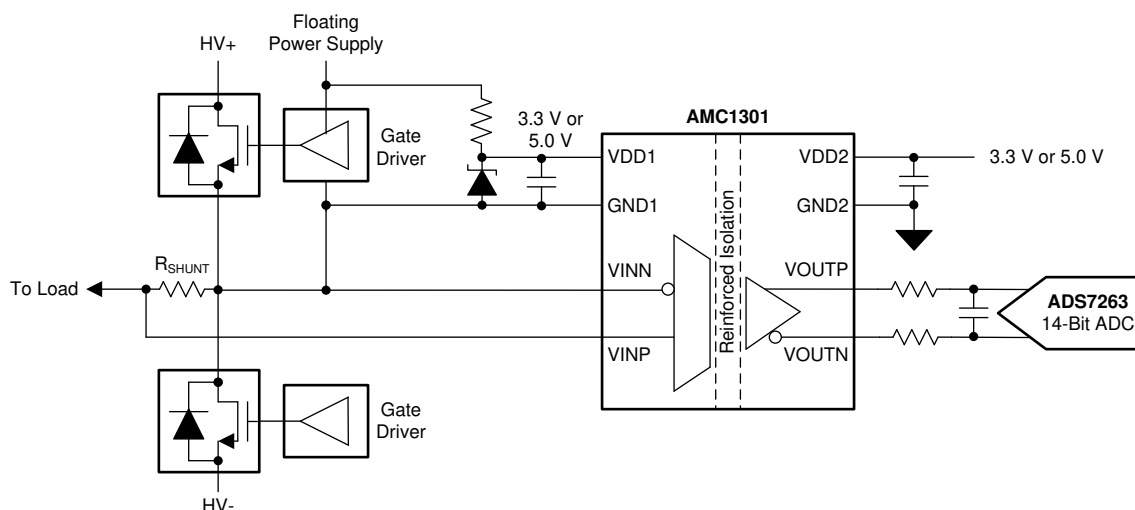

## Table of Contents

<b>1 Features</b> .....	<b>1</b>	9.1 Overview .....	18
<b>2 Applications</b> .....	<b>1</b>	9.2 Functional Block Diagram .....	18
<b>3 Description</b> .....	<b>1</b>	9.3 Feature Description .....	18
<b>4 Revision History</b> .....	<b>2</b>	9.4 Device Functional Modes .....	19
<b>5 Device Comparison Table</b> .....	<b>4</b>	<b>10 Application and Implementation</b> .....	<b>20</b>
<b>6 Pin Configuration and Functions</b> .....	<b>4</b>	10.1 Application Information .....	20
<b>7 Specifications</b> .....	<b>5</b>	10.2 Typical Applications .....	20
7.1 Absolute Maximum Ratings .....	5	10.3 What To Do and What Not TO Do .....	24
7.2 ESD Ratings .....	5	<b>11 Power Supply Recommendations</b> .....	<b>25</b>
7.3 Recommended Operating Conditions .....	5	<b>12 Layout</b> .....	<b>26</b>
7.4 Thermal Information .....	5	12.1 Layout Guidelines .....	26
7.5 Power Ratings .....	5	12.2 Layout Example .....	26
7.6 Insulation Specifications .....	6	<b>13 Device and Documentation Support</b> .....	<b>27</b>
7.7 Safety-Related Certifications .....	7	13.1 Device Support .....	27
7.8 Safety Limiting Values .....	7	13.2 Documentation Support .....	27
7.9 Electrical Characteristics .....	7	13.3 Receiving Notification of Documentation Updates .....	27
7.10 Insulation Characteristics Curves .....	9	13.4 Community Resources .....	27
7.11 Typical Characteristics .....	10	13.5 Trademarks .....	27
<b>8 Parameter Measurement Information</b> .....	<b>17</b>	13.6 Electrostatic Discharge Caution .....	27
8.1 Timing Diagrams .....	17	13.7 Glossary .....	27
<b>9 Detailed Description</b> .....	<b>18</b>	<b>14 Mechanical, Packaging, and Orderable Information</b> .....	<b>27</b>

## 4 Revision History

NOTE: Page numbers for previous revisions may differ from page numbers in the current version.

Changes from Revision E (March 2018) to Revision F	Page
• Changed safety-related certifications details as per ISO standard .....	1
• Changed <i>IEC 60950-1</i> and <i>IEC60065</i> to <i>IEC 62368-1</i> .....	1
• Changed <i>VDE V 0884-10</i> to <i>VDE V 0884-11</i> in <i>Description</i> section .....	1
• Changed $T_A$ parameter from <i>specified</i> to <i>operating</i> in <i>Device Comparison Table</i> .....	4
• Changed CLR and CPG values from 9 mm to 8.5 mm .....	6
• Changed <i>Insulation Specifications</i> table per ISO standard .....	6
• Changed <i>Safety-Related Certification</i> table per ISO standard .....	7
• Changed <i>Safety Limiting Values</i> description as per ISO standard .....	7
• Changed <i>Rise and Fall Time Test Waveforms</i> figure .....	17
• Changed <i>Delay Time Test Waveforms</i> figure .....	17
• Changed <i>Functional Block Diagram</i> figure .....	18

Changes from Revision D (January 2017) to Revision E	Page
• Added AMC1301S device to document .....	1
• Added last sentence to <i>Description</i> section .....	1
• Added <i>Device Comparison Table</i> section .....	4
• Added AMC1301S row to $T_A$ parameter in <i>Recommended Operating Conditions</i> table .....	5
• Added AMC1301S row to <i>Climatic category</i> parameter of <i>Insulation Specifications</i> table .....	6
• Added AMC1301S temperature range to conditions statement of <i>Electrical Characteristics</i> table .....	7
• Added AMC1301S row to $TCV_{OS}$ parameter in <i>Electrical Characteristics</i> table .....	7
• Changed $I_{IB}$ parameter specification and conditions .....	7

• Added AMC1301S row to TCE <sub>G</sub> parameter in <i>Electrical Characteristics</i> table .....	8
• Changed all temperature plots in Typical Characteristics section to cover –55°C for the AMC1301S and added respective footnote .....	10
• Changed <i>Input Bias Current vs Common-Mode Input Voltage</i> figure to align with new test condition .....	11
• Changed <i>Input Bias Current vs High-Side Supply Voltage</i> figure to align with new test condition .....	11
• Changed <i>Input Bias Current vs Temperature</i> figure to align with new test condition .....	12
• Changed legend of <i>Output Voltage vs Input Voltage</i> figure, V <sub>OUTP</sub> is now red and V <sub>OUTN</sub> is now black .....	13

---

<b>Changes from Revision C (September 2016) to Revision D</b>	<b>Page</b>
---	-------------

• Changed VDD1 to VDD2 in test conditions of I <sub>DD2</sub> and P <sub>DD2</sub> parameters of <i>Electrical Characteristics</i> table .....	8
• Changed VDD2 to VDD1 in conditions of <i>Gain Error Histogram</i> figures .....	12

---

<b>Changes from Revision B (June 2016) to Revision C</b>	<b>Page</b>
--	-------------

• Changed 12-Bit ADC to 14-Bit ADC in <i>Simplified Schematic</i> figure .....	1
• Changed maximum specification of <i>Supply voltage</i> row in <i>Absolute Maximum Ratings</i> table .....	5
• Changed 12-Bit ADC to 14-Bit ADC in <i>Zener-Diode Based, High Side Power Supply</i> figure in <i>Power Supply Recommendations</i> section .....	25

---

<b>Changes from Revision A (April 2016) to Revision B</b>	<b>Page</b>
---	-------------

• Changed Features bullet from "Safety and Regulatory Approvals" to "Safety-Related Certifications" .....	1
• Changed <i>Simplified Schematic</i> figure in <i>Device Information</i> table .....	1
• Changed section title from "Regulatory Information" to "Safety-Related Certifications" .....	7
• Changed V <sub>CM</sub> test conditions in <i>Electrical Characteristics</i> table .....	7
• Added V <sub>IN</sub> footnote to <i>Electrical Characteristics</i> table .....	7
• Changed V <sub>IN</sub> test conditions in <i>Electrical Characteristics</i> table .....	7
• Changed V <sub>IN</sub> units in <i>Electrical Characteristics</i> table .....	7
• Changed common-mode rejection ratio test condition in <i>Electrical Characteristics</i> table .....	7
• Changed R <sub>IN</sub> parameter information in <i>Electrical Characteristics</i> table .....	7
• Changed output noise equation in <i>Electrical Characteristics</i> table .....	8
• Deleted "Safety and" from <i>Insulation Characteristics Curves</i> section title .....	9
• Changed <i>Using the AMC1301 for Current Sensing in Frequency Inverters</i> figure in <i>Application Information</i> .....	20
• Changed <i>Zener-Diode Based, High Side Power Supply</i> figure in <i>Power Supply Recommendations</i> .....	25
• Added a paragraph and changed the formatting of the <i>Related Documentation</i> section .....	27

---

<b>Changes from Original (April 2016) to Revision A</b>	<b>Page</b>
---	-------------

• Released to production .....	1
--------------------------------	---

## 5 Device Comparison Table

PARAMETER	AMC1301S	AMC1301
Operating ambient temperature, $T_A$	-55°C to +125°C	-40°C to +125°C
Input offset drift, $TCV_{OS}$	$\pm 4 \mu V/^\circ C$ (max)	$\pm 3 \mu V/^\circ C$ (max)
Gain error drift, $TCE_G$	$\pm 60 \text{ ppm}/^\circ C$ (max)	$\pm 50 \text{ ppm}/^\circ C$ (max)

## 6 Pin Configuration and Functions

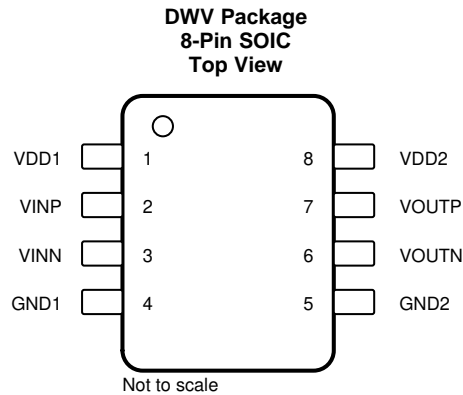

### Pin Functions

PIN		I/O	DESCRIPTION
NAME	NO.		
GND1	4	—	High-side analog ground
GND2	5	—	Low-side analog ground
VDD1	1	—	High-side power supply, 3.0 V to 5.5 V. See the <a href="#">Power Supply Recommendations</a> section for decoupling recommendations.
VDD2	8	—	Low-side power supply, 3.0 V to 5.5 V. See the <a href="#">Power Supply Recommendations</a> section for decoupling recommendations.
VINN	3	I	Inverting analog input
VINP	2	I	Noninverting analog input
VOUTN	6	O	Inverting analog output
VOUTP	7	O	Noninverting analog output

## 7 Specifications

### 7.1 Absolute Maximum Ratings<sup>(1)</sup>

	MIN	MAX	UNIT
Supply voltage, VDD1 to GND1 or VDD2 to GND2	–0.3	7	V
Analog input voltage at VINP, VINN	GND1 – 6	VDD1 + 0.5	V
Input current to any pin except supply pins	–10	10	mA
Junction temperature, T <sub>J</sub>		150	°C
Storage temperature, T <sub>stg</sub>	–65	150	°C

- (1) Stresses beyond those listed under *Absolute Maximum Ratings* may cause permanent damage to the device. These are stress ratings only, which do not imply functional operation of the device at these or any other conditions beyond those indicated under *Recommended Operating Conditions*. Exposure to absolute-maximum-rated conditions for extended periods may affect device reliability.

### 7.2 ESD Ratings

			VALUE	UNIT
V <sub>(ESD)</sub>	Electrostatic discharge	Human-body model (HBM), per ANSI/ESDA/JEDEC JS-001 <sup>(1)</sup>	±2000	V
		Charged-device model (CDM), per JEDEC specification JESD22-C101 <sup>(2)</sup>	±1000	

- (1) JEDEC document JEP155 states that 500-V HBM allows safe manufacturing with a standard ESD control process.

- (2) JEDEC document JEP157 states that 250-V CDM allows safe manufacturing with a standard ESD control process.

### 7.3 Recommended Operating Conditions

over operating ambient temperature range (unless otherwise noted)

			MIN	NOM	MAX	UNIT
VDD1	High-side supply voltage (VDD1 to GND1)		3.0	5.0	5.5	V
VDD2	Low-side supply voltage (VDD2 to GND2)		3.0	3.3	5.5	V
T <sub>A</sub>	Operating ambient temperature	AMC1301	–40		125	°C
		AMC1301S	–55		125	°C

### 7.4 Thermal Information

THERMAL METRIC <sup>(1)</sup>		AMC1301	UNIT
		DWV (SOIC)	
		8 PINS	
R <sub>θJA</sub>	Junction-to-ambient thermal resistance	110.1	°C/W
R <sub>θJC(top)</sub>	Junction-to-case (top) thermal resistance	51.7	°C/W
R <sub>θJB</sub>	Junction-to-board thermal resistance	66.4	°C/W
ψ <sub>JT</sub>	Junction-to-top characterization parameter	16.0	°C/W
ψ <sub>JB</sub>	Junction-to-board characterization parameter	64.5	°C/W
R <sub>θJC(bot)</sub>	Junction-to-case (bottom) thermal resistance	N/A	°C/W

- (1) For more information about traditional and new thermal metrics, see the [Semiconductor and IC Package Thermal Metrics](#) application report.

### 7.5 Power Ratings

PARAMETER		TEST CONDITIONS	VALUE	UNIT
P <sub>D</sub>	Maximum power dissipation (both sides)	VDD1 = VDD2 = 5.5 V	81.4	mW
P <sub>D1</sub>	Maximum power dissipation (high-side supply)		45.65	mW
P <sub>D2</sub>	Maximum power dissipation (low-side supply)		35.75	mW

## 7.6 Insulation Specifications

over operating ambient temperature range (unless otherwise noted)

PARAMETER		TEST CONDITIONS	VALUE	UNIT
<b>GENERAL</b>				
CLR	External clearance <sup>(1)</sup>	Shortest pin-to-pin distance through air	≥ 8.5	mm
CPG	External creepage <sup>(1)</sup>	Shortest pin-to-pin distance across the package surface	≥ 8.5	mm
DTI	Distance through insulation	Minimum internal gap (internal clearance) of the double insulation (2 × 0.0135 mm)	≥ 0.027	mm
CTI	Comparative tracking index	DIN EN 60112 (VDE 0303-11); IEC 60112	≥ 600	V
	Material group	According to IEC 60664-1	I	
	Overvoltage category per IEC 60664-1	Rated mains voltage ≤ 300 V <sub>RMS</sub>	I-IV	
		Rated mains voltage ≤ 600 V <sub>RMS</sub>	I-III	
		Rated mains voltage ≤ 1000 V <sub>RMS</sub>	I-II	
<b>DIN VDE V 0884-11: 2017-01<sup>(2)</sup></b>				
V <sub>IORM</sub>	Maximum repetitive peak isolation voltage	At ac voltage (bipolar)	1500	V <sub>PK</sub>
V <sub>IOWM</sub>	Maximum-rated isolation working voltage	At ac voltage (sine wave)	1000	V <sub>RMS</sub>
		At dc voltage	1500	V <sub>DC</sub>
V <sub>IOTM</sub>	Maximum transient isolation voltage	V <sub>TEST</sub> = V <sub>IOTM</sub> , t = 60 s (qualification test)	7000	V <sub>PK</sub>
		V <sub>TEST</sub> = 1.2 × V <sub>IOTM</sub> , t = 1 s (100% production test)	8400	
V <sub>IOSM</sub>	Maximum surge isolation voltage <sup>(3)</sup>	Test method per IEC 60065, 1.2/50-μs waveform, V <sub>TEST</sub> = 1.6 × V <sub>IOSM</sub> = 10000 V <sub>PK</sub> (qualification)	6250	V <sub>PK</sub>
q <sub>pd</sub>	Apparent charge <sup>(4)</sup>	Method a, after input/output safety test subgroup 2 / 3, V <sub>ini</sub> = V <sub>IOTM</sub> , t <sub>ini</sub> = 60 s, V <sub>pd(m)</sub> = 1.2 × V <sub>IORM</sub> = 1800 V <sub>PK</sub> , t <sub>m</sub> = 10 s	≤ 5	pC
		Method a, after environmental tests subgroup 1, V <sub>ini</sub> = V <sub>IOTM</sub> , t <sub>ini</sub> = 60 s, V <sub>pd(m)</sub> = 1.6 × V <sub>IORM</sub> = 2400 V <sub>PK</sub> , t <sub>m</sub> = 10 s	≤ 5	
		Method b1, at routine test (100% production) and preconditioning (type test), V <sub>ini</sub> = V <sub>IOTM</sub> , t <sub>ini</sub> = 1 s, V <sub>pd(m)</sub> = 1.875 × V <sub>IORM</sub> = 2812.5 V <sub>PK</sub> , t <sub>m</sub> = 1 s	≤ 5	
C <sub>IO</sub>	Barrier capacitance, input to output <sup>(5)</sup>	V <sub>IO</sub> = 0.5 V <sub>PP</sub> at 1 MHz	1.2	pF
R <sub>IO</sub>	Insulation resistance, input to output <sup>(5)</sup>	V <sub>IO</sub> = 500 V at T <sub>S</sub> = 150°C	> 10 <sup>9</sup>	Ω
	Pollution degree		2	
	Climatic category	AMC1301	40/125/21	
		AMC1301S	55/125/21	
<b>UL1577</b>				
V <sub>ISO</sub>	Withstand isolation voltage	V <sub>TEST</sub> = V <sub>ISO</sub> = 5000 V <sub>RMS</sub> or 7000 V <sub>DC</sub> , t = 60 s (qualification), V <sub>TEST</sub> = 1.2 × V <sub>ISO</sub> = 6000 V <sub>RMS</sub> , t = 1 s (100% production test)	5000	V <sub>RMS</sub>

- (1) Apply creepage and clearance requirements according to the specific equipment isolation standards of an application. Care must be taken to maintain the creepage and clearance distance of a board design to ensure that the mounting pads of the isolator on the printed circuit board (PCB) do not reduce this distance. Creepage and clearance on a PCB become equal in certain cases. Techniques such as inserting grooves and ribs on the PCB are used to help increase these specifications.
- (2) This coupler is suitable for *safe electrical insulation* only within the safety ratings. Compliance with the safety ratings shall be ensured by means of suitable protective circuits.
- (3) Testing is carried out in air or oil to determine the intrinsic surge immunity of the isolation barrier.
- (4) Apparent charge is electrical discharge caused by a partial discharge (pd).
- (5) All pins on each side of the barrier are tied together, creating a two-pin device.

## 7.7 Safety-Related Certifications

VDE	UL
Certified according to DIN VDE V 0884-11: 2017-01, DIN EN 62368-1: 2016-05, EN 62368-1: 2014, and IEC 62368-1: 2014	Recognized under 1577 component recognition and CSA component acceptance NO 5 programs
Reinforced insulation	Single protection
Certificate number: 40040142	File number: E181974

## 7.8 Safety Limiting Values

Safety limiting intends to prevent potential damage to the isolation barrier upon failure of input or output circuitry.

PARAMETER	TEST CONDITIONS	MIN	TYP	MAX	UNIT	
I <sub>S</sub>	Safety input, output, or supply current	R <sub>θJA</sub> = 110.1°C/W, V <sub>I</sub> = 5.5 V, T <sub>J</sub> = 150°C, T <sub>A</sub> = 25°C			206	mA
		R <sub>θJA</sub> = 110.1°C/W, V <sub>I</sub> = 3.6 V, T <sub>J</sub> = 150°C, T <sub>A</sub> = 25°C			315	
P <sub>S</sub>	Safety input, output, or total power <sup>(1)</sup>	R <sub>θJA</sub> = 110.1°C/W, T <sub>J</sub> = 150°C, T <sub>A</sub> = 25°C			1135	mW
T <sub>S</sub>	Maximum safety temperature				150	°C

- (1) The maximum safety temperature, T<sub>S</sub>, has the same value as the maximum junction temperature, T<sub>J</sub>, specified for the device. The I<sub>S</sub> and P<sub>S</sub> parameters represent the safety current and safety power, respectively. Do not exceed the maximum limits of I<sub>S</sub> and P<sub>S</sub>. These limits vary with the ambient temperature, T<sub>A</sub>.

The junction-to-air thermal resistance, R<sub>θJA</sub>, in the Thermal Information table is that of a device installed on a high-K test board for leaded surface-mount packages. Use these equations to calculate the value for each parameter:

$T_J = T_A + R_{\theta JA} \times P$ , where P is the power dissipated in the device.

$T_{J(max)} = T_S = T_A + R_{\theta JA} \times P_S$ , where T<sub>J(max)</sub> is the maximum junction temperature.

$P_S = I_S \times VDD1_{max} + I_S \times VDD2_{max}$ , where VDD1<sub>max</sub> is the maximum high-side voltage and VDD2<sub>max</sub> is the maximum low-side supply voltage.

## 7.9 Electrical Characteristics

minimum and maximum specifications apply from T<sub>A</sub> = –40°C to +125°C (for AMC1301S: T<sub>A</sub> = –55°C to +125°C), VDD1 = 3.0 V to 5.5 V, VDD2 = 3.0 V to 5.5 V, VINP = –250 mV to +250 mV, and VINN = 0 V (unless otherwise noted); typical specifications are at T<sub>A</sub> = 25°C, VDD1 = 5 V, and VDD2 = 3.3 V

PARAMETER	TEST CONDITIONS	MIN	TYP	MAX	UNIT			
<b>ANALOG INPUT</b>								
V <sub>Clipping</sub>	Differential input voltage before clipping output	VINP – VINN			±302.7	mV		
V <sub>FSR</sub>	Specified linear differential full-scale	VINP – VINN			–250	250	mV	
V <sub>CM</sub>	Specified common-mode input voltage	(VINP + VINN) / 2 to GND1			–0.16	VDD1 – 2.1	V	
	Absolute common-mode input voltage <sup>(1)</sup>	(VINN + VINP) / 2 to GND1			–2	VDD1	V	
V <sub>CMov</sub>	Common-mode overvoltage detection level				VDD1 – 2		V	
V <sub>OS</sub>	Input offset voltage	Initial, at T <sub>A</sub> = 25°C, VINP = VINN = GND1			–200	±50	200	μV
TCV <sub>OS</sub>	Input offset drift	AMC1301			–3	±1	3	μV/°C
		AMC1301S			–4	±1	4	
CMRR	Common-mode rejection ratio	f <sub>IN</sub> = 0 Hz, V <sub>CM min</sub> ≤ V <sub>CM</sub> ≤ V <sub>CM max</sub>			–93		dB	
		f <sub>IN</sub> = 10 kHz, V <sub>CM min</sub> ≤ V <sub>CM</sub> ≤ V <sub>CM max</sub>			–93			
C <sub>IND</sub>	Differential input capacitance				1		pF	
R <sub>IN</sub>	Single-ended input resistance	VINN = GND1			18		kΩ	
R <sub>IND</sub>	Differential input resistance				22		kΩ	
I <sub>IB</sub>	Input bias current	VINP = VINN = GND1, I <sub>IB</sub> = (I <sub>IBP</sub> + I <sub>IBN</sub> ) / 2			–41	–30	–24	μA
TCI <sub>IB</sub>	Input bias current drift				1		nA/°C	
BW <sub>IN</sub>	Input bandwidth				1000		kHz	
<b>ANALOG OUTPUT</b>								
	Nominal gain				8.2			

- (1) Steady-state voltage supported by the device in case of a system failure. See specified common-mode input voltage V<sub>CM</sub> for normal operation. Observe analog input voltage range as specified in [Absolute Maximum Ratings](#).

## Electrical Characteristics (continued)

minimum and maximum specifications apply from  $T_A = -40^\circ\text{C}$  to  $+125^\circ\text{C}$  (for AMC1301S:  $T_A = -55^\circ\text{C}$  to  $+125^\circ\text{C}$ ),  $V_{DD1} = 3.0\text{ V}$  to  $5.5\text{ V}$ ,  $V_{DD2} = 3.0\text{ V}$  to  $5.5\text{ V}$ ,  $V_{INP} = -250\text{ mV}$  to  $+250\text{ mV}$ , and  $V_{INN} = 0\text{ V}$  (unless otherwise noted); typical specifications are at  $T_A = 25^\circ\text{C}$ ,  $V_{DD1} = 5\text{ V}$ , and  $V_{DD2} = 3.3\text{ V}$

PARAMETER		TEST CONDITIONS	MIN	TYP	MAX	UNIT
$E_G$	Gain error	Initial, at $T_A = 25^\circ\text{C}$	-0.3%	$\pm 0.05\%$	0.3%	
$TCE_G$	Gain error drift	AMC1301	-50	$\pm 15$	50	ppm/ $^\circ\text{C}$
		AMC1301S	-60	$\pm 15$	60	
	Nonlinearity		-0.03%	$\pm 0.01\%$	0.03%	
	Nonlinearity drift			1		ppm/ $^\circ\text{C}$
THD	Total harmonic distortion	$f_{IN} = 10\text{ kHz}$		-87		dB
	Output noise	$V_{INP} = V_{INN} = \text{GND1}$ , $f_{IN} = 0\text{ Hz}$ , $\text{BW} = 100\text{ kHz}$		220		$\mu\text{V}_{\text{RMS}}$
SNR	Signal-to-noise ratio	$f_{IN} = 1\text{ kHz}$ , $\text{BW} = 10\text{ kHz}$	80	84		dB
		$f_{IN} = 10\text{ kHz}$ , $\text{BW} = 100\text{ kHz}$		71		
PSRR	Power-supply rejection ratio	vs $V_{DD1}$ , at dc		-94		dB
		vs $V_{DD1}$ , 100-mV and 10-kHz ripple		-90		
		vs $V_{DD2}$ , at dc		-100		
		vs $V_{DD2}$ , 100-mV and 10-kHz ripple		-94		
$t_r$	Rise time	See <a href="#">Figure 45</a>		2.0		$\mu\text{s}$
$t_f$	Fall time	See <a href="#">Figure 45</a>		2.0		$\mu\text{s}$
	$V_{IN}$ to $V_{OUT}$ signal delay (50% – 10%)	See <a href="#">Figure 46</a> , unfiltered output		0.7	2.0	$\mu\text{s}$
	$V_{IN}$ to $V_{OUT}$ signal delay (50% – 50%)	See <a href="#">Figure 46</a> , unfiltered output		1.6	2.6	$\mu\text{s}$
	$V_{IN}$ to $V_{OUT}$ signal delay (50% – 90%)	See <a href="#">Figure 46</a> , unfiltered output		2.5	3.0	$\mu\text{s}$
CMTI	Common-mode transient immunity	$ \text{GND1} - \text{GND2}  = 1\text{ kV}$	15			kV/ $\mu\text{s}$
$V_{\text{CMout}}$	Common-mode output voltage		1.39	1.44	1.49	V
	Output short-circuit current			$\pm 13$		mA
$R_{\text{OUT}}$	Output resistance	on $V_{\text{OUTP}}$ or $V_{\text{OUTN}}$		< 0.2		$\Omega$
BW	Output bandwidth		190	210		kHz
$V_{\text{FAILSAFE}}$	Failsafe differential output voltage	$V_{\text{CM}} \geq V_{\text{CMov}}$ , or $V_{\text{DD1}}$ missing	-2.563		-2.545	V
<b>POWER SUPPLY</b>						
$I_{\text{DD1}}$	High-side supply current	$3.0\text{ V} \leq V_{\text{DD1}} \leq 3.6\text{ V}$		5.0	6.9	mA
		$4.5\text{ V} \leq V_{\text{DD1}} \leq 5.5\text{ V}$		5.9	8.3	
$I_{\text{DD2}}$	Low-side supply current	$3.0\text{ V} \leq V_{\text{DD2}} \leq 3.6\text{ V}$		4.4	5.6	mA
		$4.5\text{ V} \leq V_{\text{DD2}} \leq 5.5\text{ V}$		4.8	6.5	
$P_{\text{DD1}}$	High-side power dissipation	$3.0\text{ V} \leq V_{\text{DD1}} \leq 3.6\text{ V}$		16.5	24.84	mW
		$4.5\text{ V} \leq V_{\text{DD1}} \leq 5.5\text{ V}$		29.5	45.65	
$P_{\text{DD2}}$	Low-side power dissipation	$3.0\text{ V} \leq V_{\text{DD2}} \leq 3.6\text{ V}$		14.52	20.16	mW
		$4.5\text{ V} \leq V_{\text{DD2}} \leq 5.5\text{ V}$		24	35.75	



### 7.10 Insulation Characteristics Curves

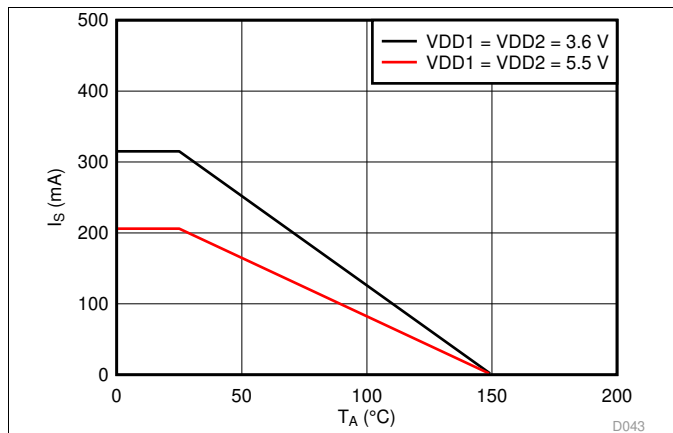

Figure 1. Thermal Derating Curve for Safety-Limiting Current per VDE

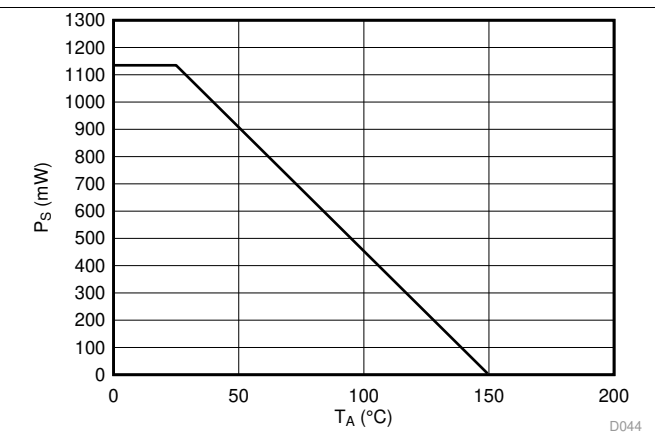
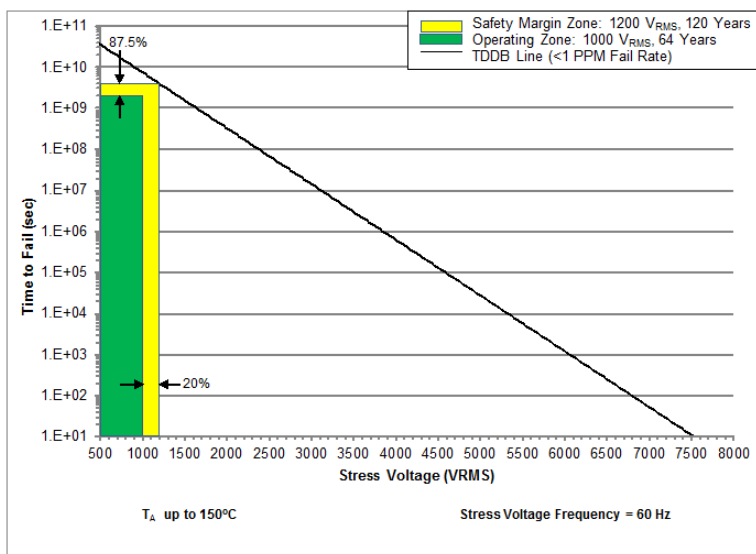

Figure 2. Thermal Derating Curve for Safety-Limiting Power per VDE



TA up to 150°C, stress voltage frequency = 60 Hz

Figure 3. Reinforced Isolation Capacitor Lifetime Projection

### 7.11 Typical Characteristics

at VDD1 = 5 V, VDD2 = 3.3 V, VINP = -250 mV to 250 mV, VINN = 0 V, and f<sub>IN</sub> = 10 kHz (unless otherwise noted)

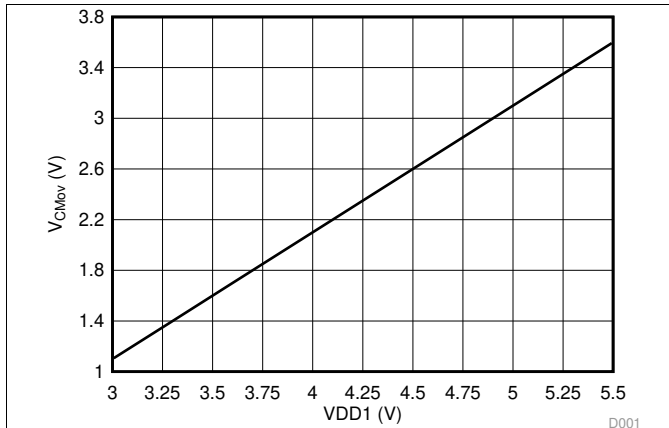

Figure 4. Common-Mode Overvoltage Detection Level vs High-Side Supply Voltage

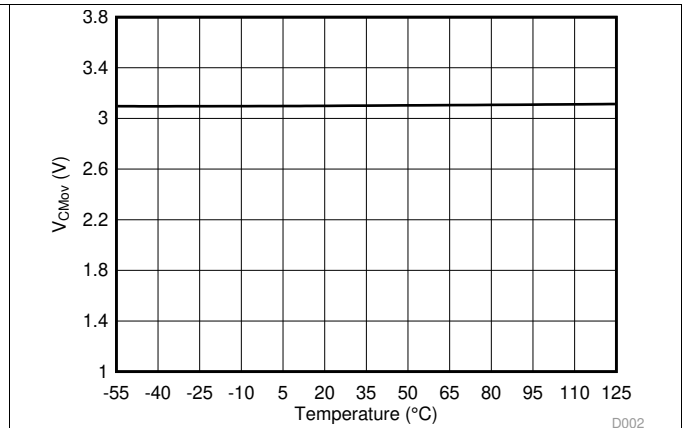

Figure 5. Common-Mode Overvoltage Detection Level vs Temperature  
-55°C ≤ T<sub>A</sub> < 40°C valid for the AMC1301S only

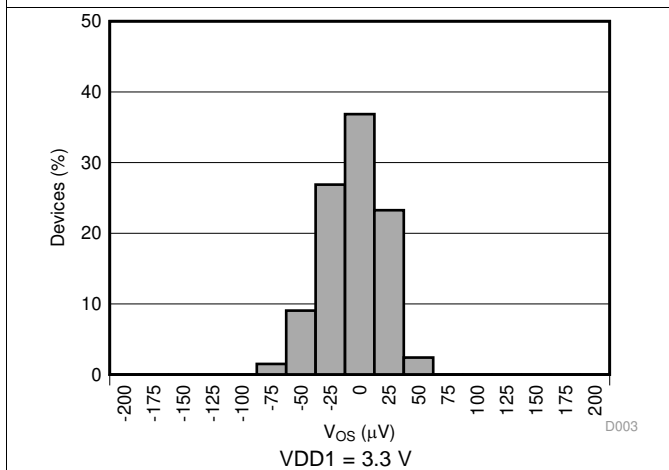

Figure 6. Input Offset Voltage Histogram

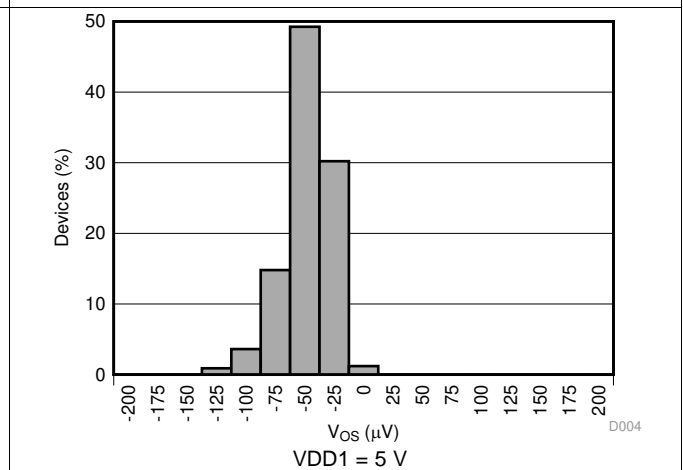

Figure 7. Input Offset Voltage Histogram

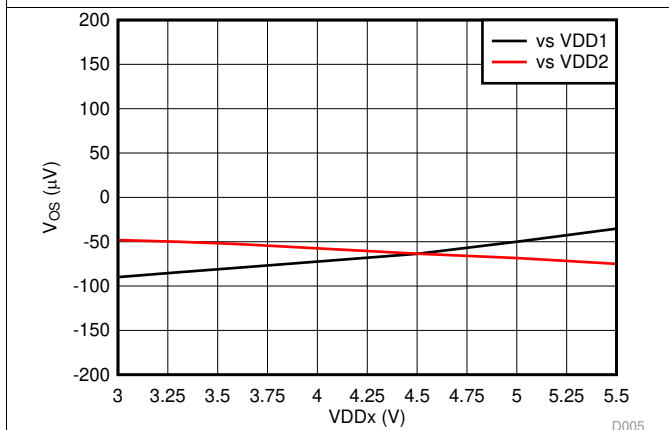
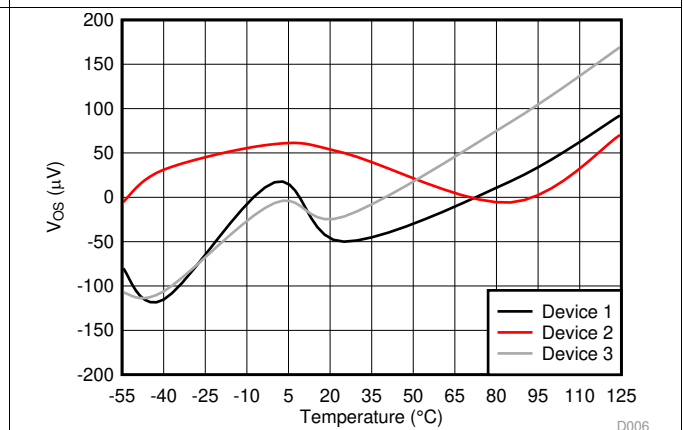

Figure 8. Input Offset Voltage vs Supply Voltage



-55°C ≤ T<sub>A</sub> < 40°C valid for the AMC1301S only

Figure 9. Input Offset Voltage vs Temperature

Typical Characteristics (continued)

at VDD1 = 5 V, VDD2 = 3.3 V, VINP = -250 mV to 250 mV, VINN = 0 V, and f<sub>IN</sub> = 10 kHz (unless otherwise noted)

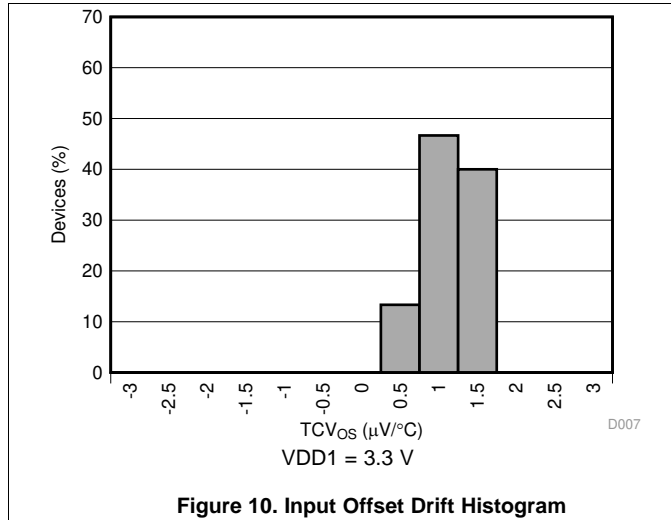

Figure 10. Input Offset Drift Histogram

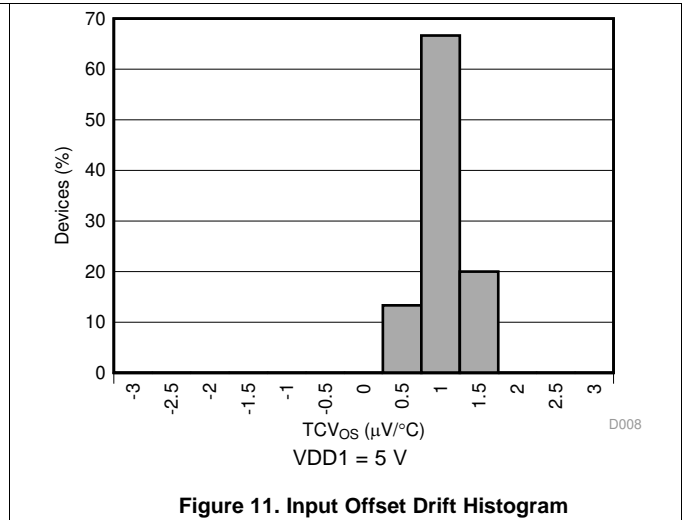

Figure 11. Input Offset Drift Histogram

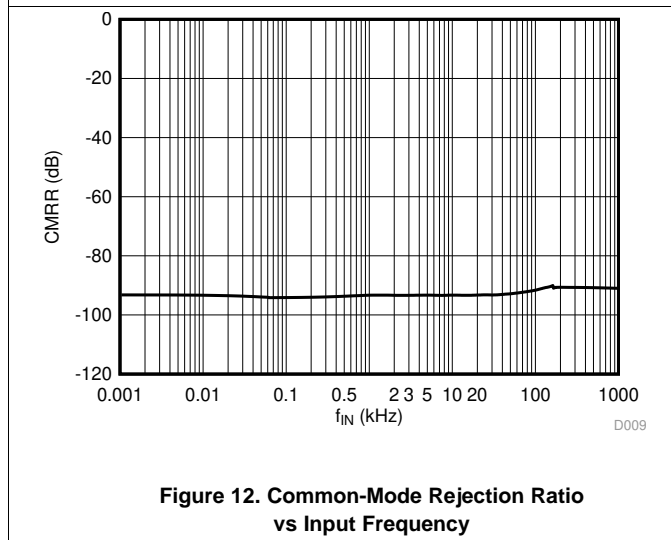

Figure 12. Common-Mode Rejection Ratio vs Input Frequency

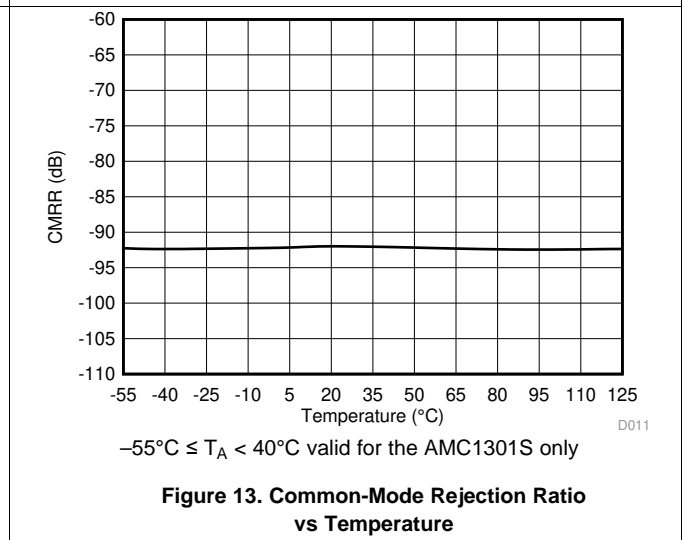

Figure 13. Common-Mode Rejection Ratio vs Temperature

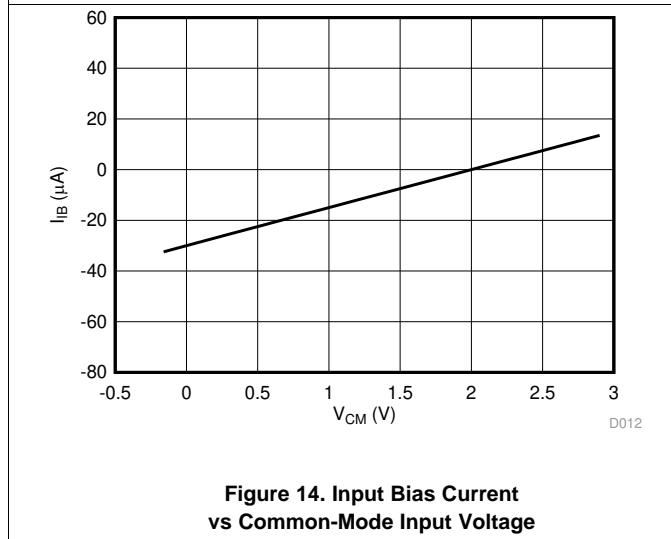

Figure 14. Input Bias Current vs Common-Mode Input Voltage

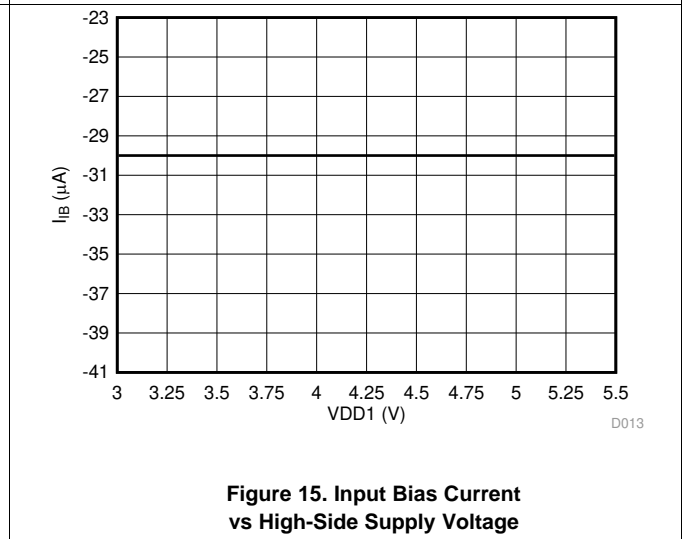

Figure 15. Input Bias Current vs High-Side Supply Voltage

### Typical Characteristics (continued)

at VDD1 = 5 V, VDD2 = 3.3 V, VINP = -250 mV to 250 mV, VINN = 0 V, and  $f_{IN} = 10$  kHz (unless otherwise noted)

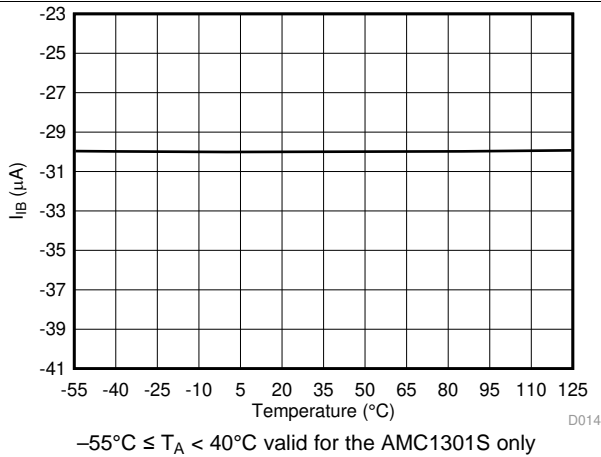

Figure 16. Input Bias Current vs Temperature

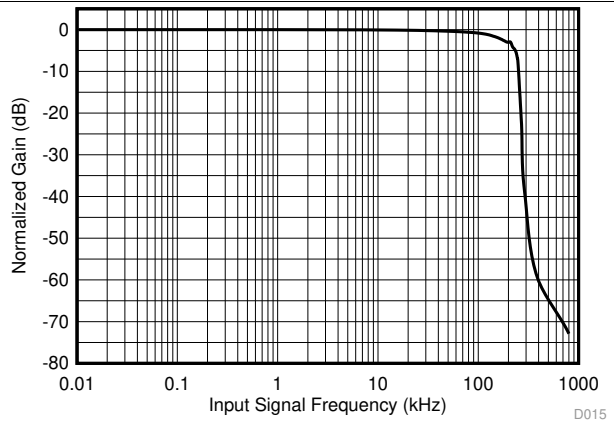

Figure 17. Normalized Gain vs Input Frequency

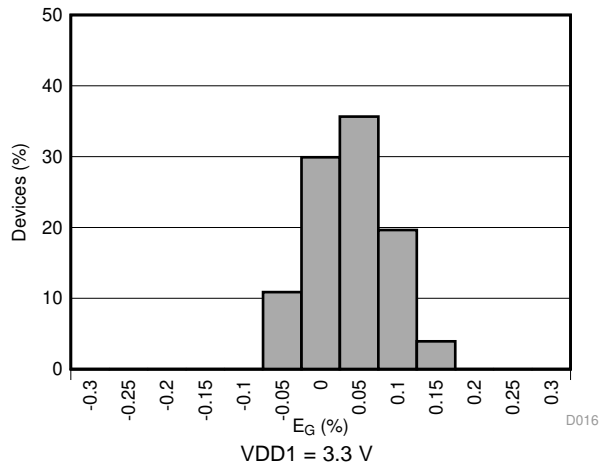

Figure 18. Gain Error Histogram

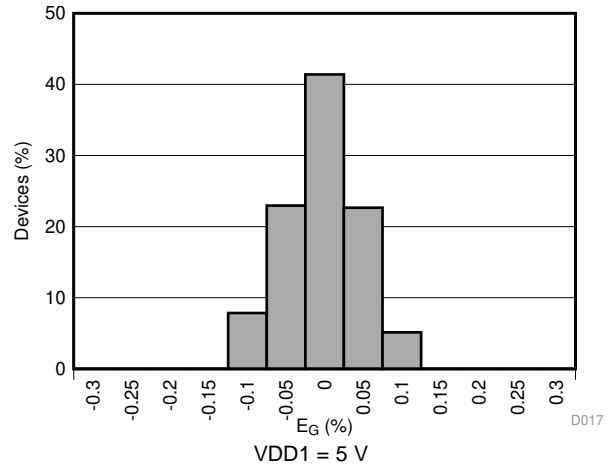

Figure 19. Gain Error Histogram

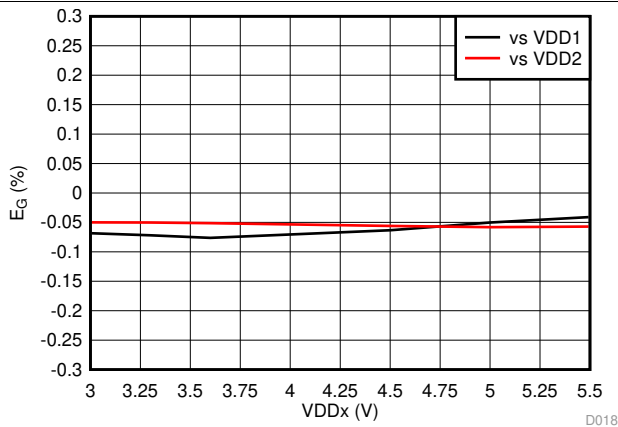

Figure 20. Gain Error vs Supply Voltage

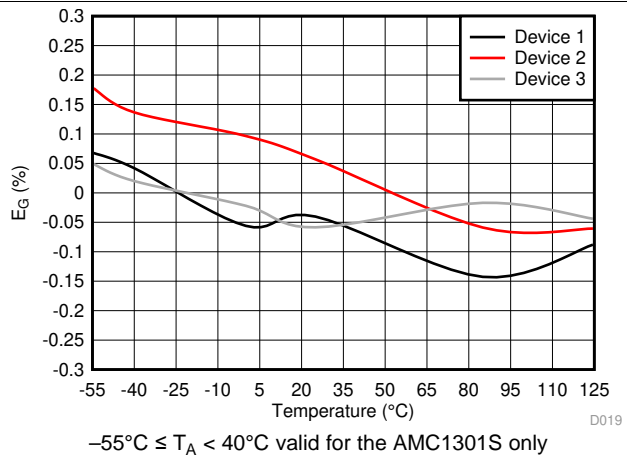

Figure 21. Gain Error vs Temperature

Typical Characteristics (continued)

at VDD1 = 5 V, VDD2 = 3.3 V, VINP = -250 mV to 250 mV, VINN = 0 V, and f<sub>IN</sub> = 10 kHz (unless otherwise noted)

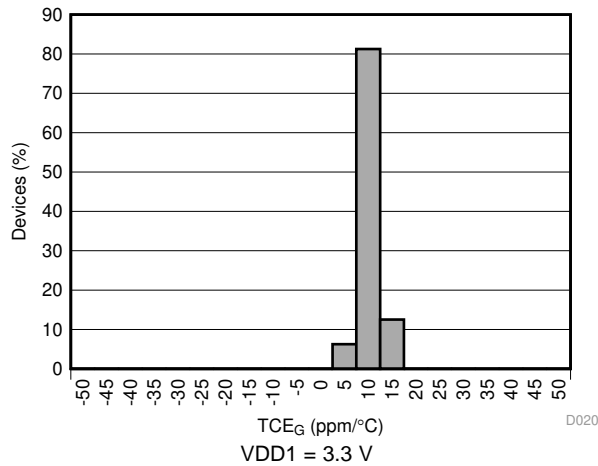

Figure 22. Gain Error Drift Histogram

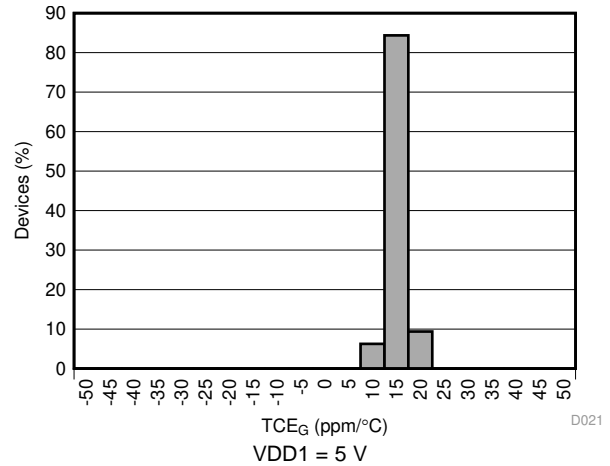

Figure 23. Gain Error Drift Histogram

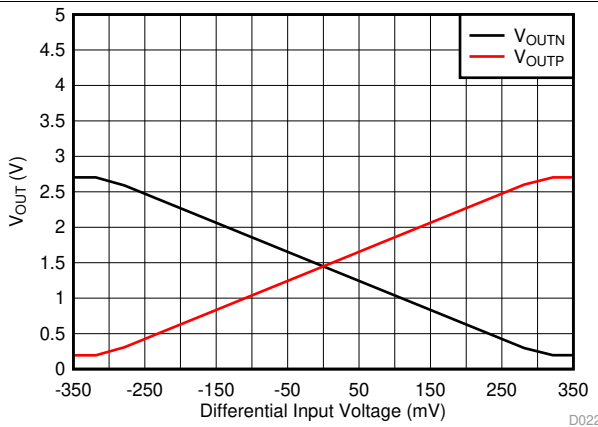

Figure 24. Output Voltage vs Input Voltage

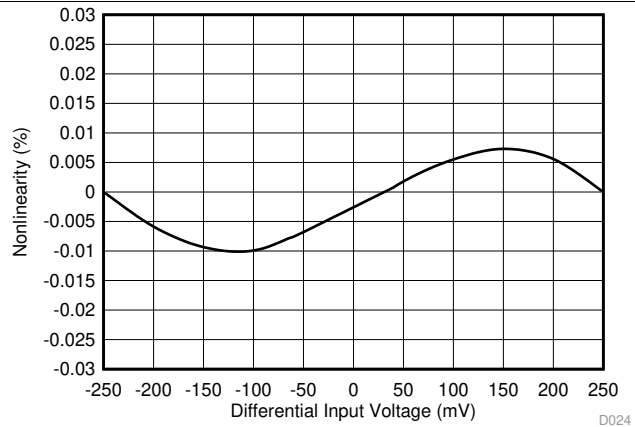

Figure 25. Nonlinearity vs Input Voltage

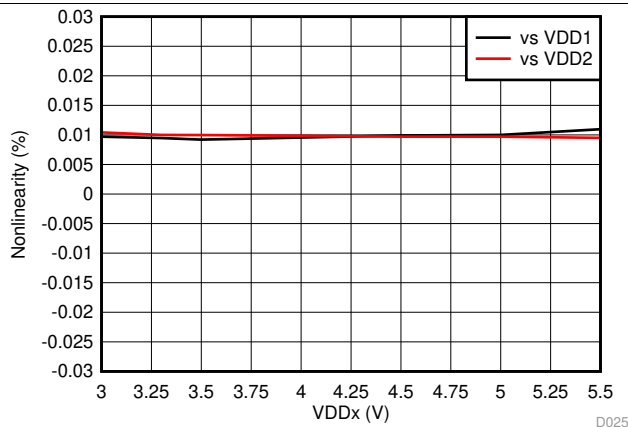

Figure 26. Nonlinearity vs Supply Voltage

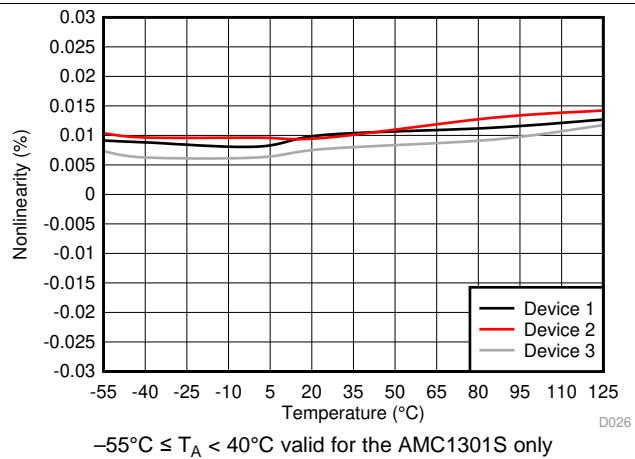

Figure 27. Nonlinearity vs Temperature

### Typical Characteristics (continued)

at VDD1 = 5 V, VDD2 = 3.3 V, VINP = -250 mV to 250 mV, VINN = 0 V, and  $f_{IN} = 10$  kHz (unless otherwise noted)

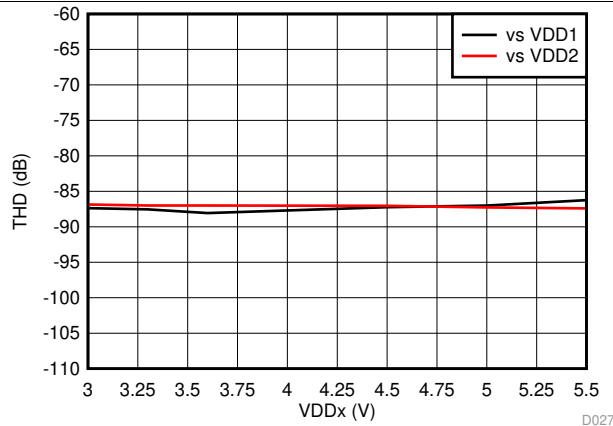

Figure 28. Total Harmonic Distortion vs Supply Voltage

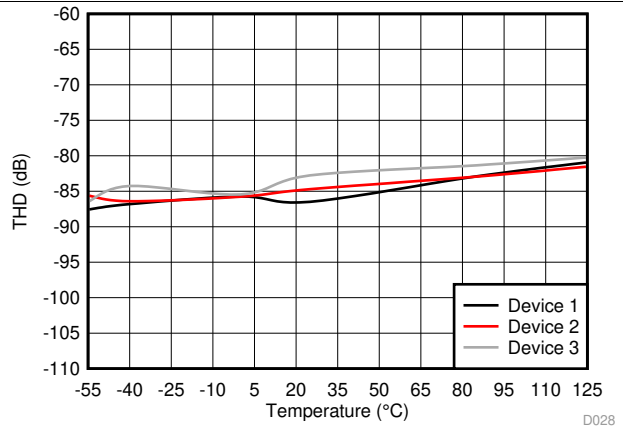

Figure 29. Total Harmonic Distortion vs Temperature

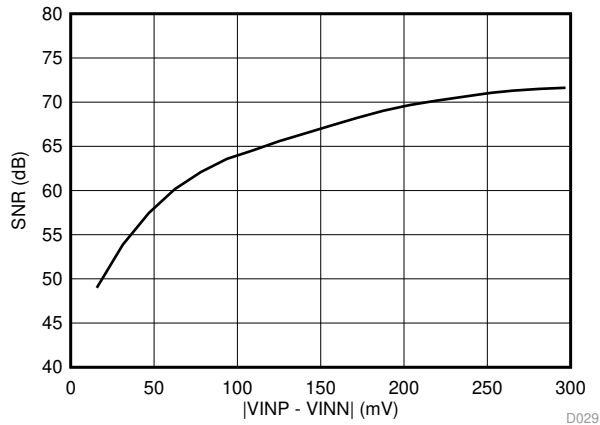

Figure 30. Signal-to-Noise Ratio vs Input Voltage

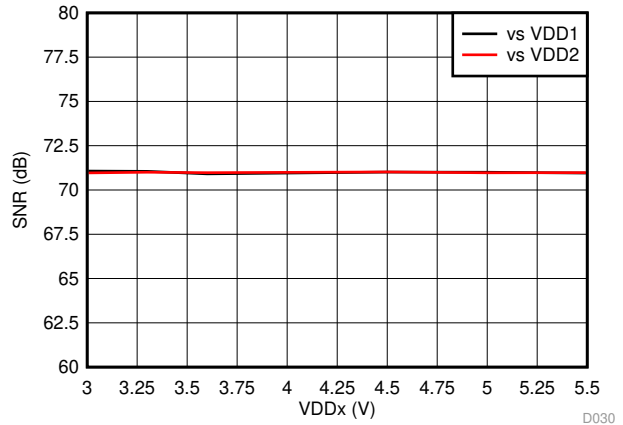

Figure 31. Signal-to-Noise Ratio vs Supply Voltage

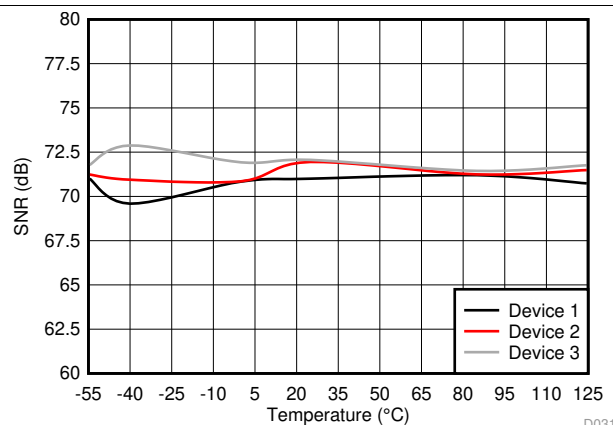

Figure 32. Signal-to-Noise Ratio vs Temperature

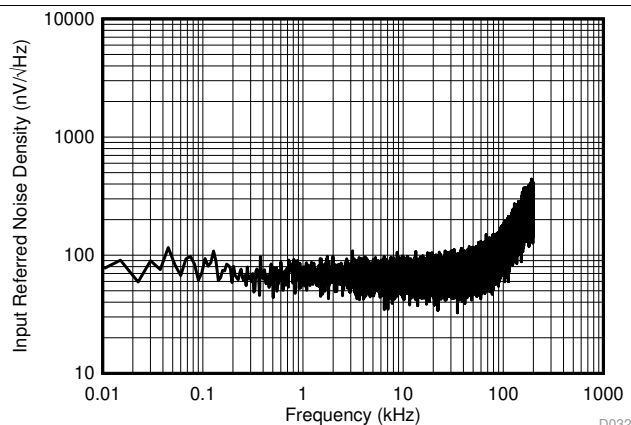

Figure 33. Input-Referred Noise Density vs Frequency

Typical Characteristics (continued)

at VDD1 = 5 V, VDD2 = 3.3 V, VINP = -250 mV to 250 mV, VINN = 0 V, and f<sub>IN</sub> = 10 kHz (unless otherwise noted)

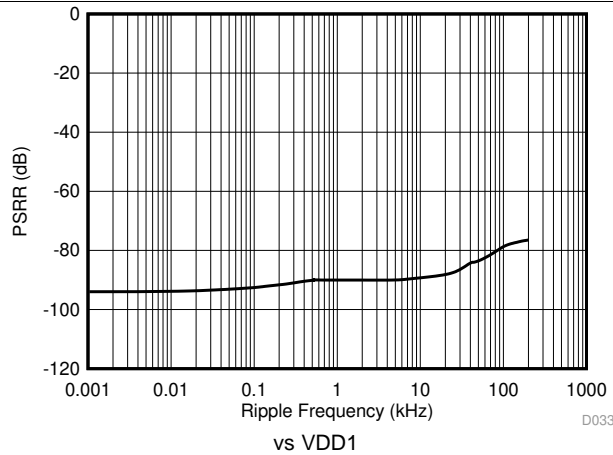

Figure 34. Power-Supply Rejection Ratio vs Ripple Frequency

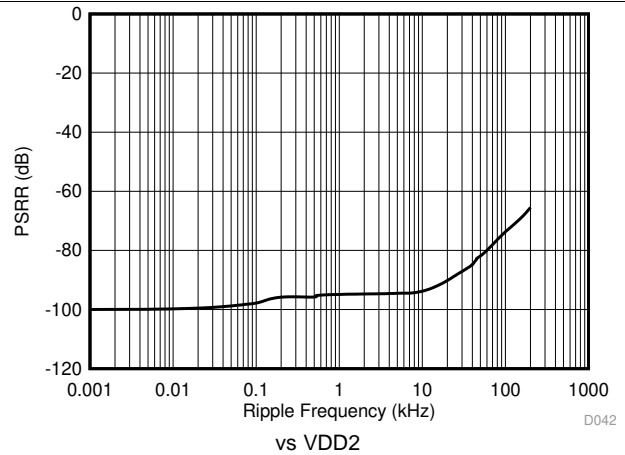

Figure 35. Power-Supply Rejection Ratio vs Ripple Frequency

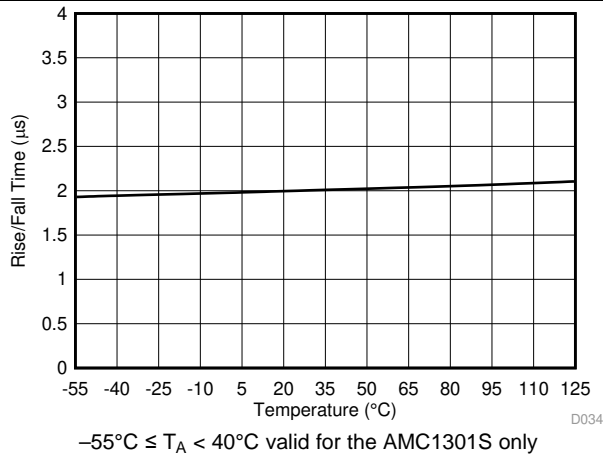

Figure 36. Output Rise and Fall Time vs Temperature

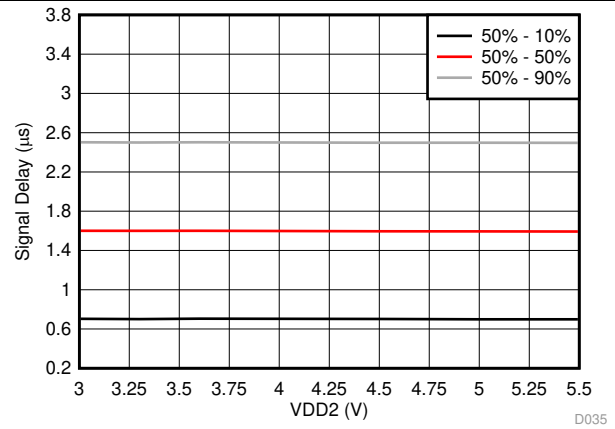

Figure 37. V<sub>IN</sub> to V<sub>OUT</sub> Signal Delay vs Low-Side Supply Voltage

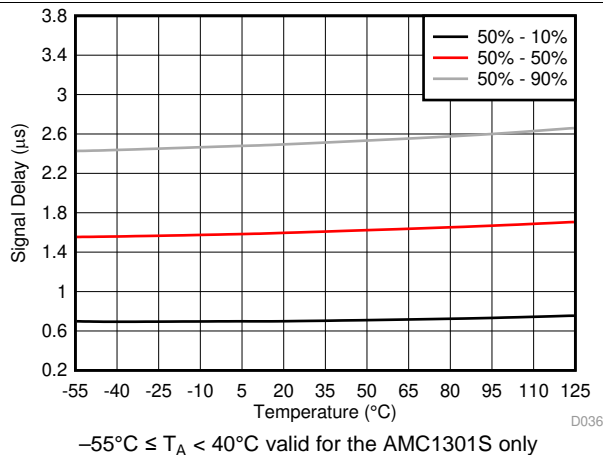

Figure 38. V<sub>IN</sub> to V<sub>OUT</sub> Signal Delay vs Temperature

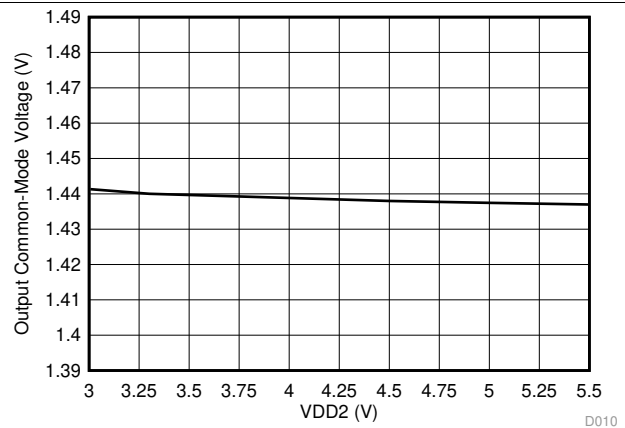

Figure 39. Output Common-Mode Voltage vs Low-Side Supply Voltage

### Typical Characteristics (continued)

at VDD1 = 5 V, VDD2 = 3.3 V, VINP = -250 mV to 250 mV, VINN = 0 V, and f<sub>IN</sub> = 10 kHz (unless otherwise noted)

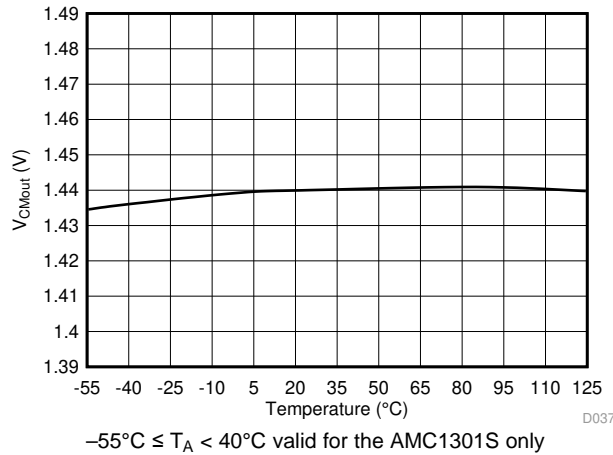

Figure 40. Output Common-Mode Voltage vs Temperature

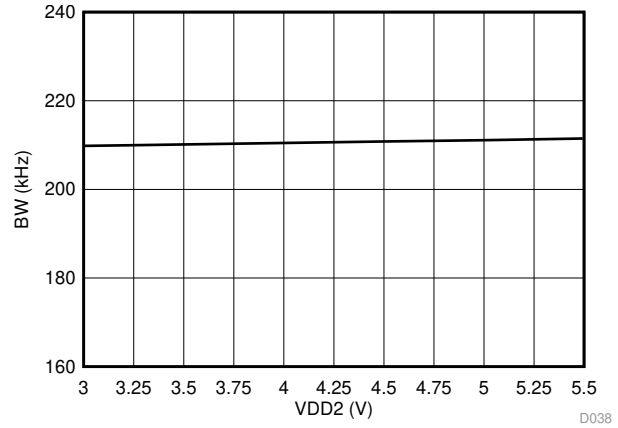

Figure 41. Output Bandwidth vs Low-Side Supply Voltage

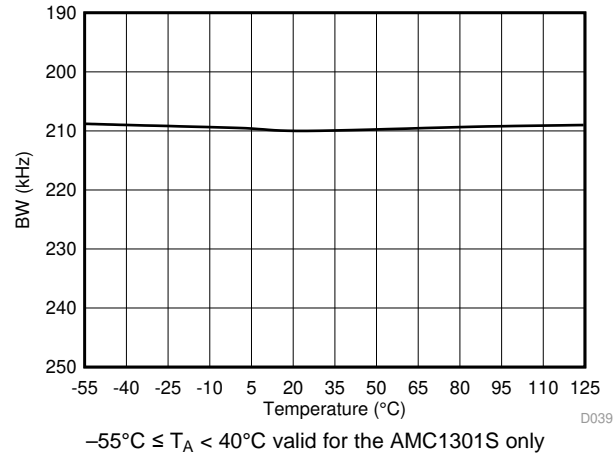

Figure 42. Output Bandwidth vs Temperature

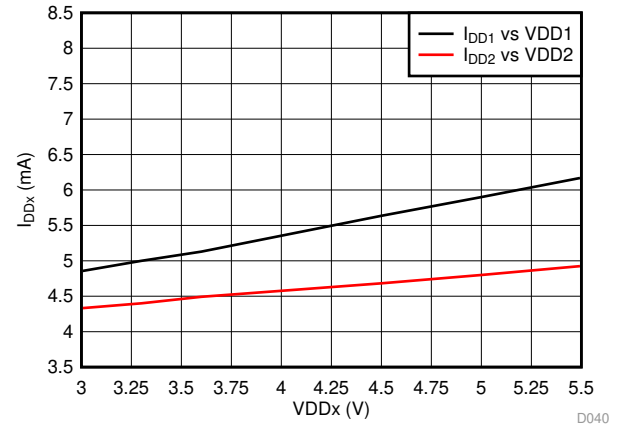

Figure 43. Supply Current vs Supply Voltage

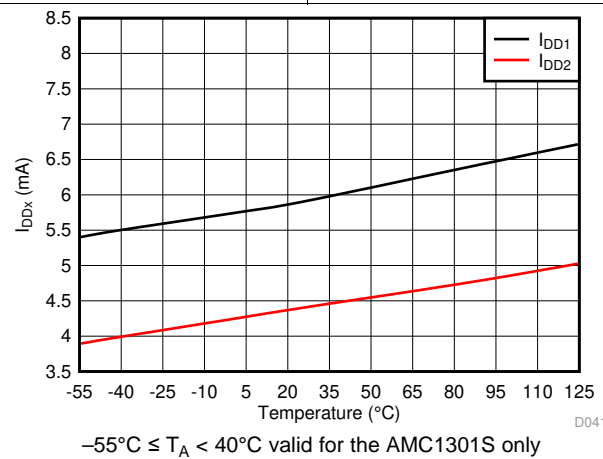

Figure 44. Supply Current vs Temperature



## 8 Parameter Measurement Information

### 8.1 Timing Diagrams

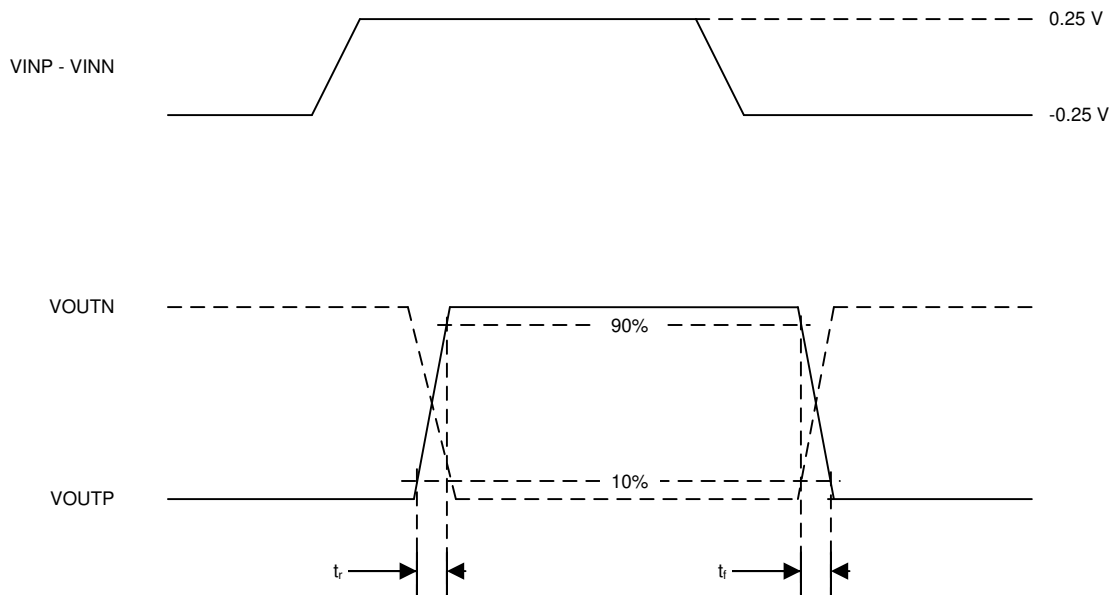

Figure 45. Rise and Fall Time Test Waveforms

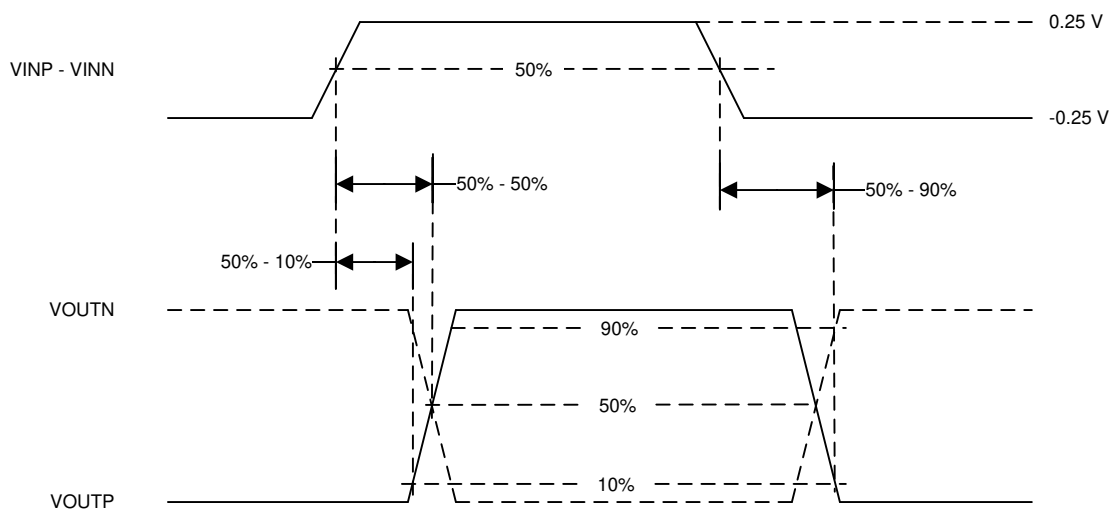

Figure 46. Delay Time Test Waveforms

## 9 Detailed Description

### 9.1 Overview

The AMC1301 is a fully-differential, precision, isolated amplifier. The input stage of the device consists of a fully-differential amplifier that drives a second-order, delta-sigma ( $\Delta\Sigma$ ) modulator. The modulator uses the internal voltage reference and clock generator to convert the analog input signal to a digital bitstream. The drivers (called TX in the *Functional Block Diagram*) transfer the output of the modulator across the isolation barrier that separates the high-side and low-side voltage domains. The received bitstream and clock are synchronized and processed by a fourth-order analog filter on the low-side and presented as a differential output of the device, as shown in the *Functional Block Diagram*.

The SiO<sub>2</sub>-based, double-capacitive isolation barrier supports a high level of magnetic field immunity, as described in *ISO72x Digital Isolator Magnetic-Field Immunity*. The digital modulation used in the AMC1301 and the isolation barrier characteristics result in high reliability and common-mode transient immunity.

### 9.2 Functional Block Diagram

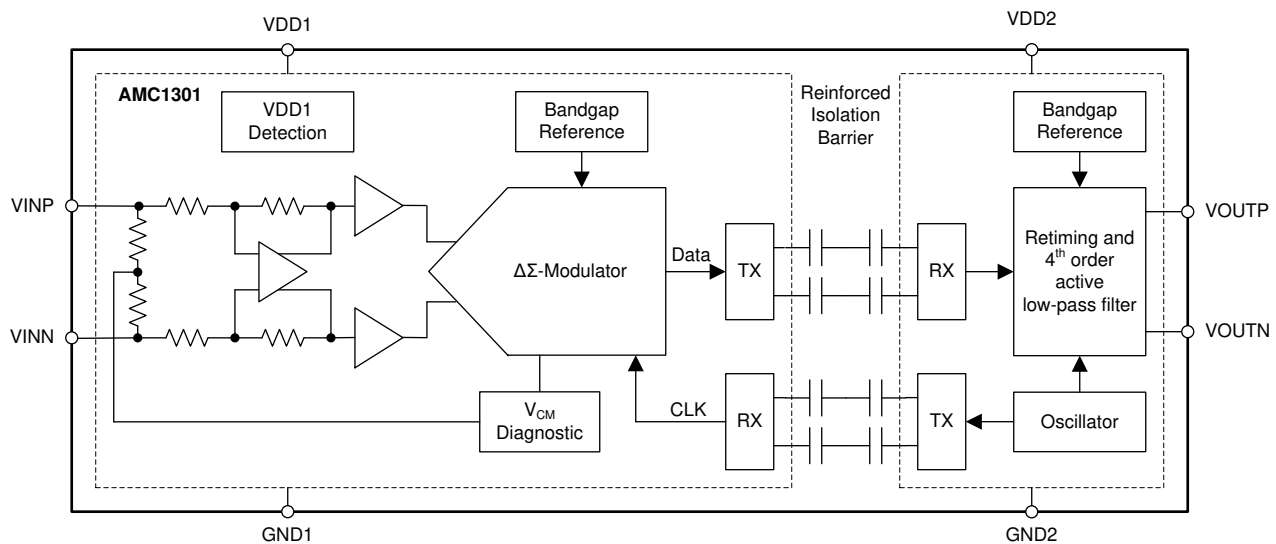

### 9.3 Feature Description

#### 9.3.1 Analog Input

The AMC1301 incorporates front-end circuitry that contains a fully-differential amplifier followed by a  $\Delta\Sigma$  modulator sampling stage. The gain of the differential amplifier is set by internal precision resistors to a factor of 4 with a differential input impedance of 22 k $\Omega$ . Consider the input impedance of the AMC1301 in designs with high-impedance signal sources that may cause degradation of gain and offset specifications. The importance of this effect, however, depends on the desired system performance.

Additionally, the input bias current caused by the internal common-mode voltage at the output of the differential amplifier causes an offset that is dependent on the actual amplitude of the input signal. See the *Isolated Voltage Sensing* section for more details on reducing this effect.

There are two restrictions on the analog input signals (VINP and VINN). First, if the input voltage exceeds the range GND1 – 6 V to VDD1 + 0.5 V, then the input current must be limited to 10 mA because the device input electrostatic discharge (ESD) protection turns on. In addition, the linearity and noise performance of the device are ensured only when the analog input voltage remains within the specified linear full-scale range (FSR) and within the specified common-mode input voltage range.

## Feature Description (continued)

### 9.3.2 Fail-Safe Output

The AMC1301 offers a fail-safe output that simplifies diagnostics on system level. The fail-safe output is active in two cases:

- When the high-side supply VDD1 of the AMC1301 is missing, or
- When the common-mode input voltage, that is  $V_{CM} = (VINP + VINN) / 2$ , exceeds the minimum common-mode over-voltage detection level  $V_{CMov}$  of  $VDD1 - 2 V$ .

The fail-safe output of the AMC1301 is a negative differential output voltage value that differs from the negative clipping output voltage, as shown in Figure 47 and Figure 48. As a reference value for the fail-safe detection on a system level, use the  $V_{FAILSAFE}$  maximum value of  $-2.545 V$ .

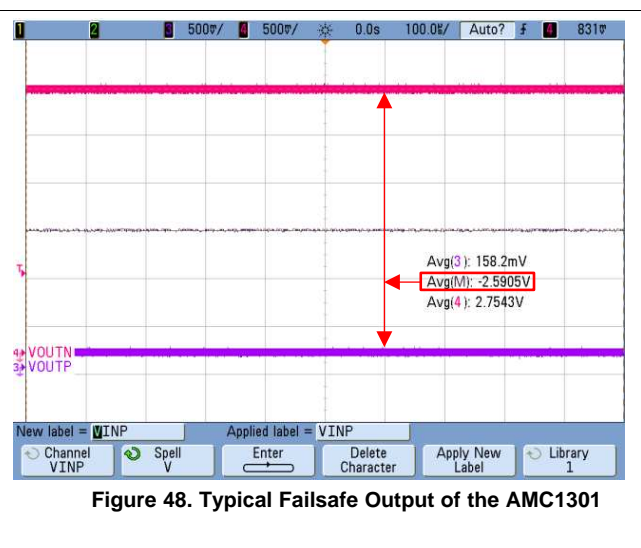
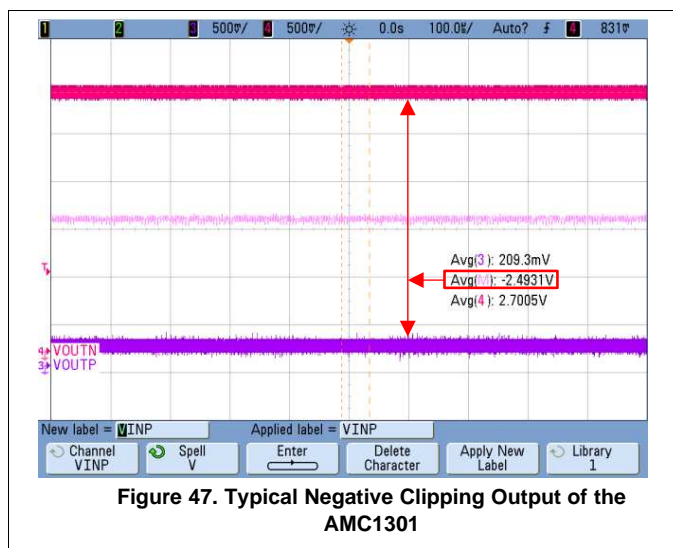

## 9.4 Device Functional Modes

The AMC1301 is operational when the power supplies VDD1 and VDD2 are applied, as specified in *Recommended Operating Conditions*.

## 10 Application and Implementation

### NOTE

Information in the following applications sections is not part of the TI component specification, and TI does not warrant its accuracy or completeness. TI's customers are responsible for determining suitability of components for their purposes. Customers should validate and test their design implementation to confirm system functionality.

### 10.1 Application Information

The AMC1301 offers unique linearity, high input common-mode and power-supply rejection, low ac and dc errors, and low temperature drift. These features make the AMC1301 a robust, high-performance, isolated amplifier for industrial applications where high voltage isolation is required.

### 10.2 Typical Applications

#### 10.2.1 Frequency Inverter Application

Isolated amplifiers are widely used in frequency inverters that are critical parts of industrial motor drives, photovoltaic inverters, uninterruptible power supplies, electrical and hybrid electrical vehicles, and other industrial applications. The input structure of the AMC1301 is optimized for use with low-value shunt resistors and is therefore tailored for isolated current sensing using shunts.

Figure 49 shows a typical operation of the AMC1301 for current sensing in a frequency inverter application. Phase current measurement is done through the shunt resistor,  $R_{SHUNT}$  (in this case, a two-pin shunt). The differential input and the high common-mode transient immunity of the AMC1301 ensure reliable and accurate operation even in high-noise environments (such as the power stage of the motor drive).

Additionally, the AMC1301 may also be used for isolated voltage measurement of the dc-link, as described in the [Isolated Voltage Sensing](#) section.

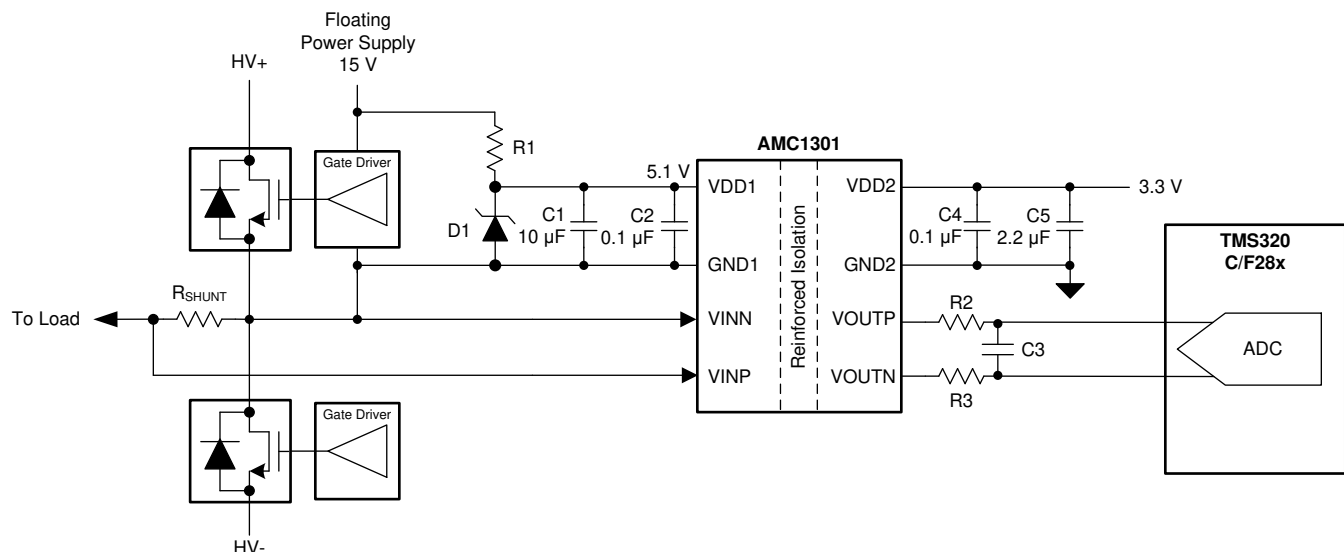

**Figure 49. Using the AMC1301 for Current Sensing in Frequency Inverters**

## Typical Applications (continued)

### 10.2.1.1 Design Requirements

Table 1 lists the parameters for the typical application in Figure 49.

**Table 1. Design Requirements**

PARAMETER	VALUE
High-side supply voltage	3.3 V or 5 V
Low-side supply voltage	3.3 V or 5 V
Voltage drop across the shunt for a linear response	± 250 mV (maximum)

### 10.2.1.2 Detailed Design Procedure

The high-side power supply (VDD1) for the AMC1301 is derived from the power supply of the upper gate driver. Further details are provided in the [Power Supply Recommendations](#) section.

The floating ground reference (GND1) is derived from one of the ends of the shunt resistor that is connected to the negative input of the AMC1301 (VINN). If a four-pin shunt is used, the inputs of the AMC1301 are connected to the inner leads and GND1 is connected to one of the outer shunt leads.

Use Ohm's Law to calculate the voltage drop across the shunt resistor ( $V_{SHUNT}$ ) for the desired measured current:  $V_{SHUNT} = I \times R_{SHUNT}$ .

Consider the following two restrictions to choose the proper value of the shunt resistor  $R_{SHUNT}$ :

- The voltage drop caused by the nominal current range must not exceed the recommended differential input voltage range:  $V_{SHUNT} \leq \pm 250$  mV
- The voltage drop caused by the maximum allowed overcurrent must not exceed the input voltage that causes a clipping output:  $V_{SHUNT} \leq V_{Clipping}$

For best performance, use an RC filter (components  $R_2$ ,  $R_3$ , and  $C_3$  in Figure 49) to minimize the noise of the differential output signal. Tailor the bandwidth of this RC filter to the bandwidth requirement of the system. TI recommends an NP0-type capacitor to be used for  $C_3$ .

For more information on the general procedure to design the filtering and driving stages of SAR ADCs, consult the TI Precision Designs [18-Bit, 1MSPS Data Acquisition Block \(DAQ\) Optimized for Lowest Distortion and Noise](#) and [18-Bit Data Acquisition Block \(DAQ\) Optimized for Lowest Power](#), available for download at [www.ti.com](http://www.ti.com).

### 10.2.1.3 Application Curves

In frequency inverter applications, the power switches must be protected in case of an overcurrent condition. To allow for fast powering off of the system, a low delay caused by the isolated amplifier is required. Figure 50 shows the typical full-scale step response of the AMC1301. Consider the delay of the required window comparator and the MCU to calculate the overall response time of the system.



Figure 50. Step Response of the AMC1301

The high linearity and low temperature drift of offset and gain errors of the AMC1301, as shown in Figure 51, allows design of motor drives with low torque ripple.

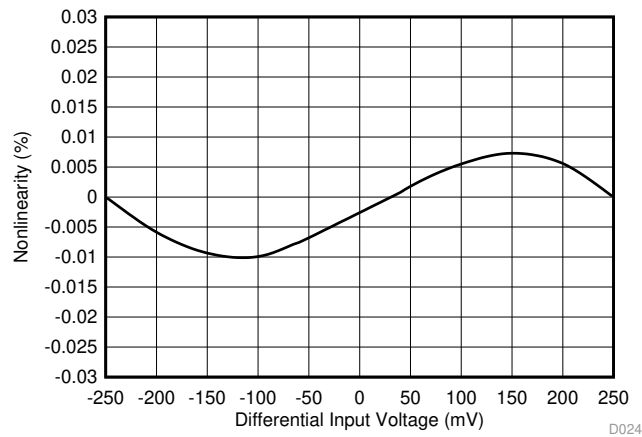

Figure 51. Typical Nonlinearity of the AMC1301

## 10.2.2 Isolated Voltage Sensing

The AMC1301 is optimized for usage in current-sensing applications using low-impedance shunts. However, the device may also be used in isolated voltage-sensing applications if the effect of the (usually higher) impedance of the resistor divider used in this case is considered.

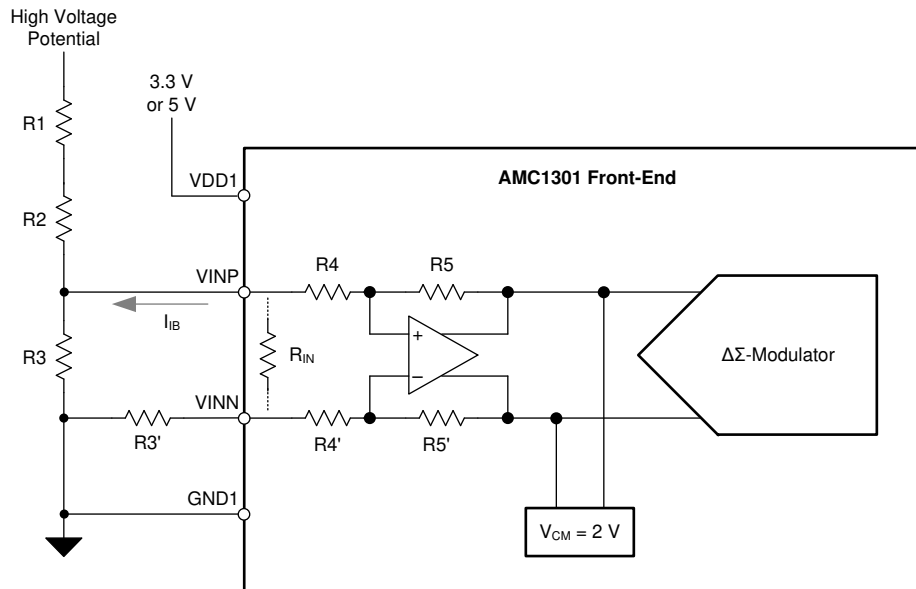

Figure 52. Using the AMC1301 for Isolated Voltage Sensing

### 10.2.2.1 Design Requirements

Figure 52 shows a simplified circuit typically used in high-voltage sensing applications. The high-impedance resistors (R1 and R2) dominate the current value that flows through the resistive divider. The resistance of the sensing resistor R3 is chosen to meet the input voltage range of the AMC1301. This resistor and the input impedance of the device ( $R_{IN} = 18\text{ k}\Omega$ ) also create a voltage divider that results in an additional gain error. With the assumption of R1 and R2 having a considerably higher value than R3 and omitting R3' for the moment, the resulting total gain error is estimated using Equation 1, with  $E_G$  being the initial gain error of the AMC1301.

$$|E_{Gtot}| = |E_G| + \frac{R_3}{R_{IN}} \quad (1)$$

This gain error may be easily minimized during the initial system-level gain calibration procedure.

### 10.2.2.2 Detailed Design Procedure

As indicated in Figure 52, the output of the integrated differential amplifier is internally biased to a common-mode voltage of 2 V. This voltage results in a bias current  $I_B$  through the resistive network R4 and R5 (or R4' and R5') used for setting the gain of the amplifier. The value of this current is specified in the [Pin Configuration and Functions](#) section. This bias current generates additional offset and gain errors that depend on the value of the resistor R3. Because the value of this bias current depends on the actual common-mode amplitude of the input signal (as shown in Figure 53), the initial system offset calibration eliminates the offset but not the gain error component. Therefore, in systems with high accuracy requirements, a series resistor is recommended to be used at the negative input (VINN) of the AMC1301 with a value equal to the shunt resistor R3 (that is,  $R3' = R3$  in Figure 52) to eliminate the effect of the bias current.

This additional series resistor (R3') influences the gain error of the circuit. The effect is calculated using Equation 2 with  $R4 = R4' = 12.5\text{ k}\Omega$ . The effect of the internal resistors  $R5 = R5'$  cancels in this calculation.

$$E_G(\%) = \left(1 - \frac{R4}{R4' + R3'}\right) * 100\% \quad (2)$$

### 10.2.2.3 Application Curve

Figure 53 shows the dependency of the input bias current on the common-mode voltage at the input of the AMC1301.

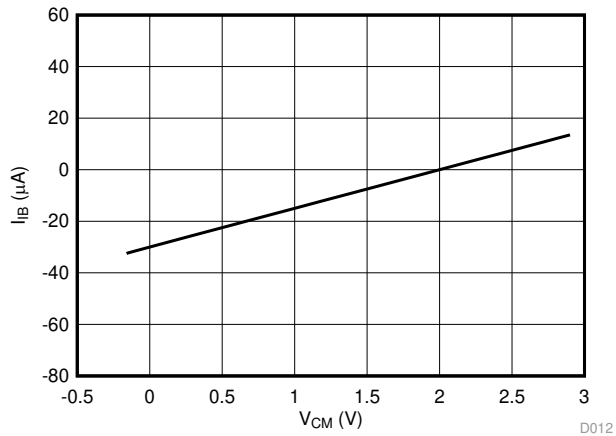

Figure 53. Input Current vs Input Common-Mode Voltage

### 10.3 What To Do and What Not TO Do

Do not leave the inputs of the AMC1301 unconnected (floating) when the device is powered up. If both device inputs are left floating, the input bias current drives them to the output common-mode of the analog front-end of approximately 2 V. If the high-side supply voltage VDD1 is below 4 V, the internal common-mode overvoltage detector turns on and the output functions as described in the *Fail-Safe Output* section, which may lead to an undesired reaction on the system level.



## 11 Power Supply Recommendations

In a typical frequency inverter application, the high-side power supply (VDD1) for the device is derived from the floating power supply of the upper gate driver. For lowest cost, a Zener diode may be used to limit the voltage to 5 V (or 3.3 V, depending on the design)  $\pm 10\%$ . Alternatively a low-cost, low-dropout (LDO) regulator (for example, the [LM317-N](#)) may be used to minimize noise on the power supply. TI recommends a low-ESR decoupling capacitor of 0.1  $\mu\text{F}$  to filter this power-supply path. Place this capacitor ( $C_2$  in [Figure 54](#)) as close as possible to the VDD1 pin of the AMC1301 for best performance. If better filtering is required, an additional 10- $\mu\text{F}$  capacitor may be used. The floating ground reference (GND1) is derived from the end of the shunt resistor, which is connected to the negative input (VINN) of the device. If a four-pin shunt is used, the device inputs are connected to the inner leads, and GND1 is connected to one of the outer leads of the shunt.

To decouple the digital power supply on the controller side, use a 0.1- $\mu\text{F}$  capacitor placed as close to the VDD2 pin of the AMC1301 as possible, followed by an additional capacitor from 1  $\mu\text{F}$  to 10  $\mu\text{F}$ .

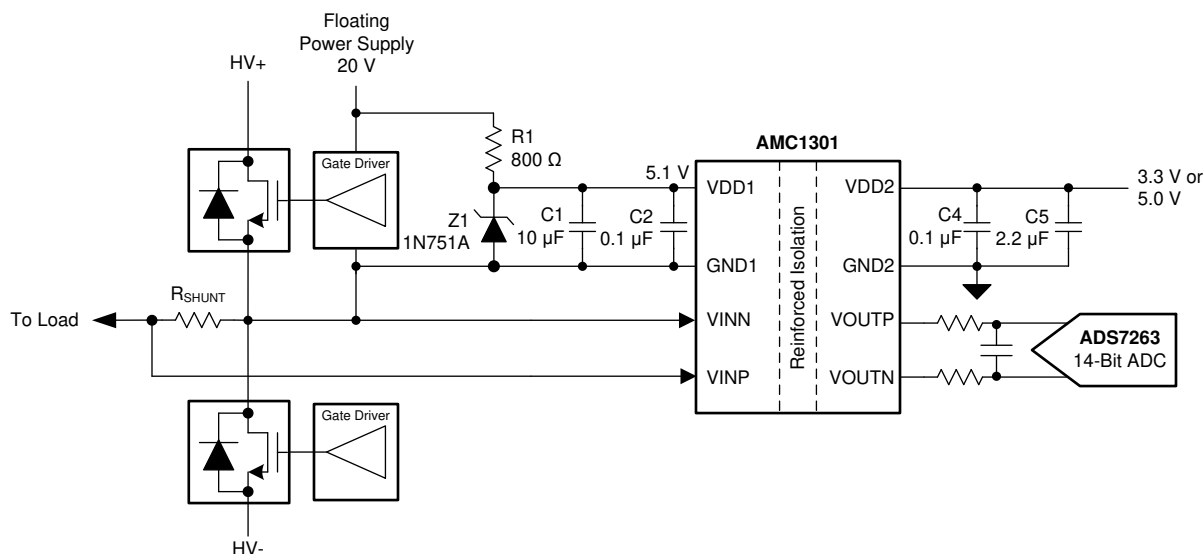

Figure 54. Zener-Diode-Based, High-Side Power Supply

## 12 Layout

### 12.1 Layout Guidelines

A layout recommendation showing the critical placement of the decoupling capacitors (as close as possible to the AMC1301) and placement of the other components required by the device is shown in [Figure 55](#). For best performance, place the shunt resistor close to the VINP and VINN inputs of the AMC1301 and keep the layout of both connections symmetrical.

### 12.2 Layout Example

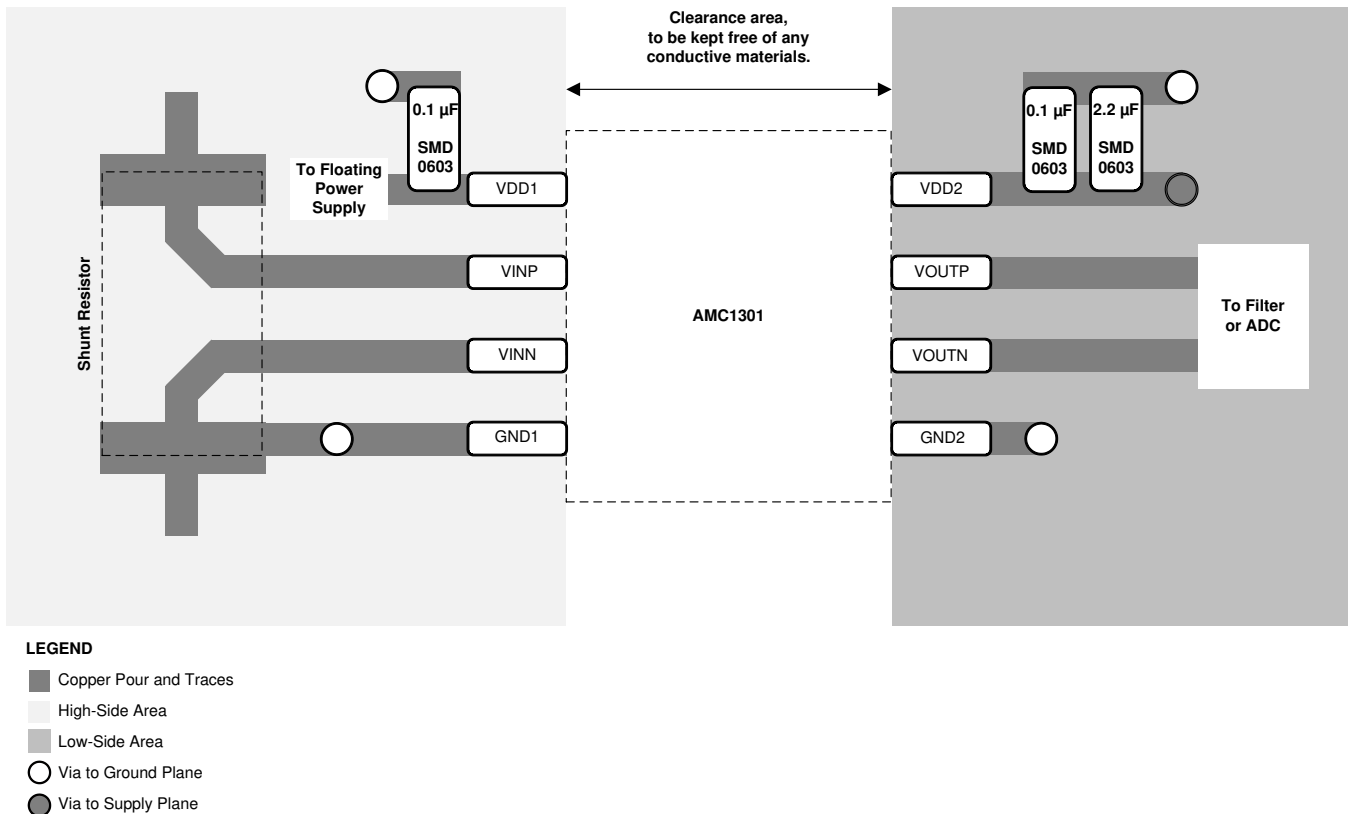

**Figure 55. Recommended Layout of the AMC1301**

## 13 Device and Documentation Support

### 13.1 Device Support

#### 13.1.1 Device Nomenclature

Texas Instruments, [Isolation Glossary](#)

### 13.2 Documentation Support

#### 13.2.1 Related Documentation

For related documentation, see the following:

- Texas Instruments, [Dual, 1MSPS, 16-/14-/12-Bit, 4x2 or 2x2 Channel, Simultaneous Sampling Analog-to-Digital Converter data sheet](#)
- Texas Instruments, [LM117, LM317-N Wide Temperature Three-Pin Adjustable Regulator data sheet](#)
- Texas Instruments, [ISO72x Digital Isolator Magnetic-Field Immunity application report](#)
- Texas Instruments, [18-Bit, 1-MSPS Data Acquisition Block \(DAQ\) Optimized for Lowest Distortion and Noise reference guide](#)
- Texas Instruments, [18-Bit, 1-MSPS Data Acquisition Block \(DAQ\) Optimized for Lowest Power reference guide](#)

### 13.3 Receiving Notification of Documentation Updates

To receive notification of documentation updates, navigate to the device product folder on ti.com. In the upper right corner, click on *Alert me* to register and receive a weekly digest of any product information that has changed. For change details, review the revision history included in any revised document.

### 13.4 Community Resources

TI E2E™ [support forums](#) are an engineer's go-to source for fast, verified answers and design help — straight from the experts. Search existing answers or ask your own question to get the quick design help you need.

Linked content is provided "AS IS" by the respective contributors. They do not constitute TI specifications and do not necessarily reflect TI's views; see TI's [Terms of Use](#).

### 13.5 Trademarks

E2E is a trademark of Texas Instruments.

All other trademarks are the property of their respective owners.

### 13.6 Electrostatic Discharge Caution



This integrated circuit can be damaged by ESD. Texas Instruments recommends that all integrated circuits be handled with appropriate precautions. Failure to observe proper handling and installation procedures can cause damage.

ESD damage can range from subtle performance degradation to complete device failure. Precision integrated circuits may be more susceptible to damage because very small parametric changes could cause the device not to meet its published specifications.

### 13.7 Glossary

[SLYZ022](#) — *TI Glossary*.

This glossary lists and explains terms, acronyms, and definitions.

## 14 Mechanical, Packaging, and Orderable Information

The following pages include mechanical, packaging, and orderable information. This information is the most current data available for the designated devices. This data is subject to change without notice and revision of this document. For browser-based versions of this data sheet, refer to the left-hand navigation.

**PACKAGING INFORMATION**

Orderable Device	Status (1)	Package Type	Package Drawing	Pins	Package Qty	Eco Plan (2)	Lead finish/ Ball material (6)	MSL Peak Temp (3)	Op Temp (°C)	Device Marking (4/5)	Samples
AMC1301DWV	ACTIVE	SOIC	DWV	8	64	RoHS & Green	NIPDAU	Level-3-260C-168 HR	-40 to 125	AMC1301	<a href="#">Samples</a>
AMC1301DWVR	ACTIVE	SOIC	DWV	8	1000	RoHS & Green	NIPDAU	Level-3-260C-168 HR	-40 to 125	AMC1301	<a href="#">Samples</a>
AMC1301SDWV	ACTIVE	SOIC	DWV	8	64	RoHS & Green	NIPDAU	Level-3-260C-168 HR	-55 to 125	AMC1301S	<a href="#">Samples</a>
AMC1301SDWVR	ACTIVE	SOIC	DWV	8	1000	RoHS & Green	NIPDAU	Level-3-260C-168 HR	-55 to 125	AMC1301S	<a href="#">Samples</a>

(1) The marketing status values are defined as follows:

**ACTIVE:** Product device recommended for new designs.

**LIFEBUY:** TI has announced that the device will be discontinued, and a lifetime-buy period is in effect.

**NRND:** Not recommended for new designs. Device is in production to support existing customers, but TI does not recommend using this part in a new design.

**PREVIEW:** Device has been announced but is not in production. Samples may or may not be available.

**OBSOLETE:** TI has discontinued the production of the device.

(2) **RoHS:** TI defines "RoHS" to mean semiconductor products that are compliant with the current EU RoHS requirements for all 10 RoHS substances, including the requirement that RoHS substance do not exceed 0.1% by weight in homogeneous materials. Where designed to be soldered at high temperatures, "RoHS" products are suitable for use in specified lead-free processes. TI may reference these types of products as "Pb-Free".

**RoHS Exempt:** TI defines "RoHS Exempt" to mean products that contain lead but are compliant with EU RoHS pursuant to a specific EU RoHS exemption.

**Green:** TI defines "Green" to mean the content of Chlorine (Cl) and Bromine (Br) based flame retardants meet JS709B low halogen requirements of <=1000ppm threshold. Antimony trioxide based flame retardants must also meet the <=1000ppm threshold requirement.

(3) MSL, Peak Temp. - The Moisture Sensitivity Level rating according to the JEDEC industry standard classifications, and peak solder temperature.

(4) There may be additional marking, which relates to the logo, the lot trace code information, or the environmental category on the device.

(5) Multiple Device Markings will be inside parentheses. Only one Device Marking contained in parentheses and separated by a "-" will appear on a device. If a line is indented then it is a continuation of the previous line and the two combined represent the entire Device Marking for that device.

(6) Lead finish/Ball material - Orderable Devices may have multiple material finish options. Finish options are separated by a vertical ruled line. Lead finish/Ball material values may wrap to two lines if the finish value exceeds the maximum column width.

**Important Information and Disclaimer:**The information provided on this page represents TI's knowledge and belief as of the date that it is provided. TI bases its knowledge and belief on information provided by third parties, and makes no representation or warranty as to the accuracy of such information. Efforts are underway to better integrate information from third parties. TI has taken and

continues to take reasonable steps to provide representative and accurate information but may not have conducted destructive testing or chemical analysis on incoming materials and chemicals. TI and TI suppliers consider certain information to be proprietary, and thus CAS numbers and other limited information may not be available for release.

In no event shall TI's liability arising out of such information exceed the total purchase price of the TI part(s) at issue in this document sold by TI to Customer on an annual basis.

**OTHER QUALIFIED VERSIONS OF AMC1301 :**

- Automotive: [AMC1301-Q1](#)

**NOTE: Qualified Version Definitions:**

- Automotive - Q100 devices qualified for high-reliability automotive applications targeting zero defects

**TAPE AND REEL INFORMATION**

**QUADRANT ASSIGNMENTS FOR PIN 1 ORIENTATION IN TAPE**

\*All dimensions are nominal

Device	Package Type	Package Drawing	Pins	SPQ	Reel Diameter (mm)	Reel Width W1 (mm)	A0 (mm)	B0 (mm)	K0 (mm)	P1 (mm)	W (mm)	Pin1 Quadrant
AMC1301DWVR	SOIC	DWV	8	1000	330.0	16.4	12.05	6.15	3.3	16.0	16.0	Q1
AMC1301SDWVR	SOIC	DWV	8	1000	330.0	16.4	12.05	6.15	3.3	16.0	16.0	Q1

**TAPE AND REEL BOX DIMENSIONS**

\*All dimensions are nominal

Device	Package Type	Package Drawing	Pins	SPQ	Length (mm)	Width (mm)	Height (mm)
AMC1301DWVR	SOIC	DWV	8	1000	350.0	350.0	43.0
AMC1301SDWVR	SOIC	DWV	8	1000	350.0	350.0	43.0

**TUBE**

\*All dimensions are nominal

Device	Package Name	Package Type	Pins	SPQ	L (mm)	W (mm)	T (μm)	B (mm)
AMC1301DWV	DWV	SOIC	8	64	505.46	13.94	4826	6.6
AMC1301SDWV	DWV	SOIC	8	64	505.46	13.94	4826	6.6





DWV0008A

SOIC - 2.8 mm max height

SOIC

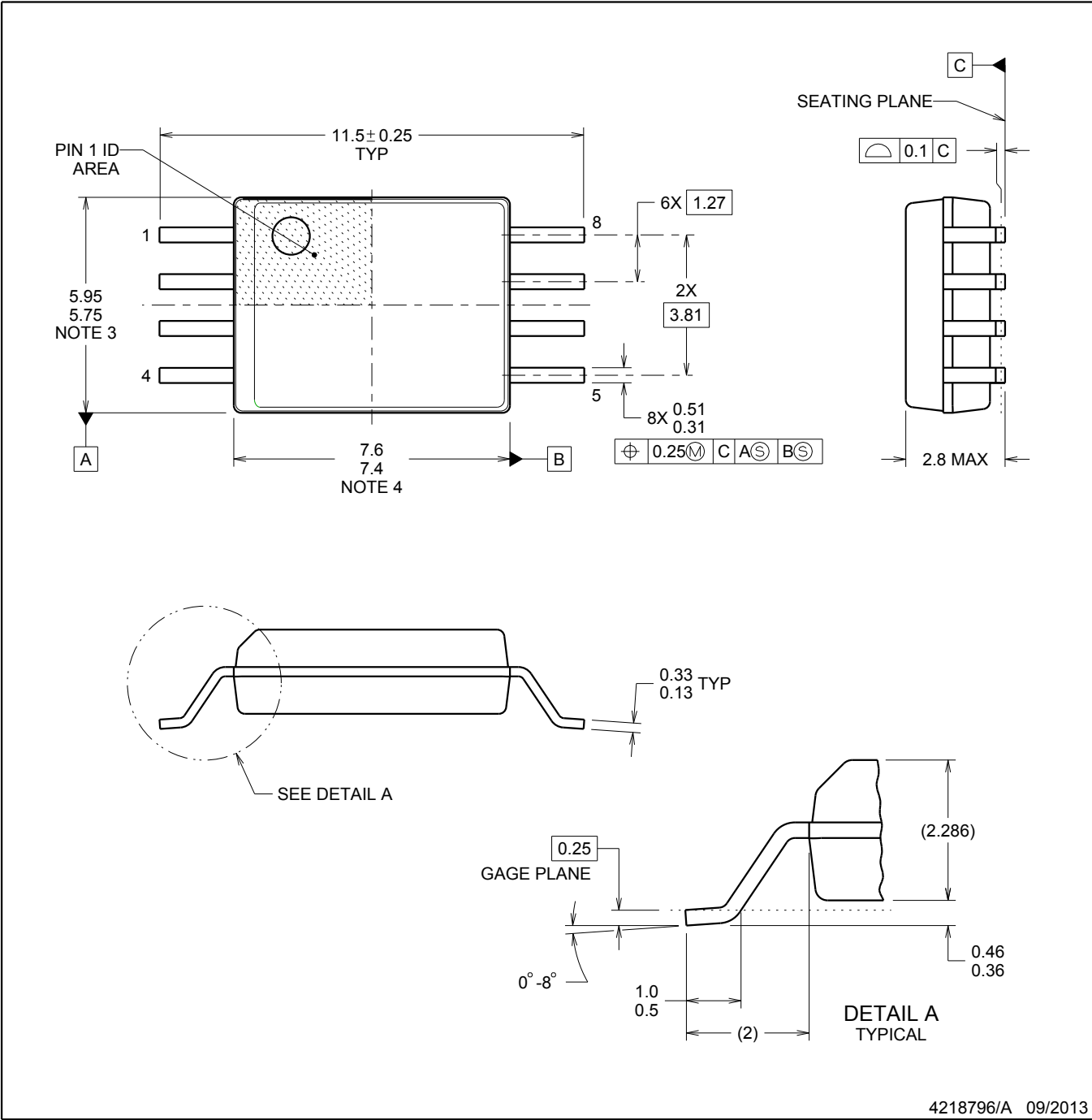

NOTES:

1. All linear dimensions are in millimeters. Dimensions in parenthesis are for reference only. Dimensioning and tolerancing per ASME Y14.5M.
2. This drawing is subject to change without notice.
3. This dimension does not include mold flash, protrusions, or gate burrs. Mold flash, protrusions, or gate burrs shall not exceed 0.15 mm, per side.
4. This dimension does not include interlead flash. Interlead flash shall not exceed 0.25 mm, per side.



LAND PATTERN EXAMPLE  
9.1 mm NOMINAL CLEARANCE/CREEPAGE  
SCALE:6X

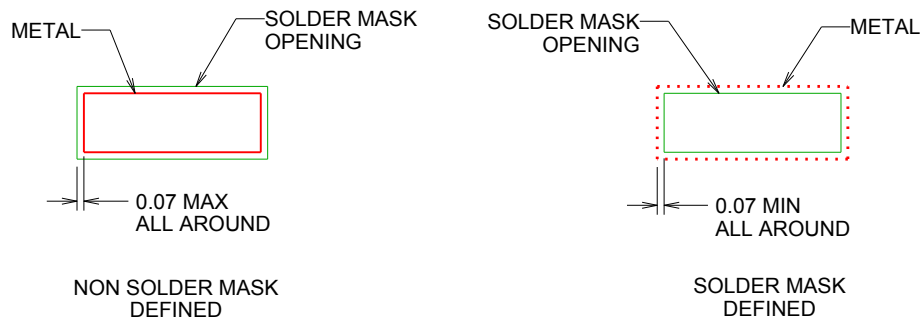

SOLDER MASK DETAILS

4218796/A 09/2013

NOTES: (continued)

- 5. Publication IPC-7351 may have alternate designs.
- 6. Solder mask tolerances between and around signal pads can vary based on board fabrication site.

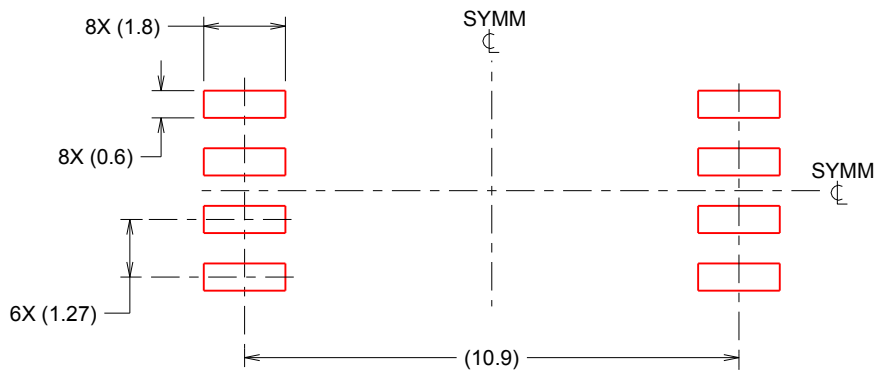

SOLDER PASTE EXAMPLE  
 BASED ON 0.125 mm THICK STENCIL  
 SCALE:6X

4218796/A 09/2013

NOTES: (continued)

- 7. Laser cutting apertures with trapezoidal walls and rounded corners may offer better paste release. IPC-7525 may have alternate design recommendations.
- 8. Board assembly site may have different recommendations for stencil design.

## IMPORTANT NOTICE AND DISCLAIMER

TI PROVIDES TECHNICAL AND RELIABILITY DATA (INCLUDING DATA SHEETS), DESIGN RESOURCES (INCLUDING REFERENCE DESIGNS), APPLICATION OR OTHER DESIGN ADVICE, WEB TOOLS, SAFETY INFORMATION, AND OTHER RESOURCES "AS IS" AND WITH ALL FAULTS, AND DISCLAIMS ALL WARRANTIES, EXPRESS AND IMPLIED, INCLUDING WITHOUT LIMITATION ANY IMPLIED WARRANTIES OF MERCHANTABILITY, FITNESS FOR A PARTICULAR PURPOSE OR NON-INFRINGEMENT OF THIRD PARTY INTELLECTUAL PROPERTY RIGHTS.

These resources are intended for skilled developers designing with TI products. You are solely responsible for (1) selecting the appropriate TI products for your application, (2) designing, validating and testing your application, and (3) ensuring your application meets applicable standards, and any other safety, security, regulatory or other requirements.

These resources are subject to change without notice. TI grants you permission to use these resources only for development of an application that uses the TI products described in the resource. Other reproduction and display of these resources is prohibited. No license is granted to any other TI intellectual property right or to any third party intellectual property right. TI disclaims responsibility for, and you will fully indemnify TI and its representatives against, any claims, damages, costs, losses, and liabilities arising out of your use of these resources.

TI's products are provided subject to [TI's Terms of Sale](#) or other applicable terms available either on [ti.com](http://ti.com) or provided in conjunction with such TI products. TI's provision of these resources does not expand or otherwise alter TI's applicable warranties or warranty disclaimers for TI products.

TI objects to and rejects any additional or different terms you may have proposed.

Mailing Address: Texas Instruments, Post Office Box 655303, Dallas, Texas 75265  
Copyright © 2022, Texas Instruments Incorporated