

Very low quiescent current dual voltage regulator

Datasheet - production data

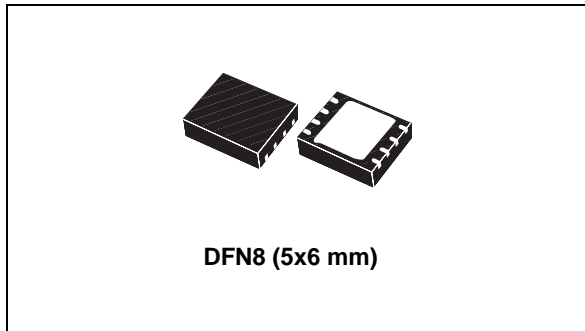

Description

Specifically designed for data storage applications, this device integrates two voltage regulators, each capable of supplying 1 A of current. It is assembled in an 8-pin DFN8 5x6 mm surface mounting package. One regulator block supplies 3.3 V and, on request, 1.5 V, 1.8 V, 2.5 V, 2.8 V and 3.0 V. The other is adjustable from 1.25 V to $V_1 - V_{\text{DROP}}$, which is suitable for powering several different types of microcontroller. Both outputs are current-limited and overtemperature protected. Also noteworthy is the very good thermal performance of the DFN package, with only 2 °C/W of thermal resistance junction-to-case.

Features

- V_{O1} : fixed
- V_{O2} : adjustable from 1.25 to $V_1 - V_{\text{DROP}}$
- Guaranteed current of output 1: 1 A
- Guaranteed current of output 2: 1 A
- $\pm 2\%$ output tolerance (at 25 °C)
- $\pm 3\%$ output tolerance at overtemperature
- Typical dropout 1.1 V ($I_{O1} = I_{O2} = 1$ A)
- Internal power and thermal limit
- Good stability with low ESR output capacitor
- Operating temperature range: 0 °C to 125 °C
- Very low quiescent current: 7 mA max overtemperature
- Available in DFN8 5x6 mm package

Applications

- Hard disk drives
- CD/DVD-ROMs
- CD/DVD-R/RWs
- COMBO® (DVD-ROM+CD-R/RW)

Table 1. Device summary

Order code	Package	Output voltage
ST2L05R3300PS	DFN8 (5x6 mm)	Adjustable

Contents

1	Block diagram	3
2	Pin configuration	4
3	Maximum ratings	5
4	Application circuits	6
5	Electrical characteristics	7
6	Application hints	15
6.1	External capacitors	15
6.2	Input capacitor	15
6.3	Output capacitor	15
6.4	Adjustable regulator	15
7	Typical characteristics	17
8	Package mechanical data	23
9	Different output voltage versions of the ST2L05-3300 available on request	26
10	Revision history	27

1 Block diagram

Figure 1. Block diagram of the fixed / adjustable output version of the ST2L05-3300

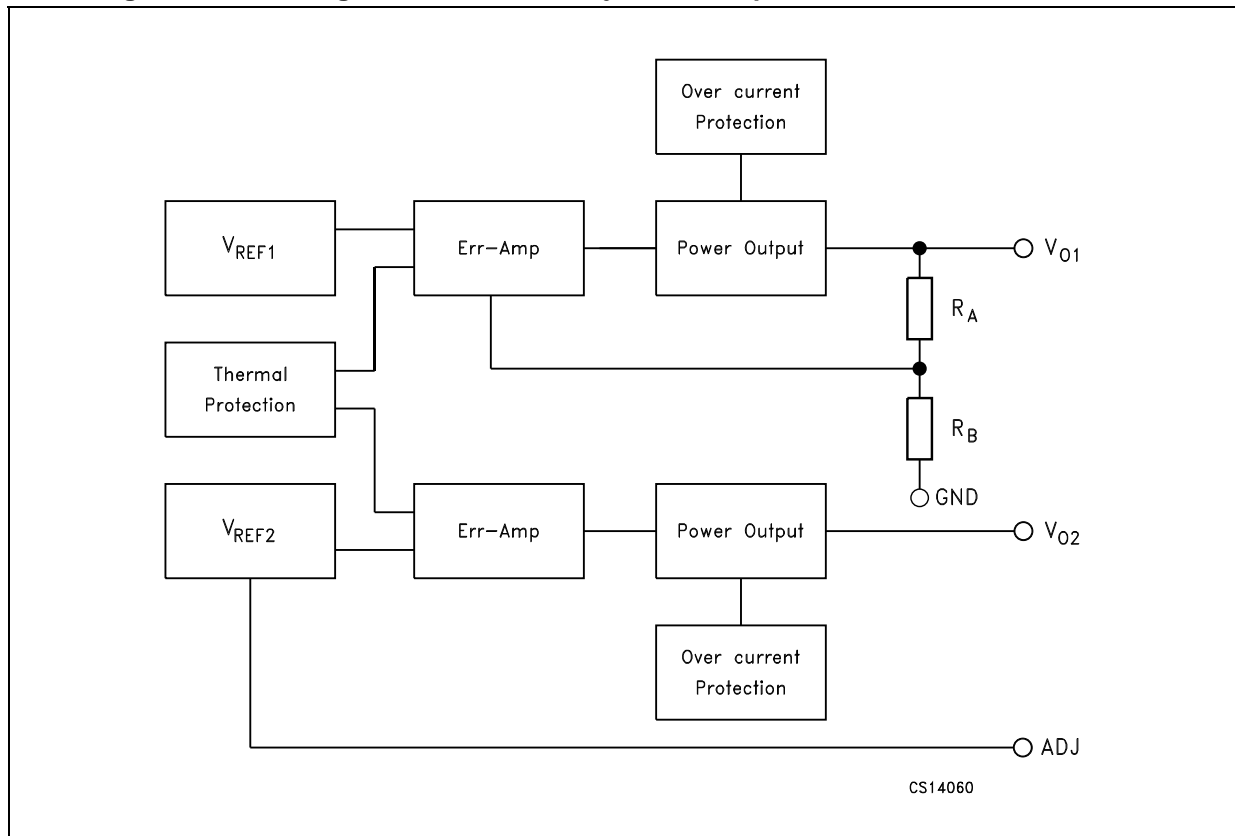

2 Pin configuration

Figure 2. Pin connection (top through view)

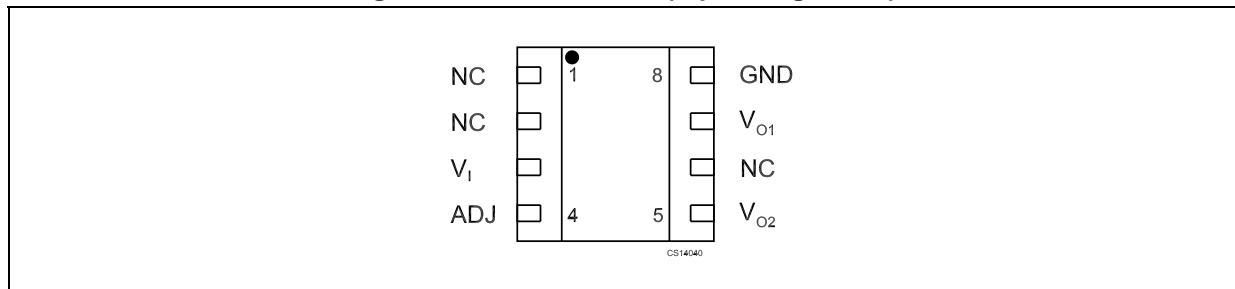

Table 2. Pin description

Pin n°	Symbol	Name and function
3	V ₁	Bypass with a 4.7 μF capacitor to GND
4	ADJ	Resistor divider connection
8	GND	Ground
5	V _{O2}	Adjustable output voltage: bypass with a 4.7 μF capacitor to GND
7	V _{O1}	Fixed output voltage: bypass with a 4.7 μF capacitor to GND
1, 2, 6	NC	Not connected

3 Maximum ratings

Table 3. Absolute maximum ratings

Symbol	Parameter	Value	Unit
V_I	Operating input voltage	10	V
P_D	Power dissipation	Internally limited	
I_{OSH}	Short circuit output current - 3.3 V and adjustable output	Internally limited	
T_{OP}	Operating junction temperature range	0 to 150	°C
T_{STG}	Storage temperature range ⁽¹⁾	- 65 to 150	°C
T_{LEAD}	Lead temperature (soldering) 10 sec.	260	°C

1. Storage temperatures > 125°C are only acceptable if the dual regulator is soldered to a PCBA.

Note: Absolute maximum ratings are those values beyond which damage to the device may occur. Functional operation under these condition is not implied.

Table 4. Recommended operating conditions

Symbol	Parameter	Value	Unit
V_I	Input voltage	4.5 to 7	V
ΔV_I	Input voltage ripple	± 0.15	V
t_{RISE}	Input voltage rise time (from 10% to 90%)	≥ 1	µs
t_{FALL}	Input voltage fall time (from 10% to 90%)	≥ 1	µs

Table 5. Thermal data

Symbol	Parameter	Value	Unit
R_{thJC}	Thermal resistance junction-case	2	°C/W
R_{thJA}	Thermal resistance junction-ambient	36	°C/W

4 Application circuits

Figure 3. Application circuit of fixed / adj. version (1)

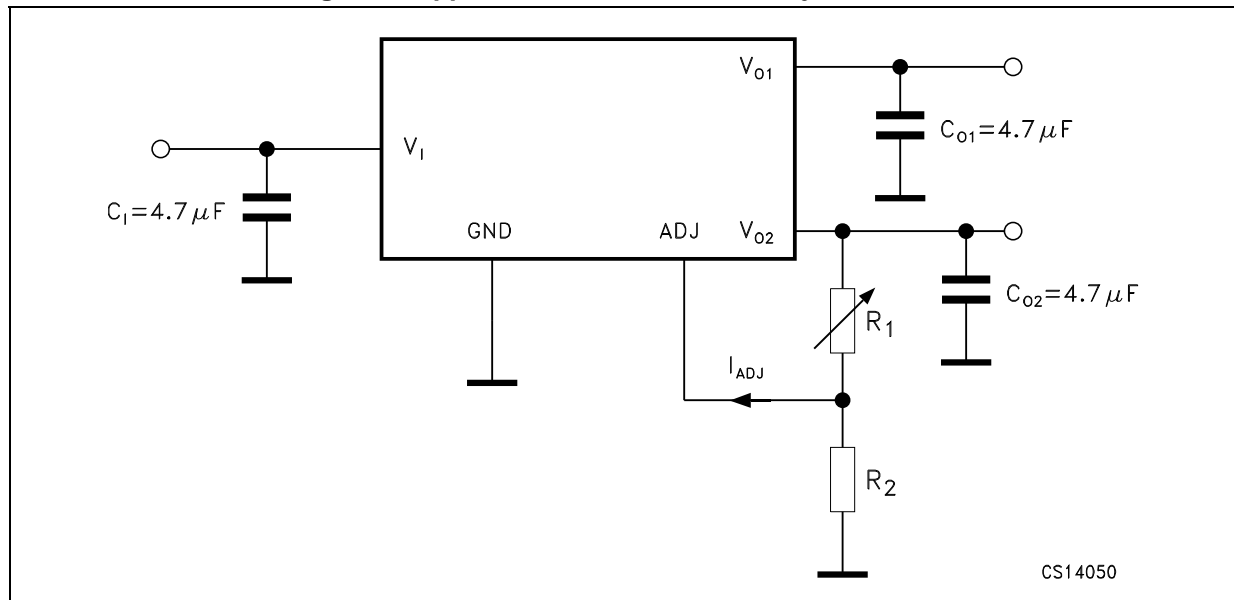

1. In the fixed / adj. version, the adjustable output voltage V_{O2} is designed to support output voltages from 1.25 V to $V_1 - V_{DROPO}$. The adjustable output voltage V_{O2} is set using a resistor divider connected between V_{O2} (pin 4) and ground (pin 3) with its center tap connected to V_{O2} ADJ (pin 2). The voltage divider resistors are: R_1 connected to V_{O2} and V_{O2} ADJ and R_2 connected to V_{O2} ADJ and GND. V_{O2} is determined by V_{REF} , R_1 , R_2 , and I_{ADJ} as follows (for more details see the application hints section):

$$V_{O2} = V_{REF} (1 + R_1 / R_2) + I_{ADJ} R_1$$

5 Electrical characteristics

$I_O = 10 \text{ mA to } 1 \text{ A}$, $T_J = 0 \text{ to } 125 \text{ }^\circ\text{C}$, $V_I = 4.5 \text{ V to } 7 \text{ V}$, $C_I = 4.7 \text{ } \mu\text{F}$, $C_{O1} = C_{O2} = 4.7 \text{ } \mu\text{F}$, unless otherwise specified.

Table 6. Output 1 and output 2 dual specification

Symbol	Parameter	Test conditions	Min.	Typ.	Max.	Unit
I_{GND}	Quiescent current (fixed / adj.)	$V_I \leq 7 \text{ V}$, $I_{\text{OUT}1,2} = 5 \text{ mA to } 1 \text{ A}$			5	mA
I_{ST}	Total current limit $I_{O1} + I_{O2}$		2			A
T_{SHDN}	Thermal shutdown			175		$^\circ\text{C}$
DT_{SHDN}	Thermal shutdown hysteresis			5		$^\circ\text{C}$

$I_O = 10 \text{ mA to } 1 \text{ A}$, $T_J = 0 \text{ to } 125 \text{ }^\circ\text{C}$, $V_I = 4.5 \text{ V to } 7 \text{ V}$, $C_1 = 4.7 \text{ } \mu\text{F}$, $C_{O1} = C_{O2} = 4.7 \text{ } \mu\text{F}$, unless otherwise specified.

Table 7. Electrical characteristics of fixed output 1.5 V

Symbol	Parameter	Test conditions	Min.	Typ.	Max.	Unit
V_O	Output voltage 1.5V	$I_O = 5\text{mA to } 1\text{A}$, $V_I = 4.75 \text{ to } 5.25\text{V}$ $T = 25^\circ\text{C}$	1.47	1.5	1.53	V
V_O	Output voltage 1.5V	$I_O = 5\text{mA to } 1\text{A}$, $V_I = 4.75 \text{ to } 5.25\text{V}$	1.455	1.5	1.545	V
ΔV_O	Line regulation	$V_I = 4.75 \text{ to } 5.25\text{V}$, $I_O = 5\text{mA to } 1\text{A}$			15	mV
ΔV_O	Load regulation	$V_I = 4.75\text{V}$, $I_O = 10\text{mA to } 1\text{A}$			12	mV
V_D	Dropout voltage $\Delta V_O = -1\%$	$I_O = 1\text{A}$			1.3	V
I_S	Current limit	$V_I = 5.5\text{V}$	1			A
$I_{O\text{MIN}}$	Min. output current for regulation				0	mA
e_N	RMS output noise ^{(1) (5)}	$T = 25^\circ\text{C}$		0.003		%
SVR	Supply voltage rejection ⁽²⁾⁽⁵⁾	$V_I = 5\text{V}$	60			dB
$\Delta V_O/\Delta I_O$	Transient response change of V_O with step load change ⁽³⁾⁽⁵⁾	$V_I = 5\text{V}$, $I_O = 1\text{mA to } 1\text{A}$, $t_r \geq 1\mu\text{s}$			$10^{(4)}$	%
		$V_I = 5\text{V}$, $I_O = 1\text{A to } 1\text{mA}$, $t_r \geq 1\mu\text{s}$			$10^{(4)}$	
$\Delta V_{O1}/\Delta V_I$	Transient response change of $V_{\text{OUT}1}$ with application of V_I ⁽³⁾⁽⁵⁾	0 to 5V step input, $I_O = 1\text{mA to } 1\text{A}$, $t_r \geq 1\mu\text{s}$			$10^{(4)}$	%
$\Delta V_O/\Delta I_O$	Transient response short circuit removal response ⁽³⁾⁽⁵⁾	$V_I = 5\text{V}$, $I_O = \text{short to } I_O = 10\text{mA}$			$20^{(4)}$	%
T_R	Thermal regulation ⁽⁵⁾	$I_O = 1\text{A}$, $t_{\text{PULSE}} = 30\text{ms}$		0.1		%/W
S	Temperature stability ⁽⁵⁾			0.5		%
S	Long-term stability ⁽⁵⁾ (1000hrs)	$T_J = 125^\circ\text{C}$		0.3		%

1. Bandwidth of 10 Hz to 10 kHz.
2. 120 Hz input ripple.
3. $C_1 = 20 \text{ } \mu\text{F}$, C_{O1} and $C_{O2} = 10 \text{ } \mu\text{F}$. C_1 , C_{O1} and C_{O2} are all X7R ceramic capacitors.
4. % undershoot or overshoot of V_O
5. Guaranteed by design, not tested in production.

$I_O = 10 \text{ mA to } 1 \text{ A}$, $T_J = 0 \text{ to } 125 \text{ }^\circ\text{C}$, $V_I = 4.5 \text{ V to } 7 \text{ V}$, $C_1 = 4.7 \text{ } \mu\text{F}$, $C_{O1} = C_{O2} = 4.7 \text{ } \mu\text{F}$, unless otherwise specified.

Table 8. Electrical characteristics of fixed output 1.8 V

Symbol	Parameter	Test conditions	Min.	Typ.	Max.	Unit
V_O	Output voltage 1.8V	$I_O = 5\text{mA to } 1\text{A}$, $V_I = 4.75 \text{ to } 5.25\text{V}$ $T = 25^\circ\text{C}$	1.764	1.8	1.836	V
V_O	Output voltage 1.8V	$I_O = 5\text{mA to } 1\text{A}$, $V_I = 4.75 \text{ to } 5.25\text{V}$	1.746	1.8	1.854	V
ΔV_O	Line regulation	$V_I = 4.75 \text{ to } 5.25\text{V}$, $I_O = 5\text{mA to } 1\text{A}$			15	mV
ΔV_O	Load regulation	$V_I = 4.75\text{V}$, $I_O = 10\text{mA to } 1\text{A}$			12	mV
V_D	Dropout voltage $\Delta V_O = -1\%$	$I_O = 1\text{A}$			1.3	V
I_S	Current limit	$V_I = 5.5\text{V}$	1			A
I_{OMIN}	Min. output current for regulation				0	mA
e_N	RMS output noise ^{(1) (5)}	$T = 25^\circ\text{C}$		0.003		%
SVR	Supply voltage rejection ⁽²⁾⁽⁵⁾	$V_I = 5\text{V}$	60			dB
$\Delta V_O/\Delta I_O$	Transient response change of V_O with step load change ⁽³⁾⁽⁵⁾	$V_I = 5\text{V}$, $I_O = 1\text{mA to } 1\text{A}$, $t_r \geq 1\mu\text{s}$			$10^{(4)}$	%
		$V_I = 5\text{V}$, $I_O = 1\text{A to } 1\text{mA}$, $t_r \geq 1\mu\text{s}$			$10^{(4)}$	
$\Delta V_{O1}/\Delta V_I$	Transient response change of V_{OUT1} with application of V_I ⁽³⁾⁽⁵⁾	0 to 5V step input, $I_O = 1\text{mA to } 1\text{A}$, $t_r \geq 1\mu\text{s}$			$10^{(4)}$	%
$\Delta V_O/\Delta I_O$	Transient response short circuit removal response ⁽³⁾⁽⁵⁾	$V_I = 5\text{V}$, $I_O = \text{short to } I_O = 10\text{mA}$			$20^{(4)}$	%
T_R	Thermal regulation ⁽⁵⁾	$I_O = 1\text{A}$, $t_{PULSE} = 30\text{ms}$		0.1		%/W
S	Temperature stability ⁽⁵⁾			0.5		%
S	Long-term stability ⁽⁵⁾ (1000hrs)	$T_J = 125^\circ\text{C}$		0.3		%

1. Bandwidth of 10 Hz to 10 kHz.
2. 120 Hz input ripple.
3. $C_1 = 20 \text{ } \mu\text{F}$, C_{O1} and $C_{O2} = 10 \text{ } \mu\text{F}$. C_1 , C_{O1} and C_{O2} are all X7R ceramic capacitors.
4. % undershoot or overshoot of V_O
5. Guaranteed by design, not tested in production.

$I_O = 10 \text{ mA to } 1 \text{ A}$, $T_J = 0 \text{ to } 125 \text{ }^\circ\text{C}$, $V_I = 4.5 \text{ V to } 7 \text{ V}$, $C_1 = 4.7 \text{ } \mu\text{F}$, $C_{O1} = C_{O2} = 4.7 \text{ } \mu\text{F}$, unless otherwise specified.

Table 9. Electrical characteristics of fixed output 2.5 V

Symbol	Parameter	Test conditions	Min.	Typ.	Max.	Unit
V_O	Output voltage 2.5V	$I_O = 5\text{mA to } 1\text{A}$, $V_I = 4.75 \text{ to } 5.25\text{V}$ $T = 25^\circ\text{C}$	2.45	2.5	2.55	V
V_O	Output voltage 2.5V	$I_O = 5\text{mA to } 1\text{A}$, $V_I = 4.75 \text{ to } 5.25\text{V}$	2.425	2.5	2.575	V
ΔV_O	Line regulation	$V_I = 4.75 \text{ to } 5.25\text{V}$, $I_O = 5\text{mA to } 1\text{A}$			15	mV
ΔV_O	Load regulation	$V_I = 4.75\text{V}$, $I_O = 10\text{mA to } 1\text{A}$			12	mV
V_D	Dropout voltage $\Delta V_O = -1\%$	$I_O = 1\text{A}$			1.3	V
I_S	Current limit	$V_I = 5.5\text{V}$	1			A
I_{OMIN}	Min. output current for regulation				0	mA
e_N	RMS output noise ^{(1) (5)}	$T = 25^\circ\text{C}$		0.003		%
SVR	Supply voltage rejection ⁽²⁾⁽⁵⁾	$V_I = 5\text{V}$	60			dB
$\Delta V_O/\Delta I_O$	Transient response change of V_O with step load change ⁽³⁾⁽⁵⁾	$V_I = 5\text{V}$, $I_O = 1\text{mA to } 1\text{A}$, $t_r \geq 1\mu\text{s}$			$10^{(4)}$	%
		$V_I = 5\text{V}$, $I_O = 1\text{A to } 1\text{mA}$, $t_r \geq 1\mu\text{s}$			$10^{(4)}$	
$\Delta V_{O1}/\Delta V_I$	Transient response change of V_{OUT1} with application of V_I ⁽³⁾⁽⁵⁾	0 to 5V step input, $I_O = 1\text{mA to } 1\text{A}$, $t_r \geq 1\mu\text{s}$			$10^{(4)}$	%
$\Delta V_O/\Delta I_O$	Transient response short circuit removal response ⁽³⁾⁽⁵⁾	$V_I = 5\text{V}$, $I_O = \text{short to } I_O = 10\text{mA}$			$20^{(4)}$	%
T_R	Thermal regulation ⁽⁵⁾	$I_O = 1\text{A}$, $t_{PULSE} = 30\text{ms}$		0.1		%/W
S	Temperature stability ⁽⁵⁾			0.5		%
S	Long-term stability ⁽⁵⁾ (1000hrs)	$T_J = 125^\circ\text{C}$		0.3		%

1. Bandwidth of 10 Hz to 10 kHz.
2. 120 Hz input ripple.
3. $C_1 = 20 \text{ } \mu\text{F}$, C_{O1} and $C_{O2} = 10 \text{ } \mu\text{F}$. C_1 , C_{O1} and C_{O2} are all X7R ceramic capacitors.
4. % undershoot or overshoot of V_O
5. Guaranteed by design, not tested in production.

$I_O = 10 \text{ mA to } 1 \text{ A}$, $T_J = 0 \text{ to } 125 \text{ }^\circ\text{C}$, $V_I = 4.5 \text{ V to } 7 \text{ V}$, $C_1 = 4.7 \text{ } \mu\text{F}$, $C_{O1} = C_{O2} = 4.7 \text{ } \mu\text{F}$, unless otherwise specified.

Table 10. Electrical characteristics of fixed output 2.8 V

Symbol	Parameter	Test conditions	Min.	Typ.	Max.	Unit
V_O	Output voltage 2.8V	$I_O = 5\text{mA to } 1\text{A}$, $V_I = 4.75 \text{ to } 5.25\text{V}$ $T = 25^\circ\text{C}$	2.744	2.8	2.856	V
V_O	Output voltage 2.8V	$I_O = 5\text{mA to } 1\text{A}$, $V_I = 4.75 \text{ to } 5.25\text{V}$	2.716	2.8	2.884	V
ΔV_O	Line regulation	$V_I = 4.75 \text{ to } 5.25\text{V}$, $I_O = 5\text{mA to } 1\text{A}$			15	mV
ΔV_O	Load regulation	$V_I = 4.75\text{V}$, $I_O = 10\text{mA to } 1\text{A}$			12	mV
V_D	Dropout voltage $\Delta V_O = -1\%$	$I_O = 1\text{A}$			1.3	V
I_S	Current limit	$V_I = 5.5\text{V}$	1			A
$I_{O\text{MIN}}$	Min. output current for regulation				0	mA
e_N	RMS output noise ^{(1) (5)}	$T = 25^\circ\text{C}$		0.003		%
SVR	Supply voltage rejection ⁽²⁾⁽⁵⁾	$V_I = 5\text{V}$	60			dB
$\Delta V_O/\Delta I_O$	Transient response change of V_O with step load change ⁽³⁾⁽⁵⁾	$V_I = 5\text{V}$, $I_O = 1\text{mA to } 1\text{A}$, $t_r \geq 1\mu\text{s}$			$10^{(4)}$	%
		$V_I = 5\text{V}$, $I_O = 1\text{A to } 1\text{mA}$, $t_r \geq 1\mu\text{s}$			$10^{(4)}$	
$\Delta V_{O1}/\Delta V_I$	Transient response change of $V_{O\text{UT}1}$ with application of V_I ⁽³⁾⁽⁵⁾	0 to 5V step input, $I_O = 1\text{mA to } 1\text{A}$, $t_r \geq 1\mu\text{s}$			$10^{(4)}$	%
$\Delta V_O/\Delta I_O$	Transient response short circuit removal response ⁽³⁾⁽⁵⁾	$V_I = 5\text{V}$, $I_O = \text{short to } I_O = 10\text{mA}$			$20^{(4)}$	%
T_R	Thermal regulation ⁽⁵⁾	$I_O = 1\text{A}$, $t_{\text{PULSE}} = 30\text{ms}$		0.1		%/W
S	Temperature stability ⁽⁵⁾			0.5		%
S	Long-term stability ⁽⁵⁾ (1000hrs)	$T_J = 125^\circ\text{C}$		0.3		%

1. Bandwidth of 10 Hz to 10 kHz.
2. 120 Hz input ripple.
3. $C_1 = 20 \text{ } \mu\text{F}$, C_{O1} and $C_{O2} = 10 \text{ } \mu\text{F}$. C_1 , C_{O1} and C_{O2} are all X7R ceramic capacitors.
4. % undershoot or overshoot of V_O
5. Guaranteed by design, not tested in production.

$I_O = 10 \text{ mA to } 1 \text{ A}$, $T_J = 0 \text{ to } 125 \text{ }^\circ\text{C}$, $V_I = 4.5 \text{ V to } 7 \text{ V}$, $C_1 = 4.7 \text{ } \mu\text{F}$, $C_{O1} = C_{O2} = 4.7 \text{ } \mu\text{F}$, unless otherwise specified.

Table 11. Electrical characteristics of fixed output 3.0 V

Symbol	Parameter	Test conditions	Min.	Typ.	Max.	Unit
V_O	Output voltage 3.0V	$I_O = 5\text{mA to } 1\text{A}$, $V_I = 4.75 \text{ to } 5.25\text{V}$ $T = 25^\circ\text{C}$	2.94	3.0	3.06	V
V_O	Output voltage 3.0V	$I_O = 5\text{mA to } 1\text{A}$, $V_I = 4.75 \text{ to } 5.25\text{V}$	2.91	3.0	3.09	V
ΔV_O	Line regulation	$V_I = 4.75 \text{ to } 5.25\text{V}$, $I_O = 5\text{mA to } 1\text{A}$			15	mV
ΔV_O	Load regulation	$V_I = 4.75\text{V}$, $I_O = 10\text{mA to } 1\text{A}$			12	mV
V_D	Dropout voltage $\Delta V_O = -1\%$	$I_O = 1\text{A}$			1.3	V
I_S	Current limit	$V_I = 5.5\text{V}$	1			A
I_{OMIN}	Min. output current for regulation				0	mA
e_N	RMS output noise ^{(1) (5)}	$T = 25^\circ\text{C}$		0.003		%
SVR	Supply voltage rejection ⁽²⁾⁽⁵⁾	$V_I = 5\text{V}$	60			dB
$\Delta V_O/\Delta I_O$	Transient response change of V_O with step load change ⁽³⁾⁽⁵⁾	$V_I = 5\text{V}$, $I_O = 1\text{mA to } 1\text{A}$, $t_r \geq 1\mu\text{s}$			$10^{(4)}$	%
		$V_I = 5\text{V}$, $I_O = 1\text{A to } 1\text{mA}$, $t_r \geq 1\mu\text{s}$			$10^{(4)}$	
$\Delta V_{O1}/\Delta V_I$	Transient response change of V_{OUT1} with application of V_I ⁽³⁾⁽⁵⁾	0 to 5V step input, $I_O = 1\text{mA to } 1\text{A}$, $t_r \geq 1\mu\text{s}$			$10^{(4)}$	%
$\Delta V_O/\Delta I_O$	Transient response short circuit removal response ⁽³⁾⁽⁵⁾	$V_I = 5\text{V}$, $I_O = \text{short to } I_O = 10\text{mA}$			$20^{(4)}$	%
T_R	Thermal regulation ⁽⁵⁾	$I_O = 1\text{A}$, $t_{PULSE} = 30\text{ms}$		0.1		%/W
S	Temperature stability ⁽⁵⁾			0.5		%
S	Long-term stability ⁽⁵⁾ (1000hrs)	$T_J = 125^\circ\text{C}$		0.3		%

1. Bandwidth of 10 Hz to 10 kHz.
2. 120 Hz input ripple.
3. $C_1 = 20 \text{ } \mu\text{F}$, C_{O1} and $C_{O2} = 10 \text{ } \mu\text{F}$. C_1 , C_{O1} and C_{O2} are all X7R ceramic capacitors.
4. % undershoot or overshoot of V_O
5. Guaranteed by design, not tested in production.

$I_O = 10 \text{ mA to } 1 \text{ A}$, $T_J = 0 \text{ to } 125 \text{ }^\circ\text{C}$, $V_I = 4.5 \text{ V to } 7 \text{ V}$, $C_1 = 4.7 \text{ } \mu\text{F}$, $C_{O1} = C_{O2} = 4.7 \text{ } \mu\text{F}$, unless otherwise specified.

Table 12. Electrical characteristics of fixed output 3.3 V

Symbol	Parameter	Test Conditions	Min.	Typ.	Max.	Unit
V_O	Output voltage 3.3V	$I_O = 5\text{mA to } 1\text{A}$, $V_I = 4.75 \text{ to } 5.25\text{V}$ $T = 25^\circ\text{C}$	3.234	3.3	3.366	V
V_O	Output voltage 3.3V	$I_O = 5\text{mA to } 1\text{A}$, $V_I = 4.75 \text{ to } 5.25\text{V}$	3.2	3.3	3.4	V
ΔV_O	Line regulation	$V_I = 4.75 \text{ to } 5.25\text{V}$, $I_O = 5\text{mA to } 1\text{A}$			15	mV
ΔV_O	Load regulation	$V_I = 4.75\text{V}$, $I_O = 10\text{mA to } 1\text{A}$			12	mV
V_D	Dropout voltage $\Delta V_O = -1\%$	$I_O = 1\text{A}$			1.3	V
I_S	Current limit	$V_I = 5.5\text{V}$	1			A
I_{OMIN}	Min. output current for regulation				0	mA
e_N	RMS output noise ^{(1) (5)}	$T = 25^\circ\text{C}$		0.003		%
SVR	Supply voltage rejection ⁽²⁾⁽⁵⁾	$V_I = 5\text{V}$	60			dB
$\Delta V_O/\Delta I_O$	Transient response change of V_O with step load change ⁽³⁾⁽⁵⁾	$V_I = 5\text{V}$, $I_O = 1\text{mA to } 1\text{A}$, $t_r \geq 1\mu\text{s}$			$10^{(4)}$	%
		$V_I = 5\text{V}$, $I_O = 1\text{A to } 1\text{mA}$, $t_r \geq 1\mu\text{s}$			$10^{(4)}$	
$\Delta V_{O1}/\Delta V_I$	Transient response change of V_{OUT1} with application of V_I ⁽³⁾⁽⁵⁾	0 to 5V step input, $I_O = 1\text{mA to } 1\text{A}$, $t_r \geq 1\mu\text{s}$			$10^{(4)}$	%
$\Delta V_O/\Delta I_O$	Transient response short circuit removal response ⁽³⁾⁽⁵⁾	$V_I = 5\text{V}$, $I_O = \text{short to } I_O = 10\text{mA}$			$20^{(4)}$	%
T_R	Thermal regulation ⁽⁵⁾	$I_O = 1\text{A}$, $t_{PULSE} = 30\text{ms}$		0.1		%/W
S	Temperature stability ⁽⁵⁾			0.5		%
S	Long-term stability ⁽⁵⁾ (1000hrs)	$T_J = 125^\circ\text{C}$		0.3		%

1. Bandwidth of 10 Hz to 10 kHz.
2. 120 Hz input ripple.
3. $C_1 = 20 \text{ } \mu\text{F}$, C_{O1} and $C_{O2} = 10 \text{ } \mu\text{F}$. C_1 , C_{O1} and C_{O2} are all X7R ceramic capacitors.
4. % undershoot or overshoot of V_O
5. Guaranteed by design, not tested in production.

$I_O = 10 \text{ mA to } 1 \text{ A}$, $T_J = 0 \text{ to } 125 \text{ }^\circ\text{C}$, $V_I = 4.5 \text{ V to } 7 \text{ V}$, $C_I = 4.7 \text{ } \mu\text{F}$, $C_{O1} = C_{O2} = 4.7 \text{ } \mu\text{F}$, unless otherwise specified.

Table 13. Electrical characteristics of adjustable output

Symbol	Parameter	Test conditions	Min.	Typ.	Max.	Unit
V_O	Reference voltage	$I_O = 5\text{mA to } 1\text{A}$, $V_I = 4.75 \text{ to } 5.25\text{V}$, $T = 25^\circ\text{C}$	1.225	1.25	1.275	V
V_O	Reference voltage	$I_O = 5\text{mA to } 1\text{A}$, $V_I = 4.75 \text{ to } 5.25\text{V}$	1.212	1.25	1.287	V
ΔV_{O2}	Line regulation 2	$V_I = 4.75 \text{ to } 5.25\text{V}$, $I_O = 5\text{mA to } 1\text{A}$			0.35	%
ΔV_{O2}	Load regulation 2	$V_I = 4.75\text{V}$, $I_O = 10\text{mA to } 1\text{A}$			0.4	%
V_D	Dropout voltage $\Delta V_O = -1\%$	$I_O = 1\text{A}$			1.3	V
I_S	Current limit	$V_I = 5.5\text{V}$	1			A
I_{ADJ}	Adjustable current (sinking)				1	μA
$I_{\Delta ADJ}$	Adjustable current change	$I_O = 10\text{mA to } 1\text{A}$			200	nA
I_{OMIN}	Min. output current for regulation				2	mA
e_N	RMS output noise ^{(1) (5)}	$T = 25^\circ\text{C}$		0.003		%
SVR	Supply voltage rejection ⁽²⁾⁽⁵⁾	$V_I = 5\text{V}$	60			dB
$\Delta V_{O2}/\Delta I_O$ 2	Transient response change of V_O with step load change ⁽³⁾⁽⁵⁾	$V_I = 5\text{V}$, $I_O = 1\text{mA to } 1\text{A}$, $t_r \geq 1\mu\text{s}$			$10^{(4)}$	%
		$V_I = 5\text{V}$, $I_O = 1\text{A to } 1\text{mA}$, $t_r \geq 1\mu\text{s}$			$10^{(4)}$	
$\Delta V_{O2}/\Delta V_I$	Transient response change of V_{OUT1} with application of V_I ⁽³⁾⁽⁵⁾	0 to 5V step input, $I_O = 1\text{mA to } 1\text{A}$, $t_r \geq 1\mu\text{s}$			$10^{(4)}$	%
$\Delta V_{O2}/\Delta I_O$ 2	Transient response short circuit removal response ⁽³⁾⁽⁵⁾	$V_I = 5\text{V}$, $I_O = \text{short to } I_O = 10\text{mA}$			$20^{(4)}$	%
T_R	Thermal regulation ⁽⁵⁾	$I_O = 1\text{A}$, $t_{PULSE} = 30\text{ms}$		0.1		%/W
S	Temperature stability ⁽⁵⁾			0.5		%
S	Long-term stability ⁽⁵⁾ (1000hrs)	$T_J = 125^\circ\text{C}$		0.3		%

1. Bandwidth of 10 Hz to 10 kHz.
2. 120 Hz input ripple.
3. $C_I = 20 \text{ } \mu\text{F}$, C_{O1} and $C_{O2} = 10 \text{ } \mu\text{F}$. C_I , C_{O1} and C_{O2} are all X7R ceramic capacitors.
4. % undershoot or overshoot of V_O
5. Guaranteed by design, not tested in production.

6 Application hints

6.1 External capacitors

Like any low-dropout regulator, the ST2L05-3300 requires external capacitors for stability. It is recommended to solder both capacitors as close as possible to the relative pins (1, 4 and 5).

6.2 Input capacitor

An input capacitor with a value of at least 2.2 μF is required. The amount of input capacitance can be increased without limit if a good quality tantalum or aluminium capacitor is used. SMD X7R or Y5V ceramic multilayer capacitors may not ensure stability in any condition due to the variability of their frequency and temperature characteristics. The use of this capacitor type is strictly related to the use of the output capacitors. For additional details, please read the [Output capacitor](#) section below. The input capacitor must be located at a distance of not more than 0.5" from the input pin of the device and returned to a clean analog ground.

6.3 Output capacitor

The ST2L05-3300 is designed specifically to work with ceramic and tantalum capacitors. Special care must be taken when a ceramic multilayer capacitor is used. Due to their characteristics, this type of capacitor can sometimes have an ESR value lower than the minimum required by the ST2L05-3300, and their relatively large capacitance can vary greatly depending on the ambient temperature. The test results for the stability of the ST2L05-3300 using multilayer ceramic capacitors show that a minimum value of 2.2 μF is needed for both regulators. This value can be increased without limit if the input capacitor value is greater than or equal to 4.7 μF , and up to 10 μF if the input capacitor is less than 4.7 μF . Surface-mountable solid tantalum capacitors offer a good combination of small physical size, capacitance value and ESR in the range needed for the ST2L05-3300. Test results show good stability for both outputs with values of at least 1 μF . The value can be increased without limit for even better performance in areas such as transient response and noise.

Important:

The output capacitor must maintain an ESR in the stable region over the full operating temperature to assure stability. Moreover, capacitor tolerance and variations due to temperature must be considered to assure that the minimum amount of capacitance is provided at all times. For this reason, when a ceramic multilayer capacitor is used, the better choice for temperature coefficient is the X7R type, which holds the capacitance within $\pm 15\%$. The output capacitor should be located not more than 0.5" from the output pins of the device and returned to a clean analog ground.

6.4 Adjustable regulator

The ST2L05-3300 has a 1.25 V reference voltage between the output and the adjust pin (pins 4 and 2, respectively). When resistor R_1 is placed between these two terminals, a constant current flows through R_1 and down to R_2 to set the overall (V_{O2} to GND) output voltage. Minimum load current is 2 mA max in all temperature conditions.

Figure 4. Application circuit

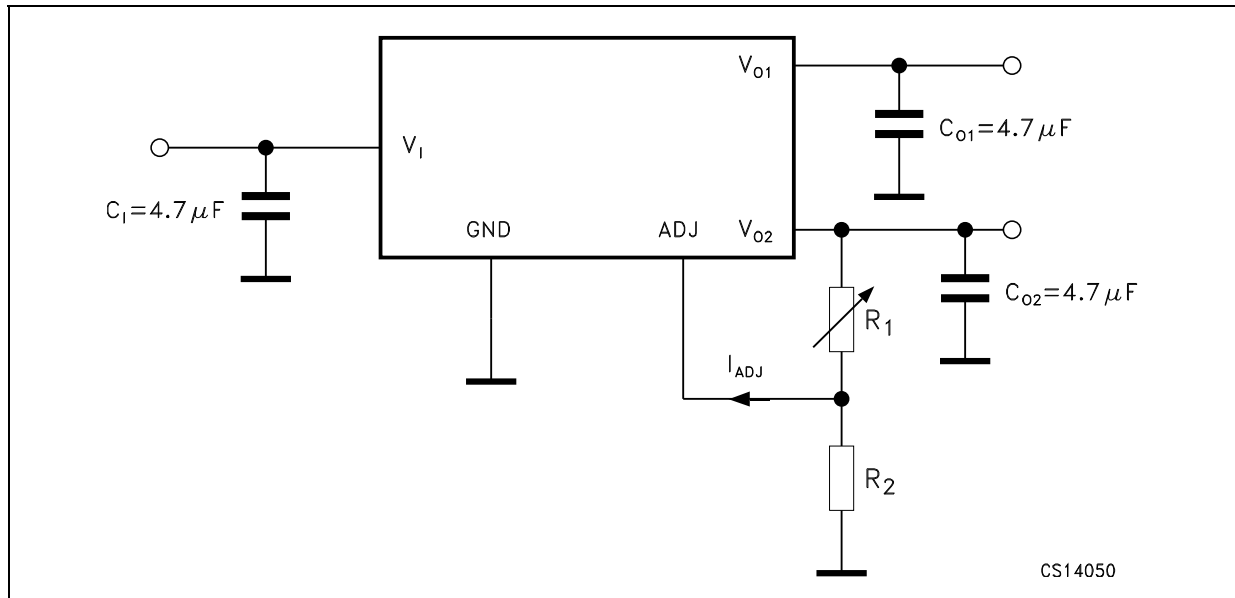

$$V_O = V_{REF} (1 + R_1 / R_2) + I_{ADJ}R_1$$

I_{ADJ} is very small (typically 35 μ A) and constant: in the V_O calculation it can be ignored.

7 Typical characteristics

Figure 5. Reference voltage vs. temperature

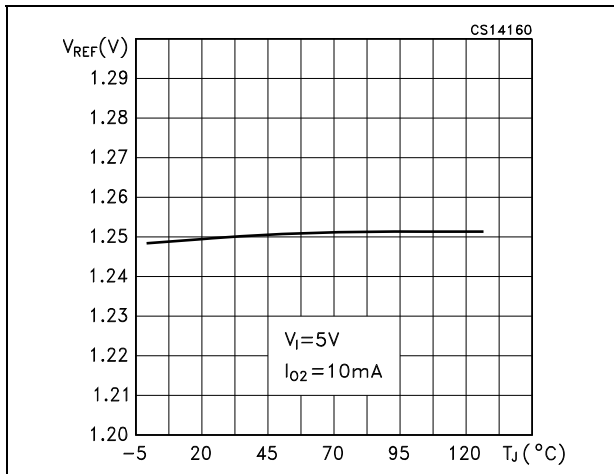

Figure 6. Reference line regulation vs. temperature

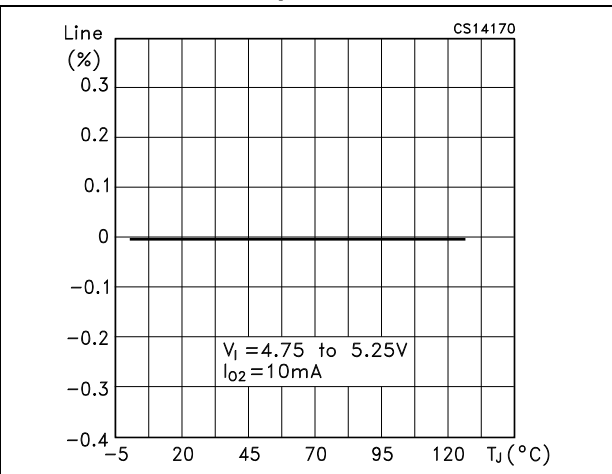

Figure 7. Reference load regulation vs. temperature

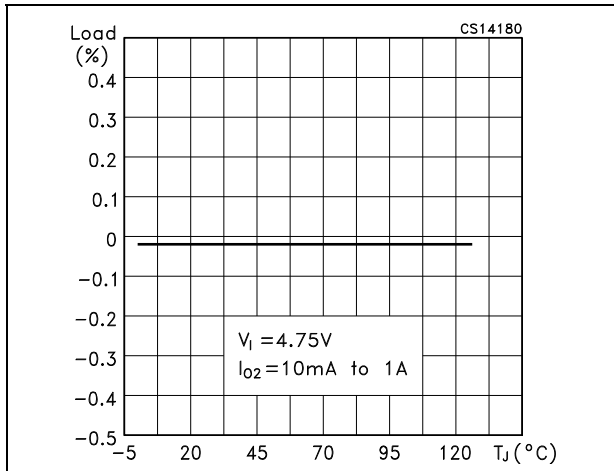

Figure 8. Reference voltage vs. input voltage

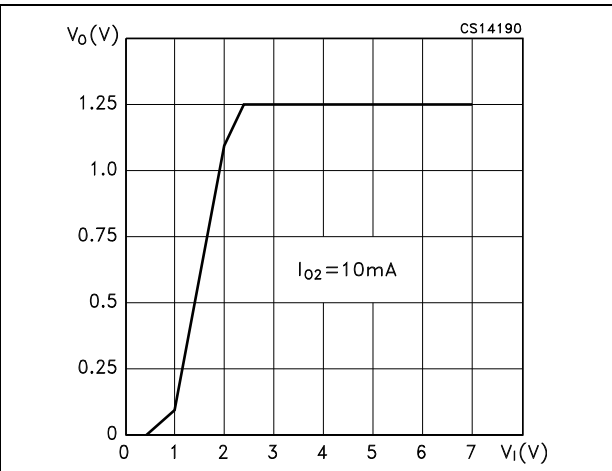

Figure 9. Dropout voltage vs. temperature (adjustable output)

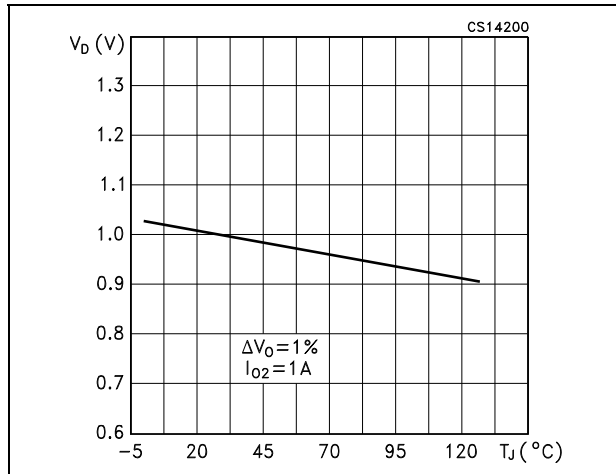

Figure 10. Dropout voltage vs. input voltage (adjustable output)

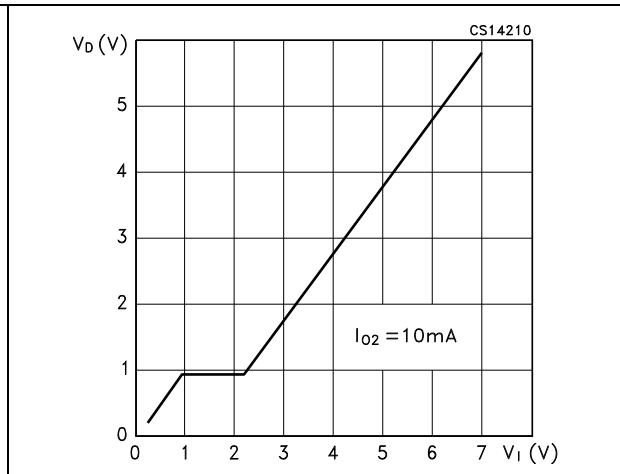

Figure 11. Minimum load current vs. temperature (adjustable output)

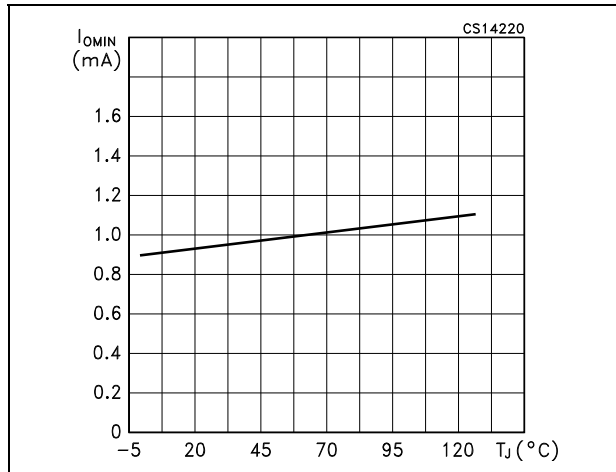

Figure 12. Adjust pin current vs. temperature (adjustable output)

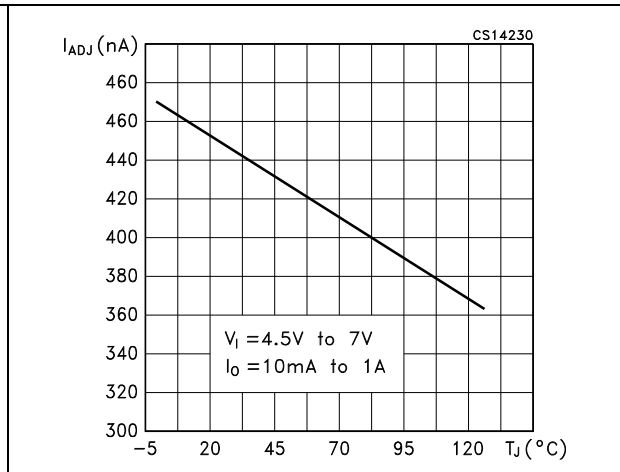

Figure 13. Output voltage vs. temperature

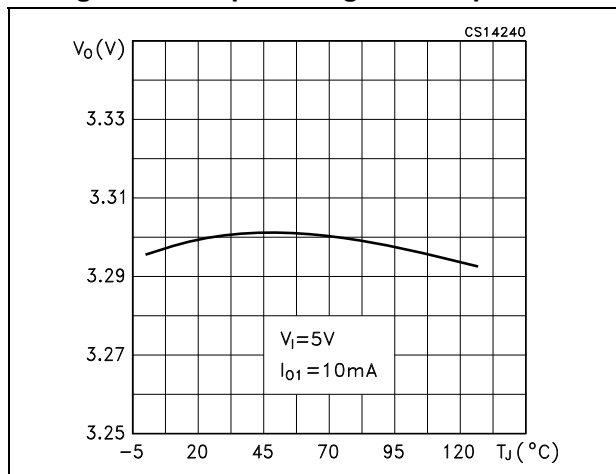

Figure 14. Line regulation vs. temperature

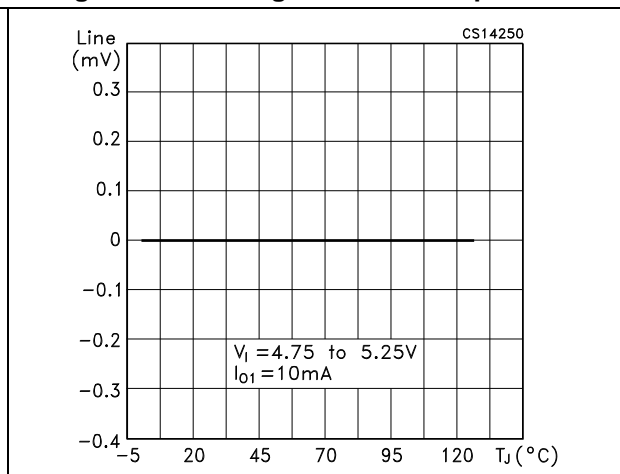

Figure 15. Load regulation vs. temperature

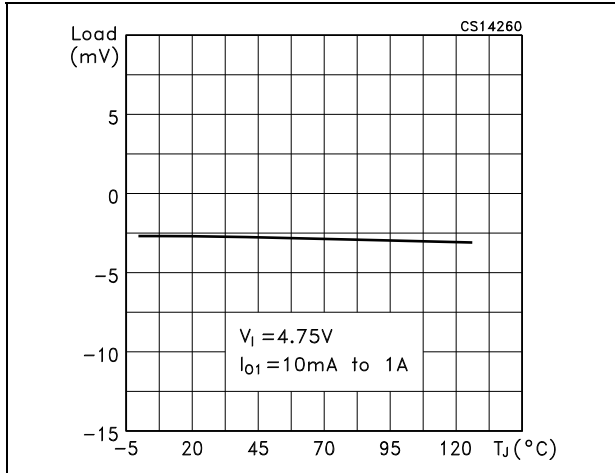

Figure 16. Output voltage vs. input voltage

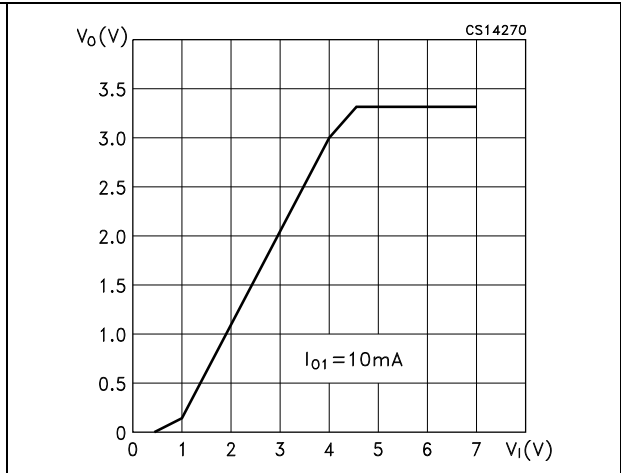

Figure 17. Dropout voltage vs. temperature (fixed output)

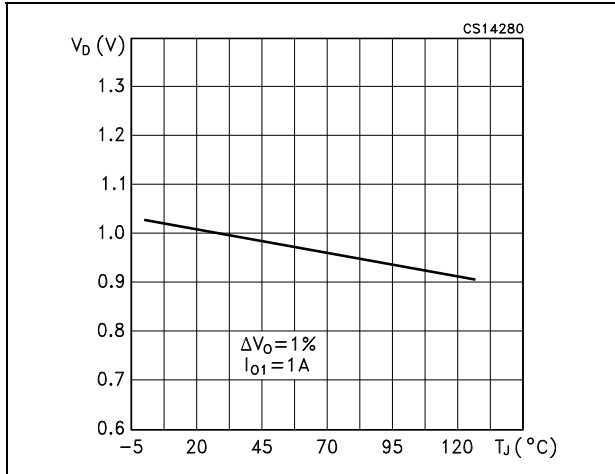

Figure 18. Dropout voltage vs. input voltage

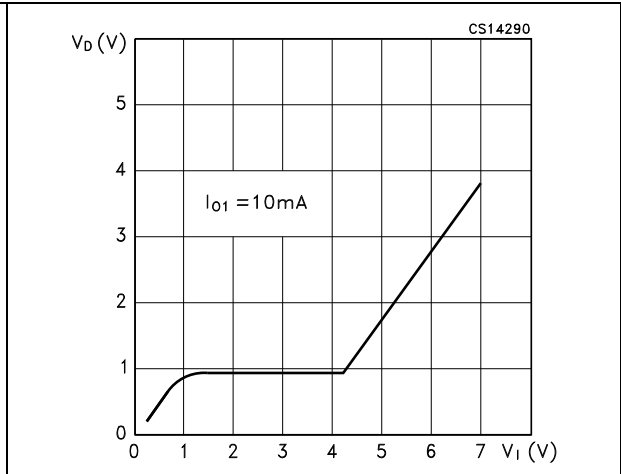

Figure 19. Supply voltage rejection vs. temperature

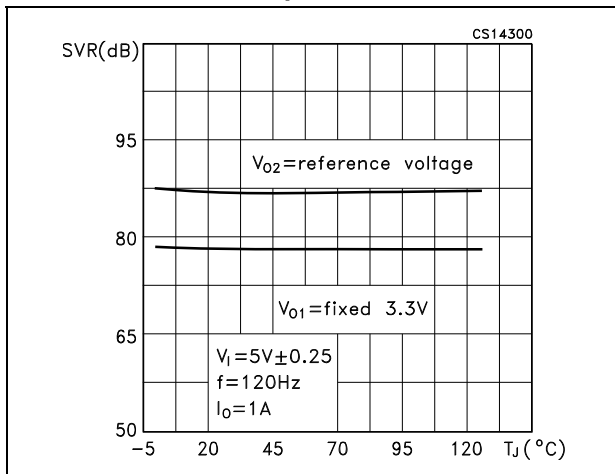

Figure 20. Supply voltage rejection vs. frequency

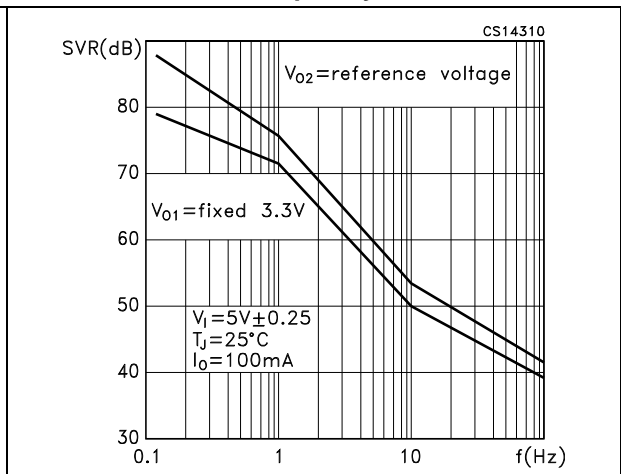

Figure 21. Quiescent current vs. temperature (fixed/adj. version)

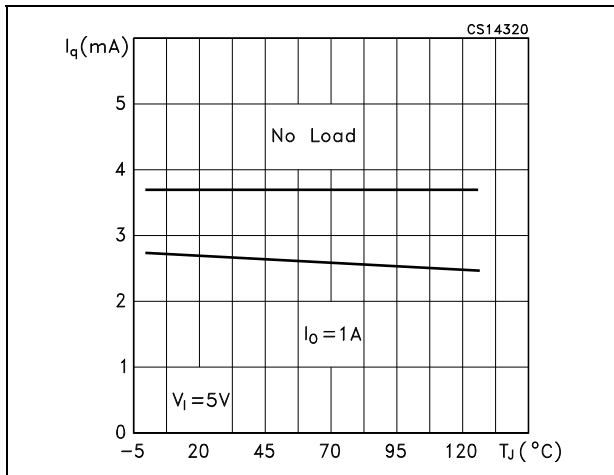

Figure 22. Quiescent current vs. temperature (fixed/fixed version)

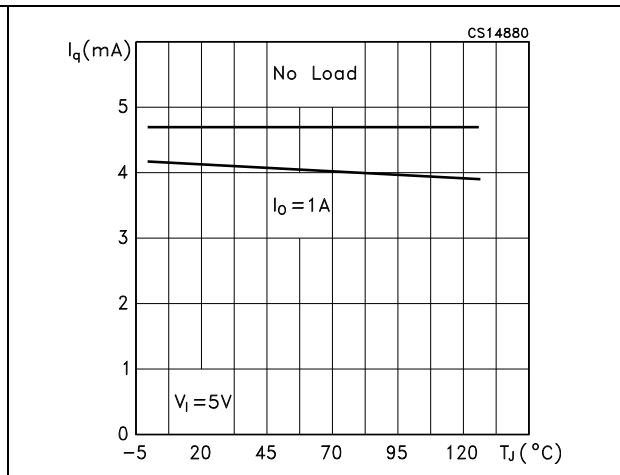

Figure 23. Short-circuit removal response

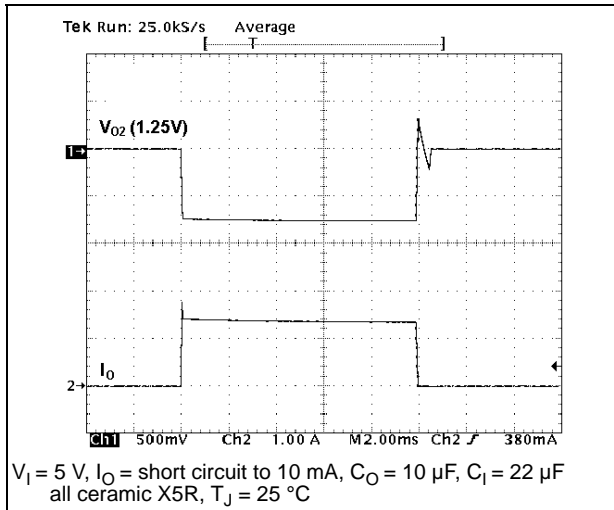

Figure 24. Change of V_O with step load change

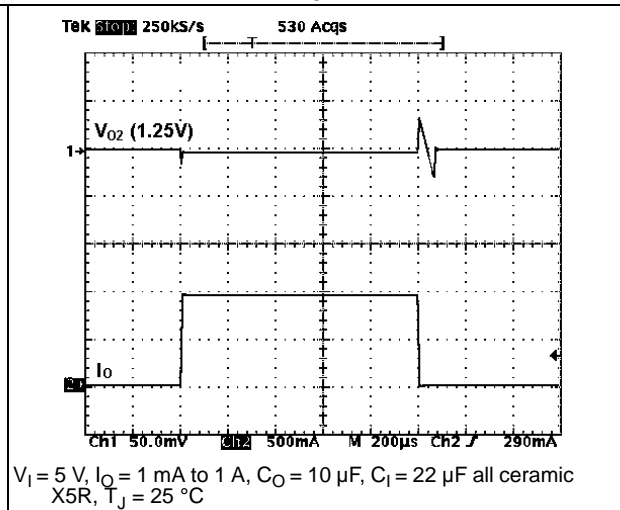

Figure 25. Change of V_O with step load change

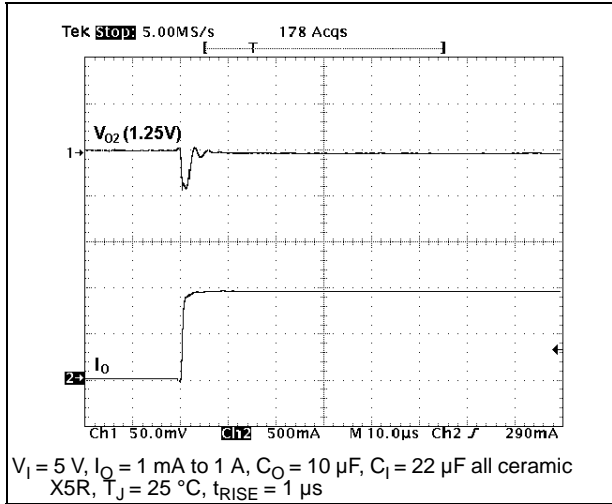

Figure 26. Change of V_O with step load change

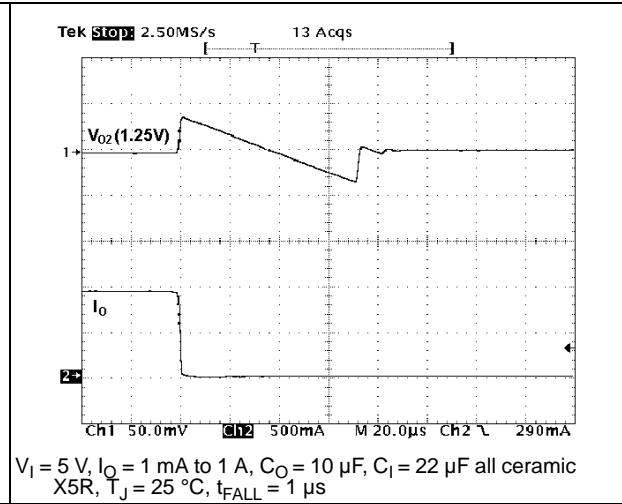

Figure 27. Short-circuit removal response

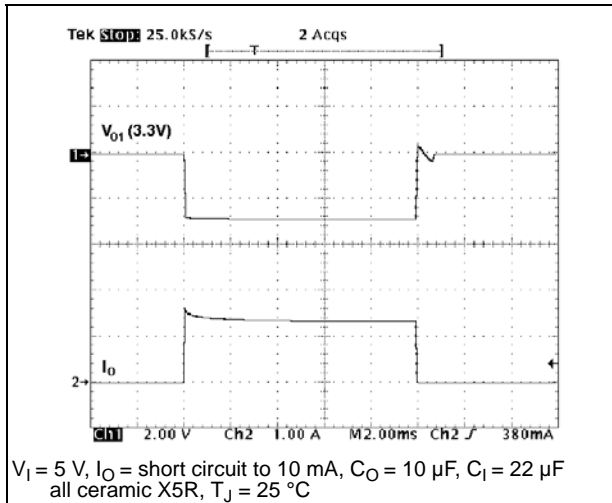

Figure 28. Change of V_O with step load change

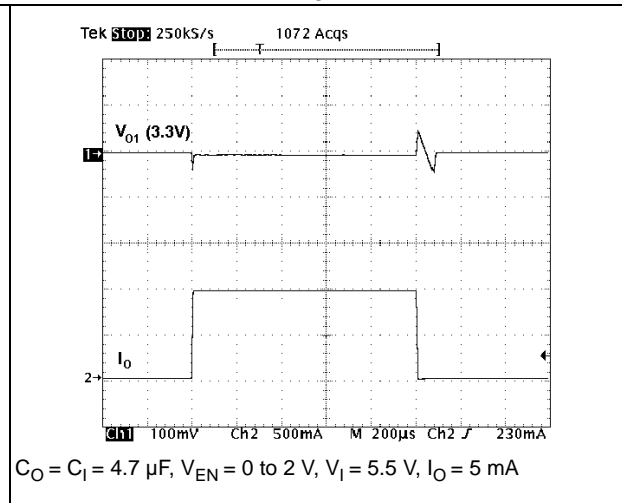

Figure 29. Change of V_O with step load change

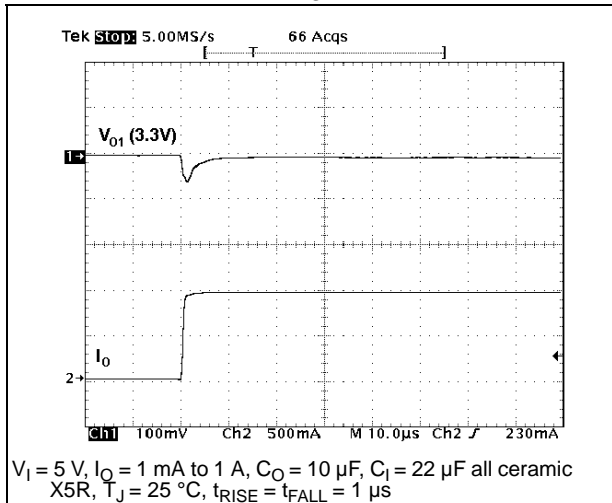

Figure 30. Change of V_O with step load change

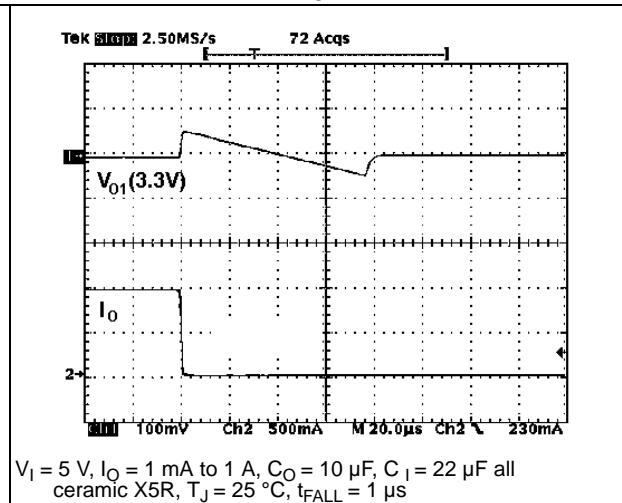

Figure 31. Start-up transient

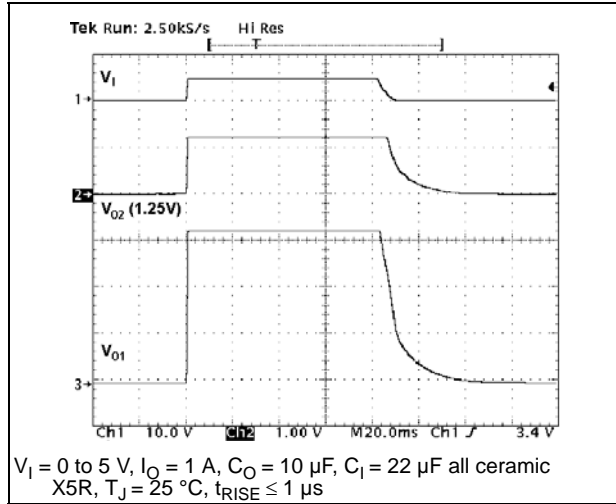
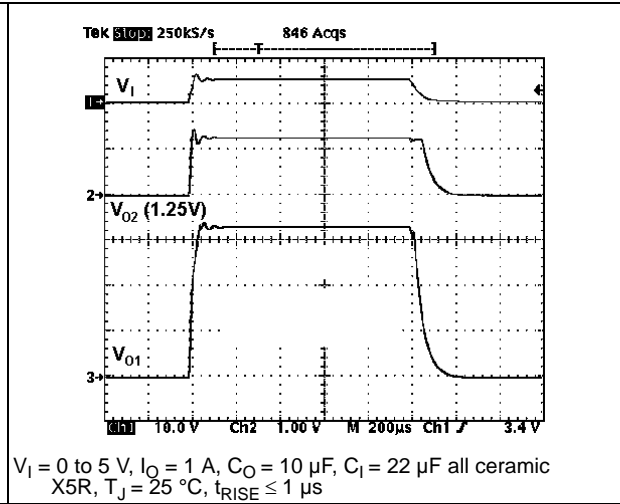

Figure 32. Start-up transient



8 Package mechanical data

In order to meet environmental requirements, ST offers these devices in different grades of ECOPACK® packages, depending on their level of environmental compliance. ECOPACK® specifications, grade definitions and product status are available at: www.st.com. ECOPACK is an ST trademark.

Figure 33. DFN8L (5 x 6 mm) drawing

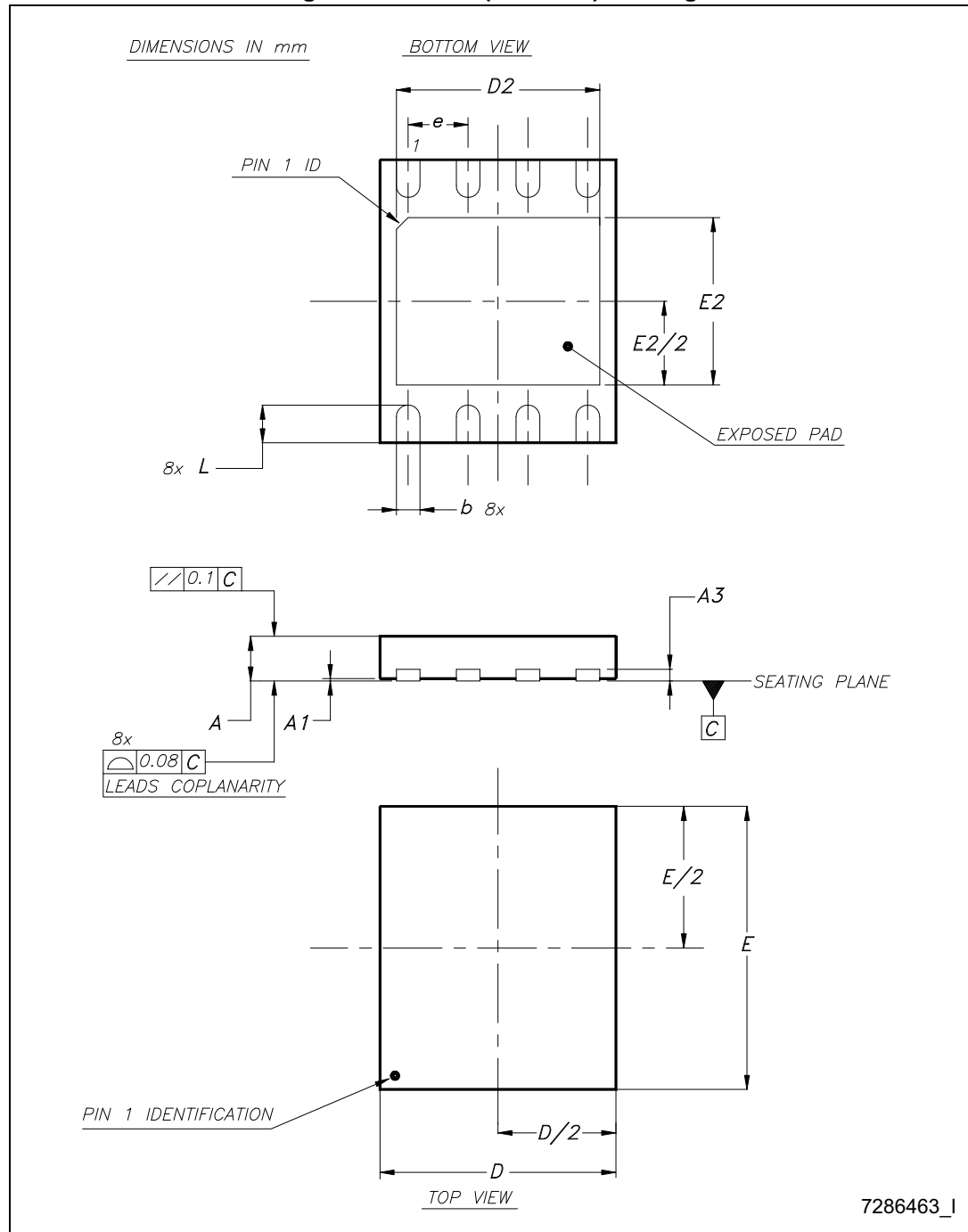
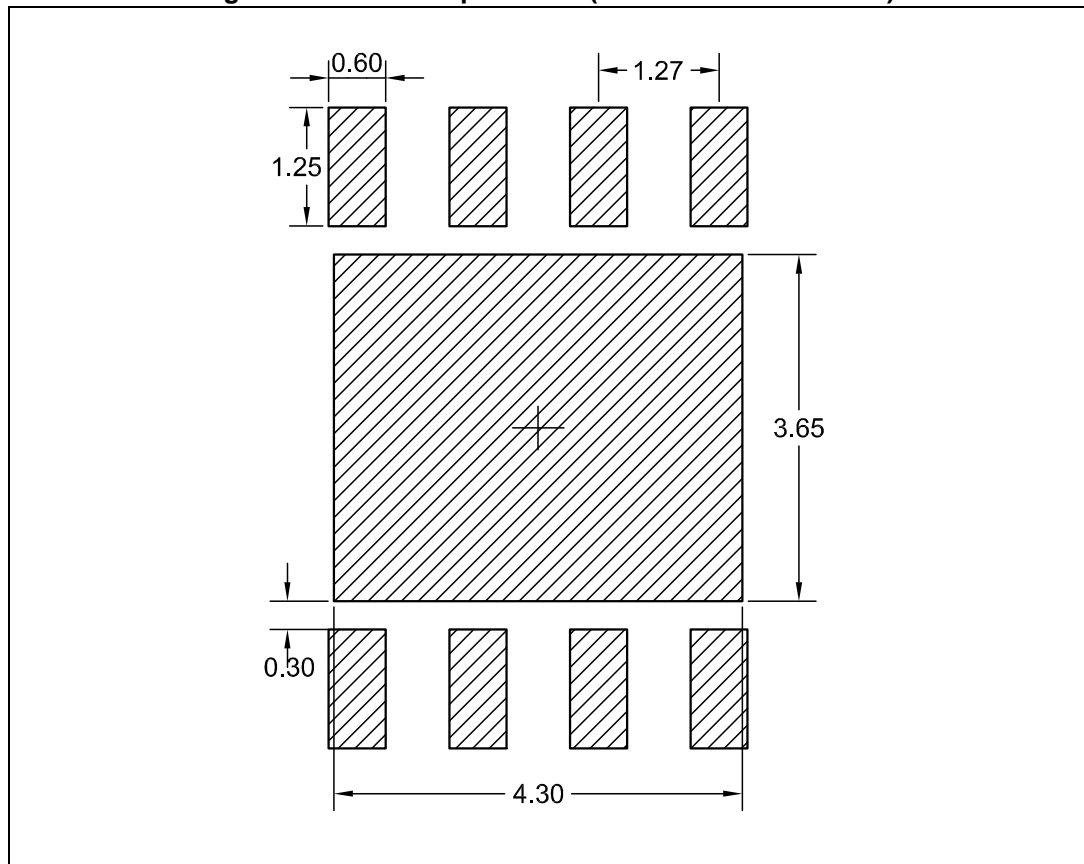

Table 14. DFN8 (5 x 6 mm) mechanical data

Dim.	mm		
	Min.	Typ.	Max.
A	0.80	0.90	1.00
A1	0	0.02	0.05
A3		0.20	
b	0.35	0.40	0.47
D		5.00	
D2	4.05	4.20	4.30
E		6.00	
E2	3.40	3.55	3.65
e		1.27	
L	0.70	0.80	0.90

Figure 34. DFN8 footprint data (dimensions are in mm.)



Tape and reel QFNxx/DFNxx (5x6 mm) mechanical data

Dim.	mm.			inch.		
	Min.	Typ.	Max.	Min.	Typ.	Max.
A			330			12.992
C	12.8		13.2	0.504		0.520
D	20.2			0.795		
N	99		101	3.898		3.976
T			14.4			0.567
Ao		5.30			0.209	
Bo		6.30			0.248	
Ko		1.20			0.047	
Po		4			0.157	
P		8			0.315	

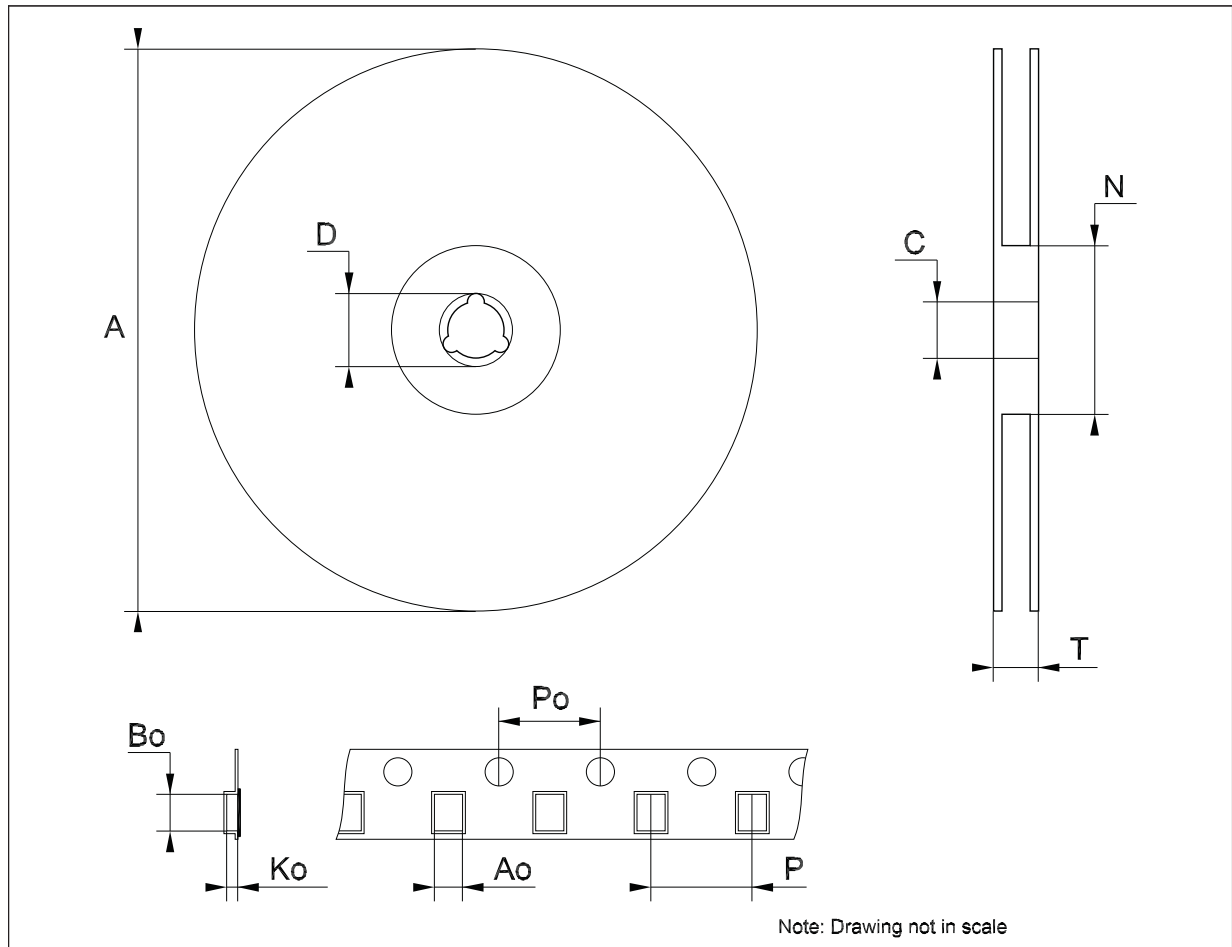

9 Different output voltage versions of the ST2L05-3300 available on request

Table 15. Options available on request

V_{O1}	V_{O2}	Order codes	Shipment
1.8 V	ADJ	ST2L05R1800PS	Tape and reel
2.5 V	ADJ	ST2L05R2500PS	Tape and reel
2.8 V	ADJ	ST2L05R2800PS	Tape and reel
3.0 V	1.5 V	ST2L05R3015PS	Tape and reel
3.0 V	ADJ	ST2L05R3000PS	Tape and reel

10 Revision history

Table 16. Document revision history

Date	Revision	Changes
18-Nov-2004	4	Removed PPAK version.
24-Nov-2004	5	Added new mechanical data.
06-Dec-2004	6	Modified mechanical data.
13-Feb-2009	7	Removed SPAK5-L version.
09-Oct-2018	8	Updated <i>Figure 33: DFN8L (5 x 6 mm) drawing</i> and <i>Table 14: DFN8 (5 x 6 mm) mechanical data.</i> Added <i>Figure 34: DFN8 footprint data (dimensions are in mm.)</i>

IMPORTANT NOTICE – PLEASE READ CAREFULLY

STMicroelectronics NV and its subsidiaries ("ST") reserve the right to make changes, corrections, enhancements, modifications, and improvements to ST products and/or to this document at any time without notice. Purchasers should obtain the latest relevant information on ST products before placing orders. ST products are sold pursuant to ST's terms and conditions of sale in place at the time of order acknowledgement.

Purchasers are solely responsible for the choice, selection, and use of ST products and ST assumes no liability for application assistance or the design of Purchasers' products.

No license, express or implied, to any intellectual property right is granted by ST herein.

Resale of ST products with provisions different from the information set forth herein shall void any warranty granted by ST for such product.

ST and the ST logo are trademarks of ST. All other product or service names are the property of their respective owners.

Information in this document supersedes and replaces information previously supplied in any prior versions of this document.

© 2018 STMicroelectronics – All rights reserved