



# STP80N70F6

N-channel 68 V, 0.0063  $\Omega$  typ., 96 A STripFET™ VI DeepGATE™ Power MOSFET in TO-220 package

Datasheet – production data

## Features

Order code	V <sub>DSS</sub> max.	R <sub>DS(on)</sub> max.	I <sub>D</sub>	P <sub>TOT</sub>
STP80N70F6	68 V	< 0.008 $\Omega$ (V <sub>GS</sub> = 10 V)	96 A	110 W

- R<sub>DS(on)</sub> \* Q<sub>g</sub> industry benchmark
- Extremely low on-resistance R<sub>DS(on)</sub>
- High avalanche ruggedness
- Low gate drive power losses
- Very low switching gate charge

## Applications

- Switching applications

## Description

This device is an N-channel Power MOSFET developed using the 6<sup>th</sup> generation of STripFET™ DeepGATE™ technology, with a new gate structure. The resulting Power MOSFET exhibits the lowest R<sub>DS(on)</sub> in all packages.

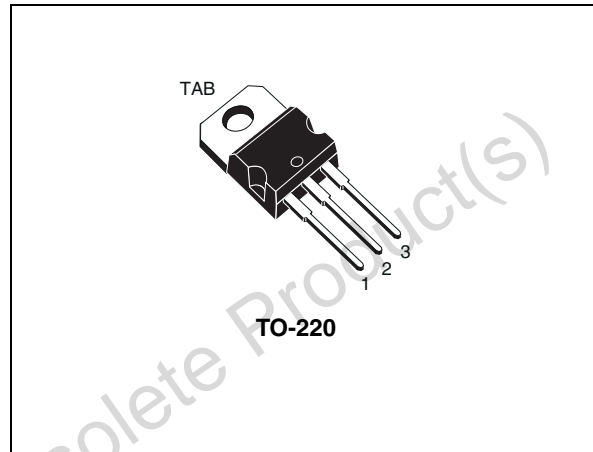

Figure 1. Internal schematic diagram

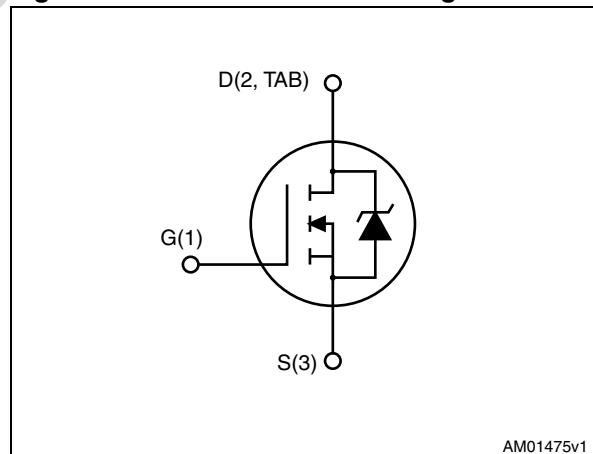

Table 1. Device summary

Order code	Marking	Package	Packaging
STP80N70F6	80N70F6	TO-220	Tube

# Contents

<b>1</b>	<b>Electrical ratings</b> .....	<b>3</b>
<b>2</b>	<b>Electrical characteristics</b> .....	<b>4</b>
	2.1 Electrical characteristics (curves) .....	6
<b>3</b>	<b>Test circuits</b> .....	<b>8</b>
<b>4</b>	<b>Package mechanical data</b> .....	<b>9</b>
<b>5</b>	<b>Revision history</b> .....	<b>12</b>

Obsolete Product(s) - Obsolete Product(s)

# 1 Electrical ratings

**Table 2. Absolute maximum ratings**

Symbol	Parameter	Value	Unit
$V_{DS}$	Drain-source voltage	68	V
$V_{GS}$	Gate-source voltage	$\pm 20$	V
$I_D^{(1)}$	Drain current (continuous) at $T_C = 25\text{ }^\circ\text{C}$	96	A
$I_D^{(1)}$	Drain current (continuous) at $T_C = 100\text{ }^\circ\text{C}$	60	A
$I_{DM}^{(1)}$	Drain current (pulsed)	384	A
$P_{TOT}^{(1)}$	Total dissipation at $T_C = 25\text{ }^\circ\text{C}$	110	W
$T_{stg}$	Storage temperature	- 55 to 175	$^\circ\text{C}$
$T_j$	Operating junction temperature		

1. This value is rated according to  $R_{thj-c}$

**Table 3. Thermal data**

Symbol	Parameter	Value	Unit
$R_{thj-c}$	Thermal resistance junction-case max	1.36	$^\circ\text{C/W}$
$R_{thj-a}$	Thermal resistance junction-ambient max	62.5	$^\circ\text{C/W}$

## 2 Electrical characteristics

( $T_{CASE} = 25\text{ °C}$  unless otherwise specified).

**Table 4. On/off states**

Symbol	Parameter	Test conditions	Min.	Typ.	Max.	Unit
$V_{(BR)DSS}$	Drain-source breakdown voltage ( $V_{GS} = 0$ )	$I_D = 250\ \mu\text{A}$	68			V
$I_{DSS}$	Zero gate voltage	$V_{DS} = 68\ \text{V}$			1	$\mu\text{A}$
	Drain current ( $V_{GS} = 0$ )	$V_{DS} = 68\ \text{V}, T_C = 125\text{ °C}$			100	$\mu\text{A}$
$I_{GSS}$	Gate-body leakage current ( $V_{DS} = 0$ )	$V_{GS} = \pm 20\ \text{V}$			$\pm 100$	nA
$V_{GS(th)}$	Gate threshold voltage	$V_{DS} = V_{GS}, I_D = 250\ \mu\text{A}$	2		4	V
$R_{DS(on)}$	Static drain-source on-resistance	$V_{GS} = 10\ \text{V}, I_D = 48\ \text{A}$		0.0063	0.008	$\Omega$

**Table 5. Dynamic**

Symbol	Parameter	Test conditions	Min.	Typ.	Max.	Unit
$C_{iss}$	Input capacitance			5850		pF
$C_{oss}$	Output capacitance	$V_{DS} = 25\ \text{V}, f = 1\ \text{MHz}, V_{GS} = 0$	-	341	-	pF
$C_{rss}$	Reverse transfer capacitance				240	
$Q_g$	Total gate charge	$V_{DD} = 34\ \text{V}, I_D = 96\ \text{A}, V_{GS} = 10\ \text{V}$ (see Figure 14)		99		nC
$Q_{gs}$	Gate-source charge			31		nC
$Q_{gd}$	Gate-drain charge			19		nC

**Table 6. Switching times**

Symbol	Parameter	Test conditions	Min.	Typ.	Max.	Unit
$t_{d(on)}$ $t_r$	Turn-on delay time	$V_{DD} = 10\ \text{V}, I_D = 48\ \text{A}, R_G = 4.7\ \Omega, V_{GS} = 10\ \text{V}$ (see Figure 13)	-	23	-	ns
	Rise time			29		ns
$t_{d(off)}$ $t_f$	Turn-off-delay time			-	102	-
	Fall time			23		ns

**Table 7. Source drain diode**

Symbol	Parameter	Test conditions	Min.	Typ.	Max	Unit
$I_{SD}$	Source-drain current		-		96	A
$I_{SDM}^{(1)}$	Source-drain current (pulsed)		-		384	A
$V_{SD}^{(2)}$	Forward on voltage	$I_{SD} = 96 \text{ A}, V_{GS} = 0$	-		1.5	V
$t_{rr}$	Reverse recovery time	$I_{SD} = 48 \text{ A}, V_{DD} = 24 \text{ V}$ $di/dt = 100 \text{ A}/\mu\text{s},$ $T_j = 150 \text{ }^\circ\text{C}$ <i>(see Figure 15)</i>	-	34		ns
$Q_{rr}$	Reverse recovery charge			53		nC
$I_{RRM}$	Reverse recovery current			3		A

1. Pulse width is limited by safe operating area
2. Pulsed: pulse duration = 300  $\mu\text{s}$ , duty cycle 1.5%

## 2.1 Electrical characteristics (curves)

Figure 2. Safe operating area

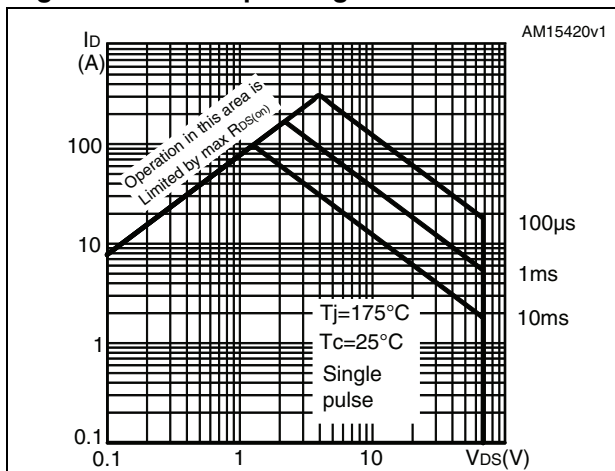

Figure 3. Thermal impedance

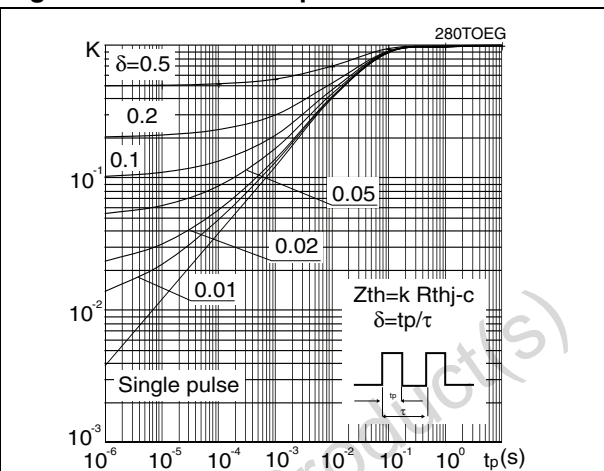

Figure 4. Output characteristics

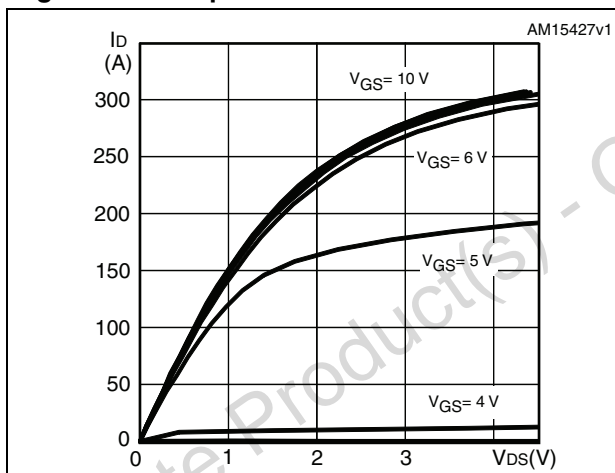

Figure 5. Transfer characteristics

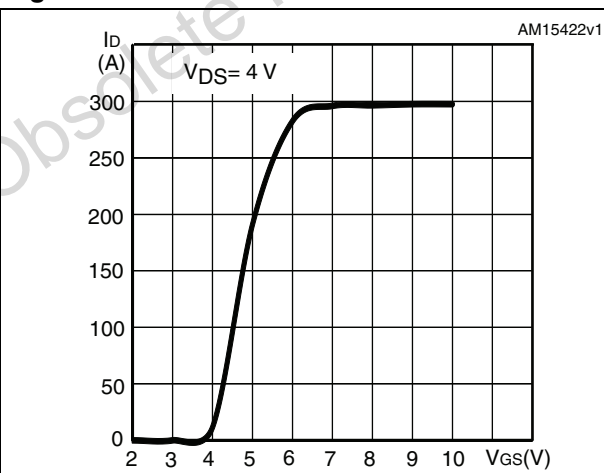

Figure 6. Gate charge vs gate-source voltage

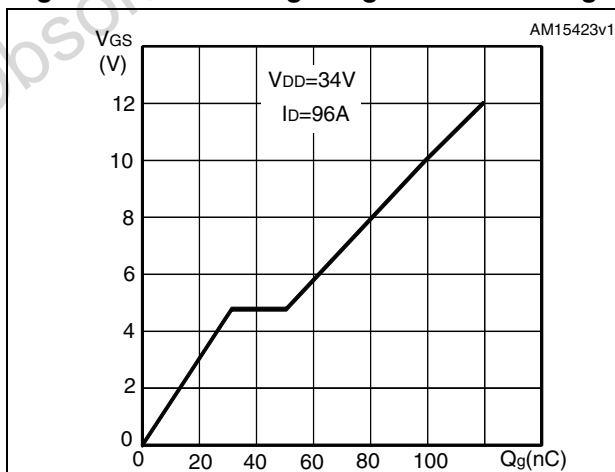

Figure 7. Static drain-source on-resistance

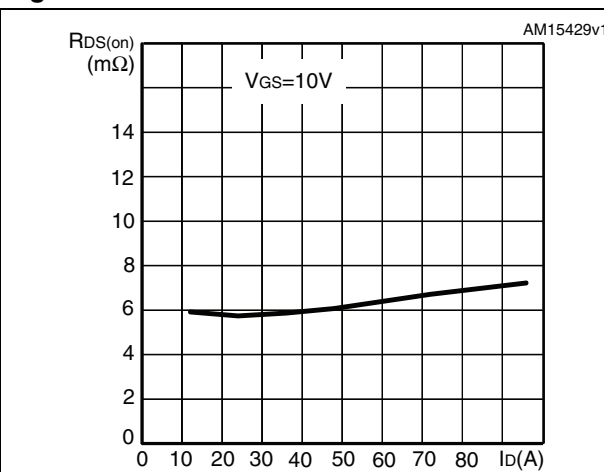

Figure 8. Capacitance variations

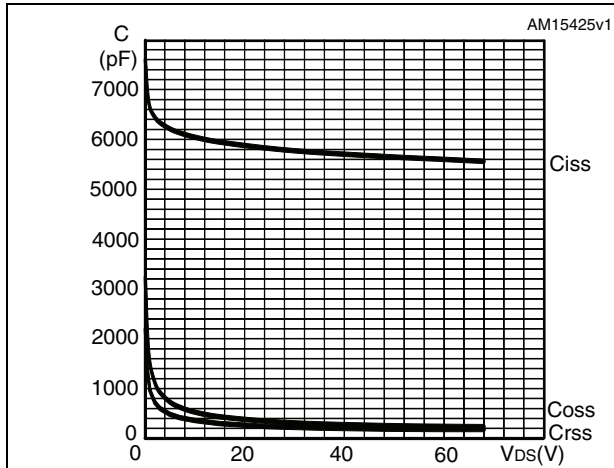

Figure 9. Normalized  $B_{VDSS}$  vs temperature

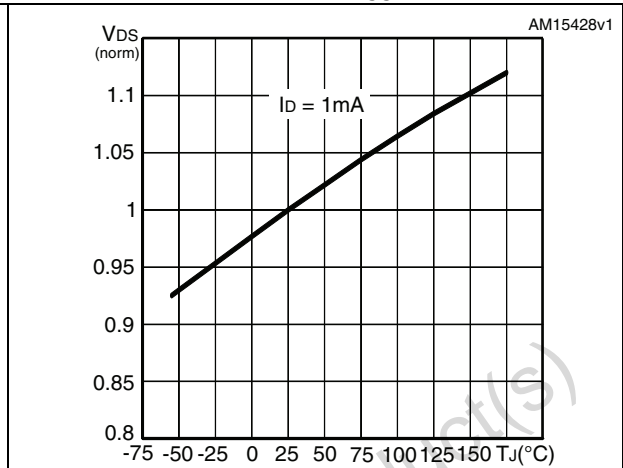

Figure 10. Normalized gate threshold voltage vs temperature

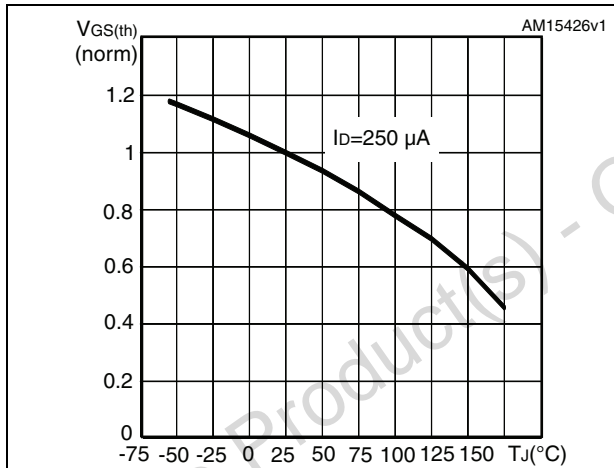

Figure 11. Normalized on-resistance vs temperature

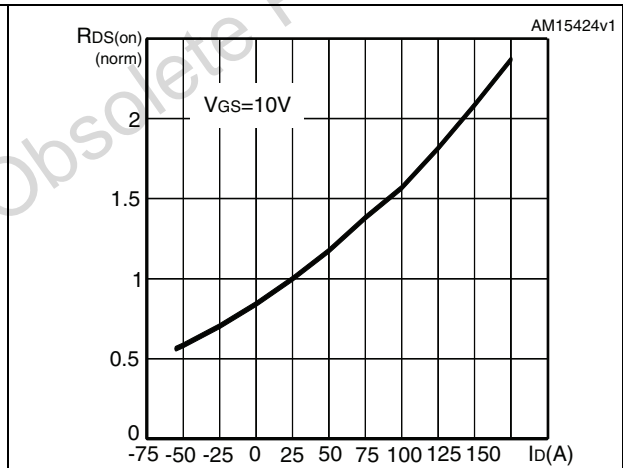
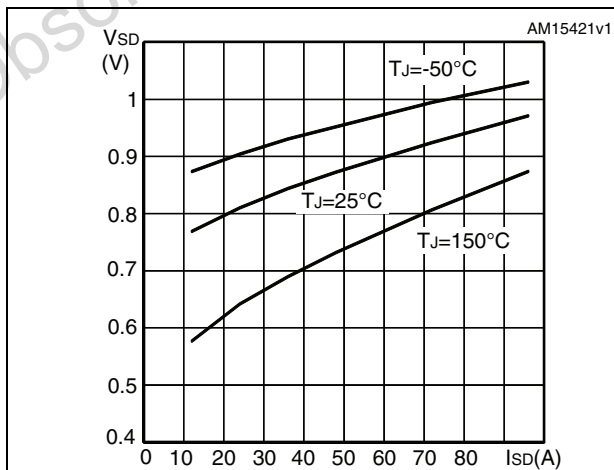

Figure 12. Source-drain diode forward characteristics







## 4 Package mechanical data

In order to meet environmental requirements, ST offers these devices in different grades of ECOPACK® packages, depending on their level of environmental compliance. ECOPACK® specifications, grade definitions and product status are available at: [www.st.com](http://www.st.com). ECOPACK® is an ST trademark.

Obsolete Product(s) - Obsolete Product(s)

Table 8. TO-220 type A mechanical data

Dim.	mm		
	Min.	Typ.	Max.
A	4.40		4.60
b	0.61		0.88
b1	1.14		1.70
c	0.48		0.70
D	15.25		15.75
D1		1.27	
E	10		10.40
e	2.40		2.70
e1	4.95		5.15
F	1.23		1.32
H1	6.20		6.60
J1	2.40		2.72
L	13		14
L1	3.50		3.93
L20		16.40	
L30		28.90	
ØP	3.75		3.85
Q	2.65		2.95

Figure 19. TO-220 type A drawing

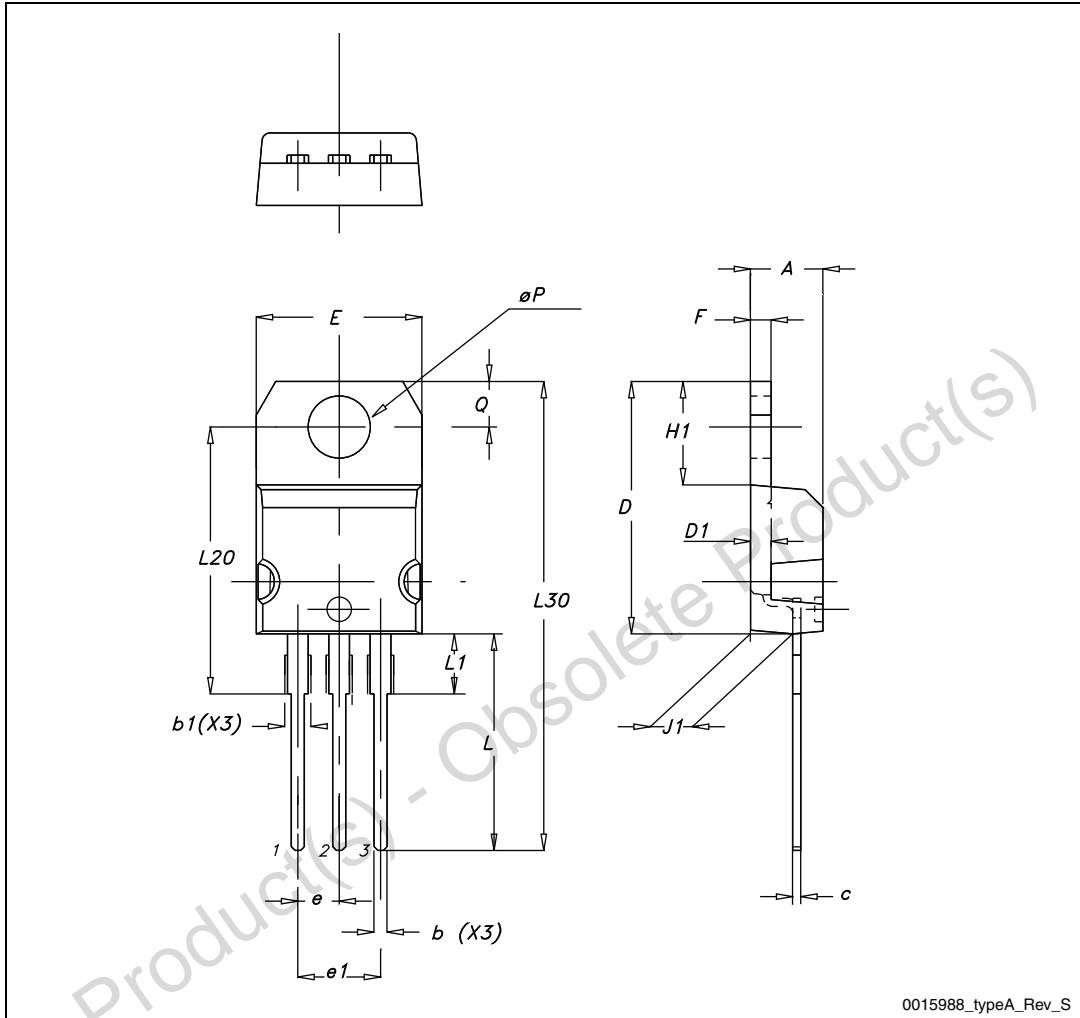

0015988\_typeA\_Rev\_S

## 5 Revision history

Table 9. Document revision history

Date	Revision	Changes
06-Dec-2012	1	First release.

Obsolete Product(s) - Obsolete Product(s)

**Please Read Carefully:**

Information in this document is provided solely in connection with ST products. STMicroelectronics NV and its subsidiaries ("ST") reserve the right to make changes, corrections, modifications or improvements, to this document, and the products and services described herein at any time, without notice.

All ST products are sold pursuant to ST's terms and conditions of sale.

Purchasers are solely responsible for the choice, selection and use of the ST products and services described herein, and ST assumes no liability whatsoever relating to the choice, selection or use of the ST products and services described herein.

No license, express or implied, by estoppel or otherwise, to any intellectual property rights is granted under this document. If any part of this document refers to any third party products or services it shall not be deemed a license grant by ST for the use of such third party products or services, or any intellectual property contained therein or considered as a warranty covering the use in any manner whatsoever of such third party products or services or any intellectual property contained therein.

**UNLESS OTHERWISE SET FORTH IN ST'S TERMS AND CONDITIONS OF SALE ST DISCLAIMS ANY EXPRESS OR IMPLIED WARRANTY WITH RESPECT TO THE USE AND/OR SALE OF ST PRODUCTS INCLUDING WITHOUT LIMITATION IMPLIED WARRANTIES OF MERCHANTABILITY, FITNESS FOR A PARTICULAR PURPOSE (AND THEIR EQUIVALENTS UNDER THE LAWS OF ANY JURISDICTION), OR INFRINGEMENT OF ANY PATENT, COPYRIGHT OR OTHER INTELLECTUAL PROPERTY RIGHT.**

**UNLESS EXPRESSLY APPROVED IN WRITING BY TWO AUTHORIZED ST REPRESENTATIVES, ST PRODUCTS ARE NOT RECOMMENDED, AUTHORIZED OR WARRANTED FOR USE IN MILITARY, AIR CRAFT, SPACE, LIFE SAVING, OR LIFE SUSTAINING APPLICATIONS, NOR IN PRODUCTS OR SYSTEMS WHERE FAILURE OR MALFUNCTION MAY RESULT IN PERSONAL INJURY, DEATH, OR SEVERE PROPERTY OR ENVIRONMENTAL DAMAGE. ST PRODUCTS WHICH ARE NOT SPECIFIED AS "AUTOMOTIVE GRADE" MAY ONLY BE USED IN AUTOMOTIVE APPLICATIONS AT USER'S OWN RISK.**

Resale of ST products with provisions different from the statements and/or technical features set forth in this document shall immediately void any warranty granted by ST for the ST product or service described herein and shall not create or extend in any manner whatsoever, any liability of ST.

ST and the ST logo are trademarks or registered trademarks of ST in various countries.

Information in this document supersedes and replaces all information previously supplied.

The ST logo is a registered trademark of STMicroelectronics. All other names are the property of their respective owners.

© 2012 STMicroelectronics - All rights reserved

STMicroelectronics group of companies

Australia - Belgium - Brazil - Canada - China - Czech Republic - Finland - France - Germany - Hong Kong - India - Israel - Italy - Japan - Malaysia - Malta - Morocco - Philippines - Singapore - Spain - Sweden - Switzerland - United Kingdom - United States of America

[www.st.com](http://www.st.com)

